

STEP 6

Position of the shaft
Position de l'axe
Posición del eje

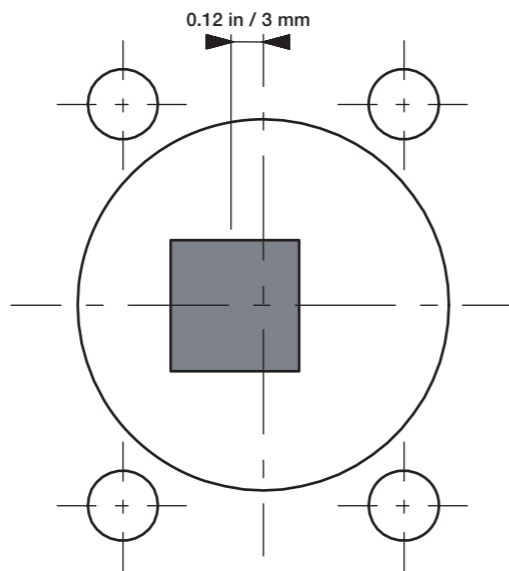
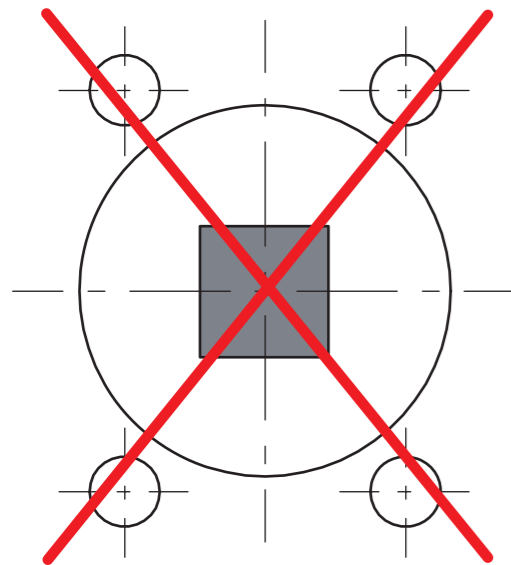
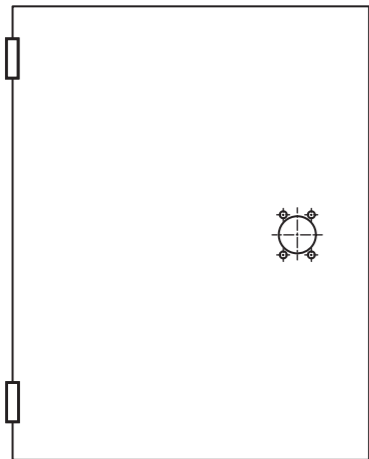

COOPER

Bussmann™

**NFPA79 KIT FOR 600A & 800A
 UL 98 FUSIBLE DISCONNECT SWITCHES**

⚠ DANGER / DANGER / PELIGRO

HAZARDOUS VOLTAGE

- This equipment must be installed and serviced only by qualified electrical personnel.
- Turn off all power supplying this equipment before working on or inside equipment.
- Always use a properly rated voltage sensing device to confirm power is OFF.
- Replace all devices, doors, and covers before turning on power to this equipment.
- Maintain electrical clearances between cable and live parts.

Failure to follow these instructions will result in death or serious injury.

TENSION DANGEREUSE

- L'installation et l'entretien de cet appareil ne doivent être effectués que par du personnel qualifié.
- Coupez l'alimentation de cet appareil avant d'y travailler.
- Utilisez toujours un dispositif de détection de tension à valeur nominale approprié pour confirmer que toute alimentation est coupée.
- Remplacez tous les dispositifs, les portes et les couvercles avant de mettre cet appareil sous tension.
- Maintenez les distances d'isolement électrique entre le câble et les pièces sous tension.

Si ces précautions ne sont pas respectées, cela entraînera la mort ou des blessures graves.

TENSION PELIGROSA

- Solamente el personal de mantenimiento eléctrico especializado deberá instalar y prestar servicios de mantenimiento a este equipo.
- Desenergice el equipo antes de realizar cualquier trabajo en él.
- Siempre utilice un dispositivo detector de tensión adecuado para confirmar la desenergización del equipo.
- Vuelva a colocar todos los dispositivos, las puertas y las cubiertas antes de energizar este equipo.
- Mantenga un espacio adecuado para la instalación eléctrica entre el cable y las piezas energizadas.

El incumplimiento de estas precauciones podrá causar la muerte o lesiones serias.

NFPA kit
Kit NFPA
Opción NFPA

Kit ref : H79-4

USED WITH
 UTILISER AVEC
 UTILIZACIÓN CON

RDF600J-2 / RDF600J-3 / RDF600J-4
 RDF800J-2 / RDF800J-3 / RDF800J-4

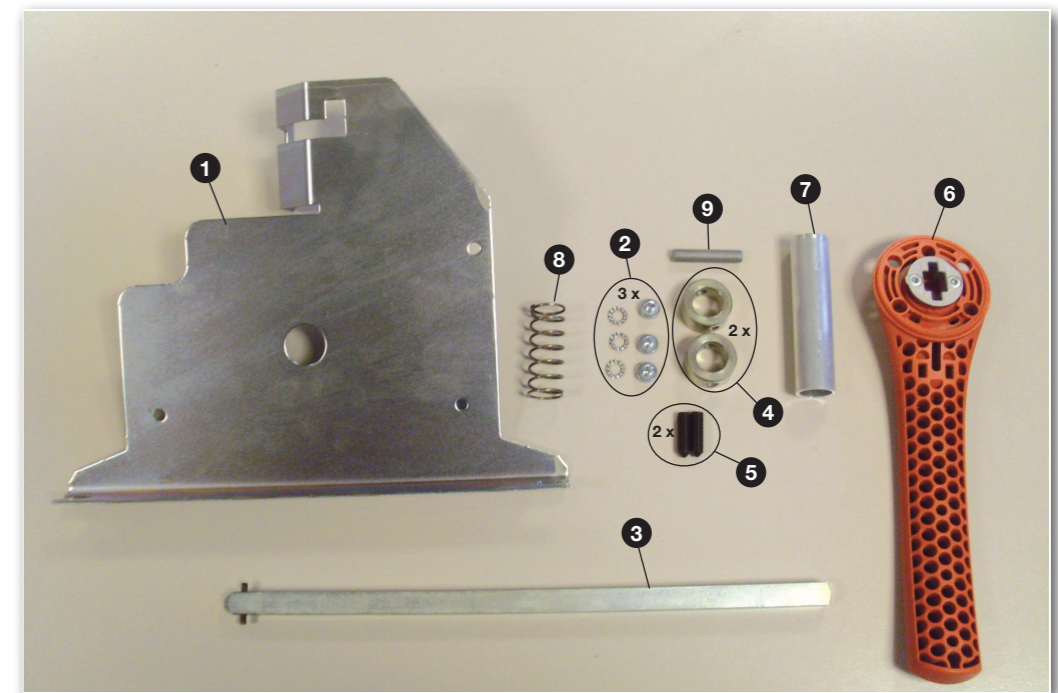

STEP 1

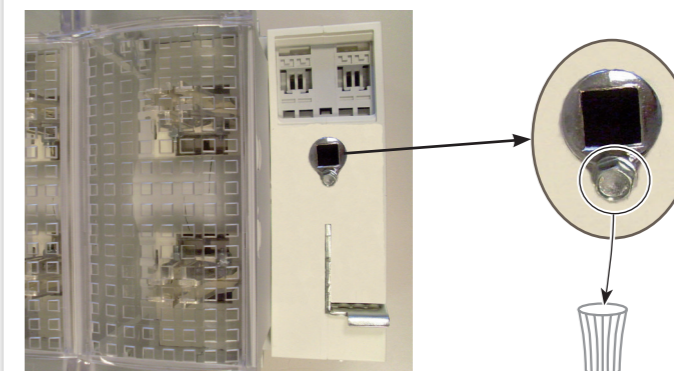

STEP 2

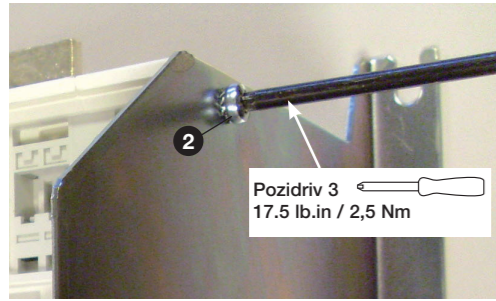
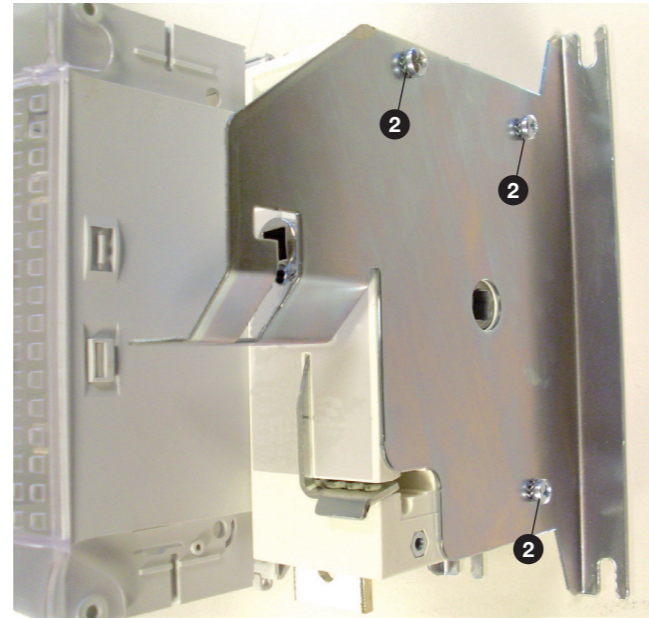
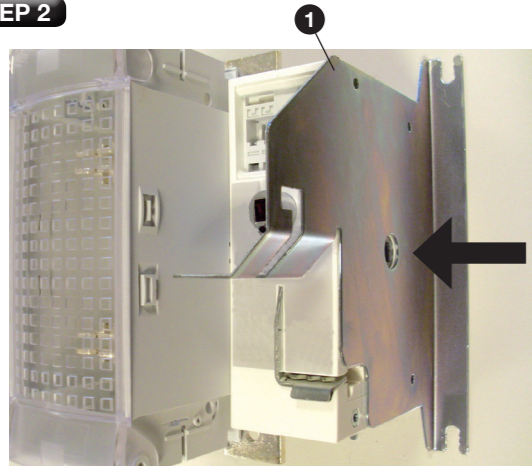

STEP 3

Tighten a little
Pré visser
Atornillar un poco

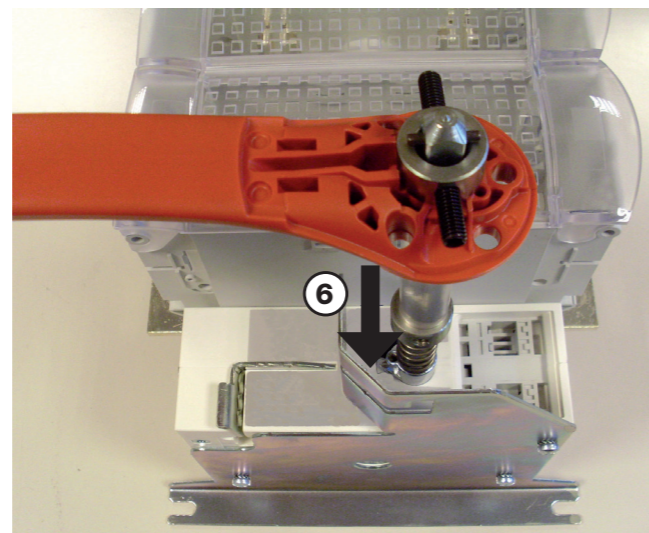
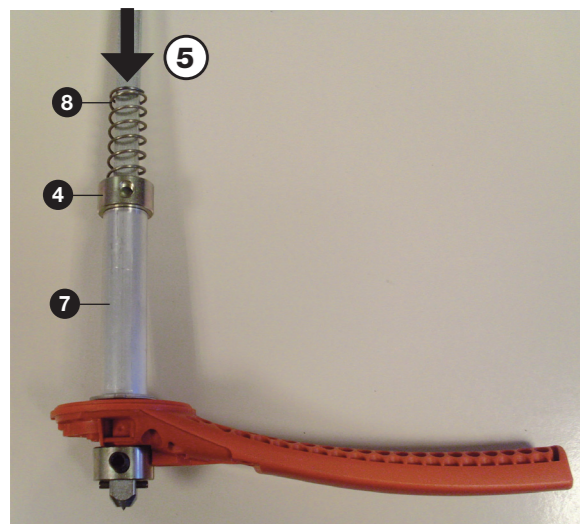
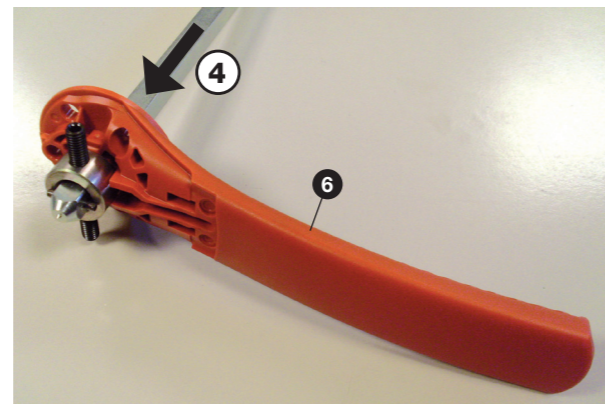
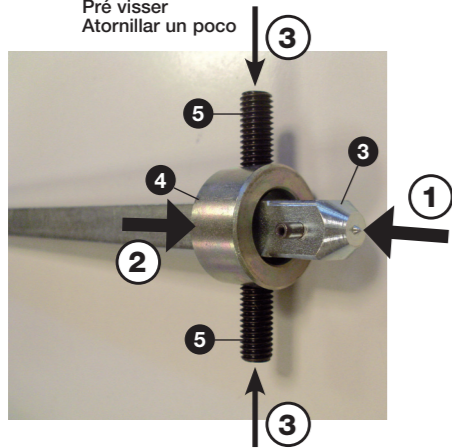

STEP 4

Shaft length
Longueur d'axe
Longitud del eje

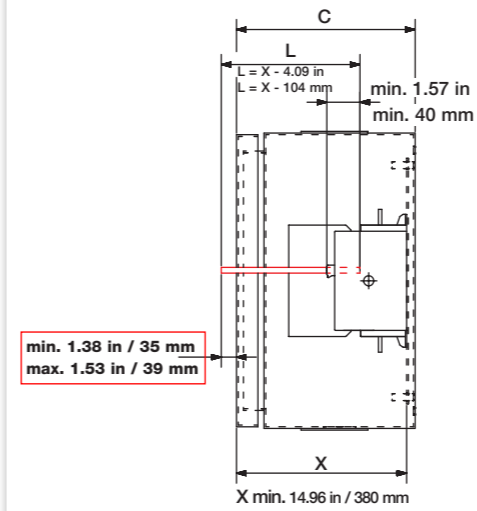

Set the position of the shaft
Régler la position de l'axe
Reglar la posición del eje

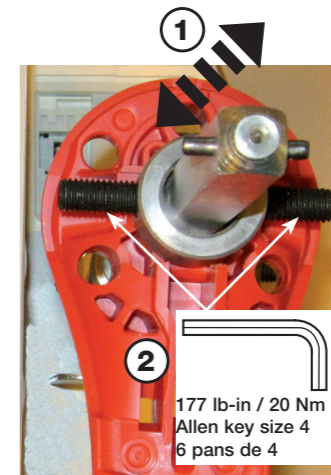

STEP 5

