

# Specifications

Drawing No.	K1101-12330-371 1/11
Issued Date.	Jun,01,2012

**TO: Digi-key**

---

**Note: In case of specification change, KYOCERA Part Number also will be changed.**



Product Name	Quartz Crystal
Product Model	CX2016DB
Frequency	39062.5kHz
Customer Part Number	-
Customer Specification Number	-
KYOCERA Part Number	CX2016DB39062K0KJSC1
Remarks	Pb-Free, RoHS Compliant, MSL 1

**Customer Acceptance**

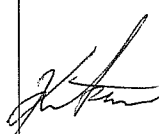
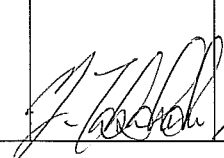

Accept Signature	Approved Date	
	Department	
	Person in charge	

**Seller**  
**KYOCERA Corporation**  
 (Electronic Components Sales Division)  
 6 Takeda Tobadono-cho, Fushimi-ku, Kyoto  
 612-8501 Japan  
 TEL. No. 075-604-3500  
 FAX. No. 075-604-3501

**Manufacturer**  
**KYOCERA Crystal Device Corporation**  
 (Marketing & Sales Engineering Division)  
 1-8-1, Izumi-hontyo, Komae-shi, Tokyo  
 201-8648 Japan  
 TEL. No. 03-5497-3111  
 FAX. No. 03-5497-3209

Design Department	Quality Assurance	Approved by	Checked by	Issued by
KYOCERA Crystal Device Yamagata Corporation Crystal Design Section Crystal Units Division 1				

### Revision History

Rev.No.	Description of revise	Date	Approved by	Checked by	Issued by
1	First Edition	Jun,01,2012			

**1. APPLICATION**

This specification sheet is applied to quartz crystal "CX2016DB"

**2. KKC PART NUMBER**

CX2016DB39062K0KJSC1

**3. RATINGS**

Items	SYMB.	Rating	Unit	Remarks
Operating Temperature	Topr	-30~+75	°C	
Storage Temperature range	Tstg	-40~+85	°C	

**4. CHARACTERISTICS****ELECTRICAL CHARACTERISTICS**

Items	Electrical Specification					Test Condition	Remarks
	SYMB.	Min	Typ.	Max	Unit		
Mode of Vibration		Fundamental					
Nominal Frequency	F0		39.0625		MHz		
Nominal Temperature	T <sub>NOM</sub>		25		°C		
Load Capacitance	CL		14.0		pF		
Frequency Tolerance	df/F	-30.0		+30.0	PPM	+25±3°C	
Frequency Temperature characteristics	df/F	-50.0		+50.0		-30~+75°C	
Frequency Ageing Rate		-1.0		+1.0		1 year	+25±3°C
Equivalent Series Resistance	ESR			65	Ω		
Drive Level	Pd	0.01		100	μW		
Insulation Resistance	IR	500			MΩ	100V(DC)	

**5. APPEARANCES, PHYSICAL DIMENSION**  
**OUTLINE DIMENSION (not to scale)**

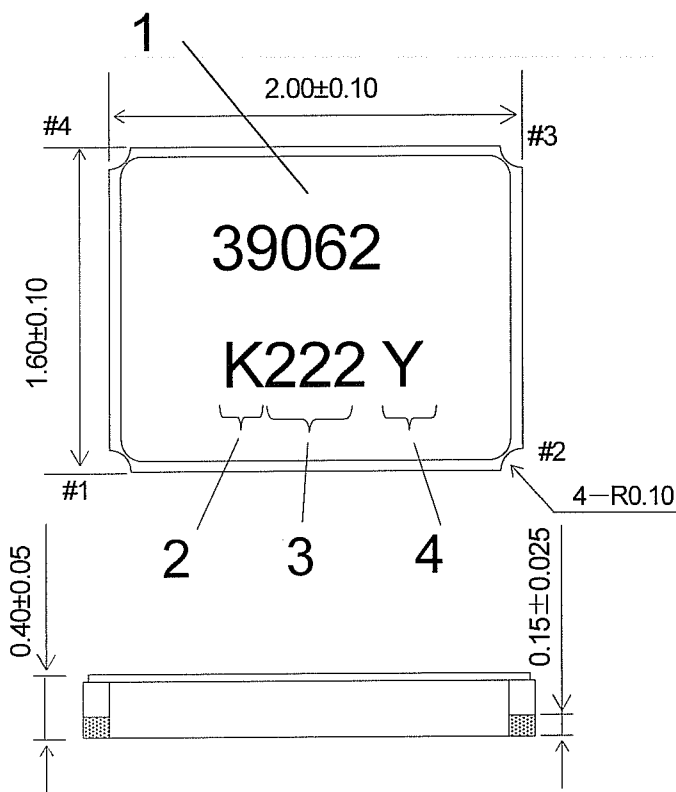

(TOP VIEW)

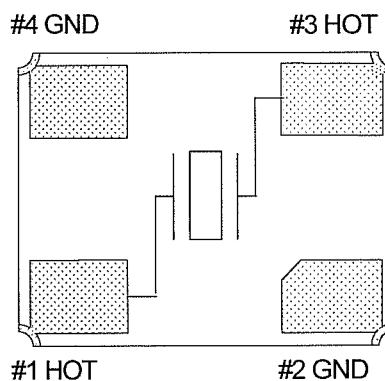

PIN NO.	PIN Layout
#1	HOT
#2	GND
#3	HOT
#4	GND

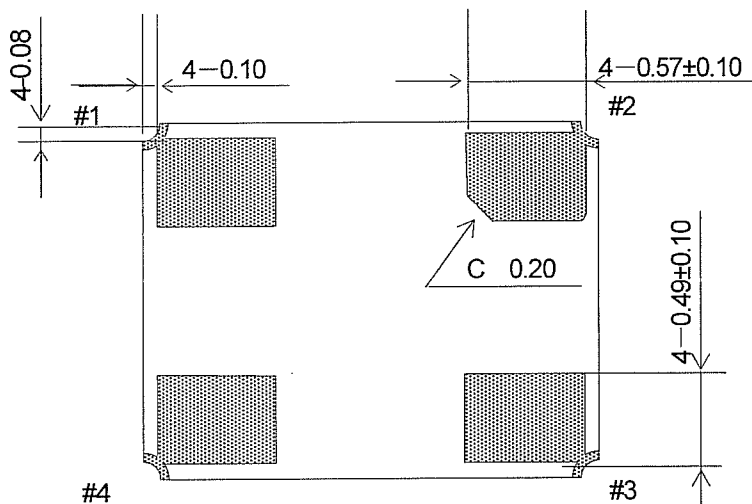

UNIT : mm

**MARKING**

- 1 Nominal Frequency Move the number of maximum indication beams of the frequency to five digits, and omit less than kHz.
- 2 Identification [K] mark is surely 1Pin direction.
- 3 Date Code Year ··LAST 1 DIGIT of YEAR AND WEEK  
(Ex)Jun, 01, 2012 → 222
- 4 Manufacturing Location  
Y··Yamagata  
Z··Shiga Yohkaichi

※The font of marking is reference.

KYOCERA Crystal Device Corporation

6. RECOMMENDED LAND PATTERN (not to scale)

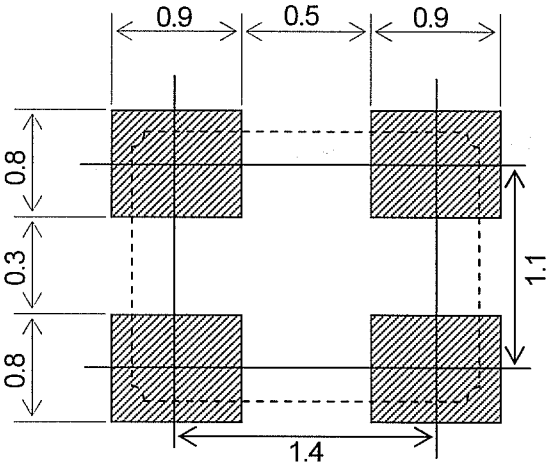

UNIT : mm

### 7.TAPING & REEL 荷姿

#### 7-1.Dimensions(寸法図)

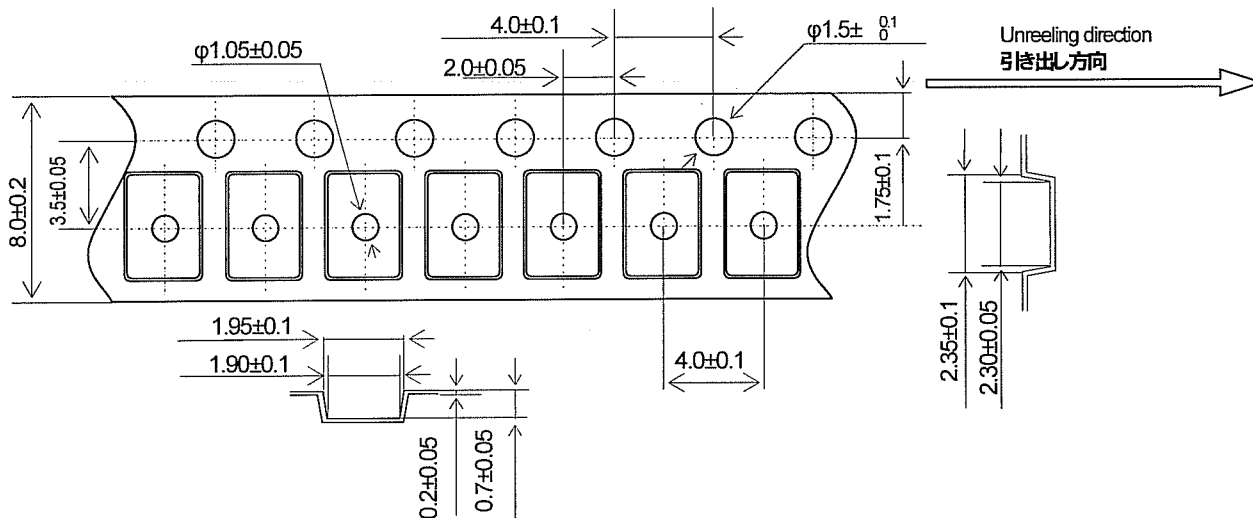

#### 7-2.Leader and trailer tape(リーダー部テープ部及び終末端部テープ)

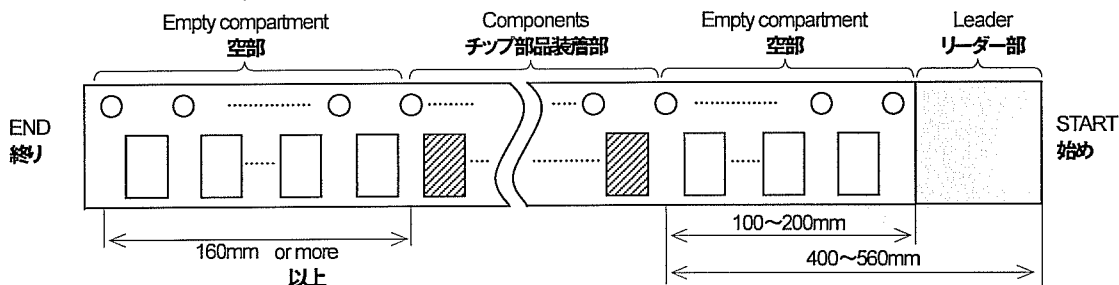

#### 7-3.Direction (The direction shall be seen from the top cover tape side)

テーピング方向  
(トップカバーテープ側から見る。)

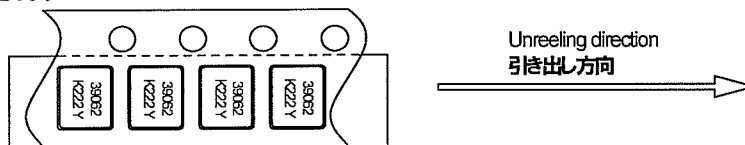

#### 7-4.Specification (記事)

- Material of the carrier tape shall be polystyrene or A-PET (ESD).  
(装着テープの材質は、PS もしくは A-PET とする。(静電対策品))
- Material of the seal tape shall be polyester(ESD). (シールテープの材質はポリエステルとする。(静電対策品))
- The seal tape shall not cover the sprocket holes. And not protrude from the carrier tape.  
(シールテープは送り穴をふさいだり、装着テープからはみ出していないこと。)
- Tensile strength of the tape: 10N or more. (テープの引張強度は 10N 以上)
- The R of the corner without designation is 0.2RMAX. (指定無きコーナーの R は 0.2RMAX)
- Disalignment between centers of the cavity and sprocket hole shall be 0.05mm or less.  
(角穴の中心と送り穴の中心とのずれは、0.05mm 以下とする。)
- Cumulative pitch tolerance of "P<sub>0</sub>" shall be ±0.2mm at 10 pitches. ("P<sub>0</sub>"の累積ピッチ許容差は、10ピッチで±0.2mmとする。)
- Suppose that it unifies as shown in the above-mentioned figure to the directivity of printing in an embossing tape.  
(エンボステープ内における印字の方向は上記図のように統一することとする。)
- Peeling force of the seal tape: 0.1 to 1.0N. (シールテープ剥離強度 0.1~1.0N)
- The component can fall headlong naturally from taping in the environment, such dry conditions, when this components were transferred to, cover was removed and the component was moved upside down.  
(カバーテープを外しテープを逆さにしたとき、輸送後及び乾燥等の環境下でも自重で部品が落下できる。)

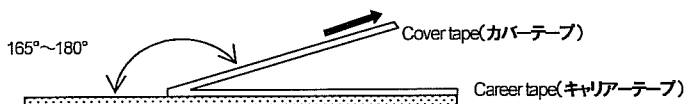

## Reel specifications リール

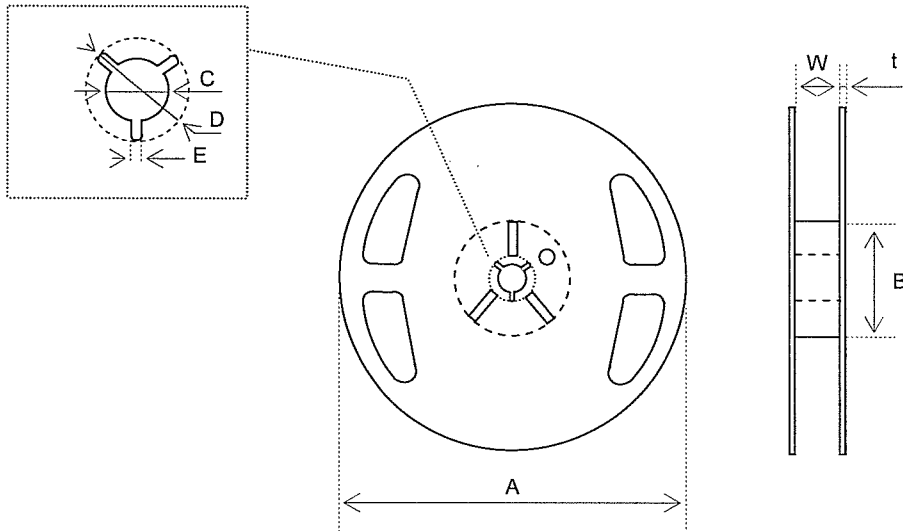

In the case of  $\Phi 180$  Reel (3000 pcs max, every 1,000 pcs)

Symbol	A	B	C	D
Dimension	$\phi 180 +0/-3$	$\phi 60 +1/-0$	$\phi 13 \pm 0.2$	$\phi 21 \pm 0.8$
Symbol	E	W	t	
Dimension	$2.0 \pm 0.5$	$9 \pm 1$	$2.0 \pm 0.5$	

(Unit : mm)

In the case of  $\Phi 330$  Reel (12,000 pcs max, every 1,000 pcs)

Symbol	A	B	C	D
Dimension	$\phi 330 \pm 0.2$	$\phi 100 \pm 1.0$	$\phi 13 \pm 0.2$	$\phi 21 \pm 0.8$
Symbol	E	W	t	
Dimension	$2.0 \pm 0.5$	$13.5 \pm 0.5$	$2.2 \pm 0.1$	

(Unit : mm)

## 8. Environmental requirements

After following test, frequency shall not change more than  $\pm 20 \times 10^{-6}$

And CI,  $\pm 20\%$  or  $5\Omega$  of large value.

### 8.1 Resistance to Shock

#### Test condition

Natural dropped from height 100cm onto hard wood board in 3 times

### 8.2 Resistance to Vibration

#### Test condition

frequency : 10 - 55 - 10 Hz  
 Amplitude : 1.5mm  
 Cycle time : 15 minutes  
 Direction : X,Y,Z (3direction), 2 h each.

### 8.3 Resistance to Heat

#### Test condition

The quartz crystal unit shall be stored at a temperature of  $+85 \pm 2^\circ\text{C}$  for 500 h.

Then it shall be subjected to standard atmospheric conditions for 1 h, after which measurement shall be made.

### 8.4 Resistance to Cold

#### Test condition

The quartz crystal unit shall be stored at a temperature of  $-40 \pm 2^\circ\text{C}$  for 500 h.

Then it shall be subjected to standard atmospheric conditions for 1 h, after which measurement shall be made.

### 8.5 Thermal Shock

#### Test condition

The quartz crystal unit shall be subjected to 500 successive change of temperature cycles, each as shown in table below, Then it shall be subjected to standard atmospheric conditions for 1h, after which measurements shall be made.

Cycle :  $-40 \pm 2^\circ\text{C}$  (30min.)  $\sim +25 \pm 2^\circ\text{C}$  (5min.)  
 $\sim +85 \pm 2^\circ\text{C}$  (30min.)  $\sim +25 \pm 2^\circ\text{C}$  (5min.)



8.6 Resistance to Moisture

Test condition

The quartz crystal unit shall be stored at a temperature of  $+60 \pm 2^\circ\text{C}$  with relative humidity of 90% to 95% for 240 h. Then it shall be subjected to standard atmospheric conditions for 1h, after which measurements shall be made

8.7 Soldering condition

1.) Material of solder

Kind ... lead free solder paste

Melting point ...  $+220 \pm 5^\circ\text{C}$

2.) Temp.profile of reflow soldering system

	Temp [ $^\circ\text{C}$ ]	Time[sec]
Peak	$+260 \pm 5$	10 (max.)
Preheating	$+180$ (typ.)	100 (typ.)
Total	—	200 (max.)

Frequency shift :  $\pm 2\text{ppm}$

3.) Hand Soldering Correspondence is impossible

4.) Reflow Tims 2 tims

Temp. profile of reflow

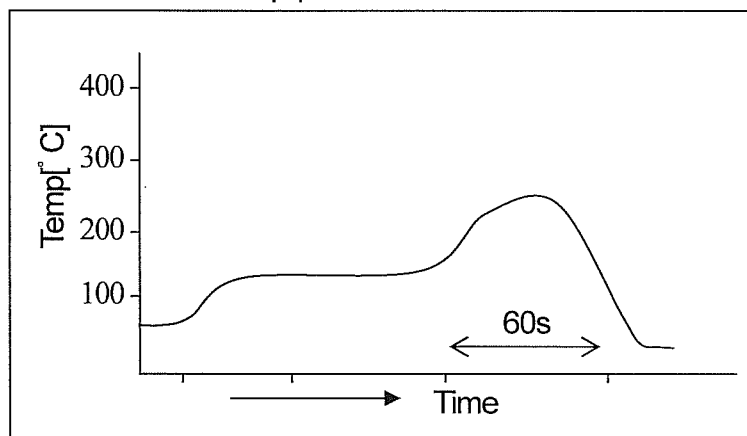

8.8 Intensity for bending in circuit board

Solder this product in center of the circuit board of  $40\text{mm} \times 100\text{mm}$ , and add the deflection of 3mm as the bottom figure.

Test board :  $t=1.6\text{mm}$

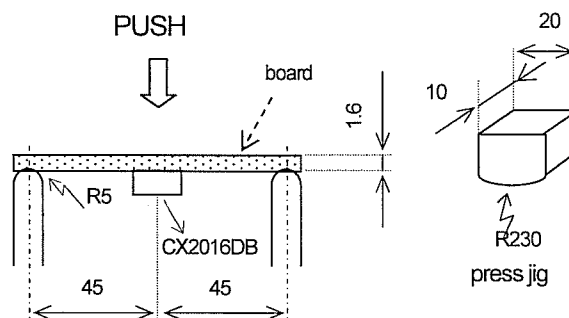

UNIT : mm

## 9. Cautions for use

### (1) Automatic mounting machine use

Please use after affirmation that select the mounting machine model with a shock small if possible in the case of use of an automatic mounting machine, and it does not have breakage. There is a risk of a crystal oscillating child's breakage occurring and not functioning normally by too much shock etc.

### (2) Conformity of a circuit

In case of use of an oscillation circuit, please insert in a crystal oscillating child in series resistance 5 time as many as the standard value of equivalent in-series resistance, and confirm oscillating. Please remove resistance which inserted after the notes above-mentioned examination in the crystal oscillating child in series, and use it.

## 10. Storage conditions

Storage at prolonged high temperature or low temperature and the storage by high humidity cause degradation of frequency accuracy, and degradation of soldering nature. Storage is performed at the temperature of +18~+30°C, and the humidity of 20-70 Percent in the state of packing, and a term is 6 months.

## 11. Quality Assurance

Location

Kyocera Crystal Device Yamagata Corporation ... Kyocera Crystal Device Yamagata  
Quality Assurance Division

Kyocera Crystal Device Corporation Shiga Yohkaichi Plant ... Kyocera Crystal Device  
Quality Assurance Division

## 12. Quality guarantee

When the failure by the responsibility of our company occurs clearly after delivery within 1 year, a substitute article etc. is appropriated gratuitously and this is guaranteed. However, when passing 1 year after delivery, there is a case where I am allowed to consider as onerous repair after both consultation.

## 13. Others

When any questions and opinions are in the written matter of these delivery specifications, I will ask connection of you from the company issue day within 45 days. In a connection no case, a written matter is consented to it and employed within a term.

## 14.LOT CALENDAR

WEEK 週	MONTH 月	MON 月	TUE 火	WED 水	THU 木	FRI 金	SAT 土	SUN 日	WEEK 週	MONTH 月	MON 月	TUE 火	WED 水	THU 木	FRI 金	SAT 土	SUN 日
152	1							1	227	7	2	3	4	5	6	7	8
201		2	3	4	5	6	7	8	228		9	10	11	12	13	14	15
202		9	10	11	12	13	14	15	229		16	17	18	19	20	21	22
203		16	17	18	19	20	21	22	230		23	24	25	26	27	28	29
204		23	24	25	26	27	28	29	231	8	30	31	1	2	3	4	5
205	2	30	31	1	2	3	4	5	232		6	7	8	9	10	11	12
206		6	7	8	9	10	11	12	233		13	14	15	16	17	18	19
207		13	14	15	16	17	18	19	234		20	21	22	23	24	25	26
208		20	21	22	23	24	25	26	235	9	27	28	29	30	31	1	2
209	3	27	28	29	1	2	3	4	236		3	4	5	6	7	8	9
210		5	6	7	8	9	10	11	237		10	11	12	13	14	15	16
211		12	13	14	15	16	17	18	238		17	18	19	20	21	22	23
212		19	20	21	22	23	24	25	239		24	25	26	27	28	29	30
213	4	26	27	28	29	30	31	1	240	10	1	2	3	4	5	6	7
214		2	3	4	5	6	7	8	241		8	9	10	11	12	13	14
215		9	10	11	12	13	14	15	242		15	16	17	18	19	20	21
216		16	17	18	19	20	21	22	243		22	23	24	25	26	27	28
217		23	24	25	26	27	28	29	244	11	29	30	31	1	2	3	4
218	5	30	1	2	3	4	5	6	245		5	6	7	8	9	10	11
219		7	8	9	10	11	12	13	246		12	13	14	15	16	17	18
220		14	15	16	17	18	19	20	247		19	20	21	22	23	24	25
221		21	22	23	24	25	26	27	248	12	26	27	28	29	30	1	2
222	6	28	29	30	31	1	2	3	249		3	4	5	6	7	8	9
223		4	5	6	7	8	9	10	250		10	11	12	13	14	15	16
224		11	12	13	14	15	16	17	251		17	18	19	20	21	22	23
225		18	19	20	21	22	23	24	252		24	25	26	27	28	29	30
226	7	25	26	27	28	29	30	1	253		31						