

Ground Master Monitor Installation, Operation and Maintenance



Figure 1. SCS 770060 Ground Master Monitor

Description

The SCS Ground Master Monitor is an equipment ground continuous monitor for metal tools. It continuously monitors the path-to-ground impedance and electromagnetic integrity of eight metal ground connections of process tools in work areas. This includes semiconductor, disk drive, flat panel, and electronic equipment manufacturing environments. The monitor provides both visual and audible alarms and includes fuse protection for each channel.

The Ground Master Monitor continuously monitors eight metal tools for electromagnetic interference (EMI). EMI can cause equipment lockups and malfunction. The Ground Master Monitor will alarm if EMI is detected. Each Ground Master Monitor is calibrated with accepted procedures and standards traceable to the National Institute of Standards and Technology (NIST) and includes a certificate of calibration.

The Ground Master Monitor meets the Continuous Monitor requirements of ANSI/ESD S20.20 in accordance with ESD TR1.0-01 and ANSI/ESD STM3.1. It meets the recommendations of ESD Handbook ESD TR20.20 which includes "if the products that are being produced are of such value that knowledge of a continuous, reliable ground is needed, and then continuous monitoring should be considered or even required".

The Ground Master Monitor and its accessories are available as the following item numbers:

Item	Description
770060	Ground Master Monitor
770064	Power Adapter, 100-240VAC Input, 7.5VDC 1.5A Output, All Plugs
CTC065-C	Ground Master Extension Cable Unit
CTE701	Workstation Monitor Checker
770055	SMP Software

SMP Static Management Program

The SCS 770060 Ground Master Monitor is compatible with SCS Static Management Program (SMP). SMP continuously monitors your ESD process control system throughout all stages of manufacturing. SMP captures data from SCS workstation, equipment and ESD event continuous monitors and provides a real-time picture of critical manufacturing processes. All activity is stored into a database for on-going quality control purposes. SMP allows you to pinpoint areas of concern and prevent ESD events. Quantifiable data allows you to see trends, become more proactive and prove the efficiency of your ESD process control system.

SMP is sold separately. [Click here](#) to learn more.

Packaging

- 1 Ground Master Monitor
- 1 Monitor Ground Cord (Green and Yellow)
- 4 Replacement Fuses (250 VAC, 125 mA)
- 1 Ring Terminal
- 1 Screw, Pan-Head, 6-32 x 1/4"
- 1 Star Washer
- 1 Power Adapter, 7.5VDC, with interchangeable plugs (North America, UK/Asia, Europe, China)
- 1 Certificate of Calibration

Features and Components

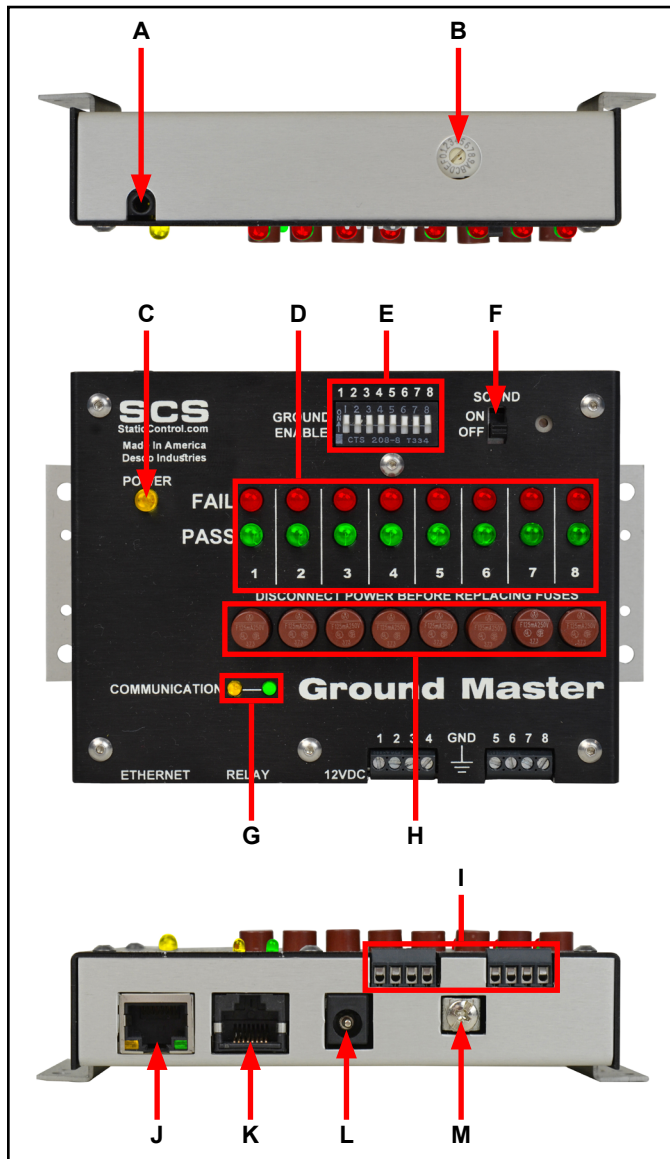

Figure 2. Ground Master Monitor features and components

A. Diagnostics Port: For manufacturer use only.

B. Test Limit Rotary Switch: Sets the test limit of the tool monitor circuits from 1 to 20 ohms.

Setting	Test Limit
1	1 ohm
2	2 ohms
3	3 ohms
4	4 ohms
5	5 ohms
6	6 ohms
7	7 ohms
8	8 ohms
9	9 ohms
A	10 ohms*
B	12 ohms
C	14 ohms
D	16 ohms
E	18 ohms
F	20 ohms

*default setting

C. Power LED: Illuminates yellow when the monitor is powered.

D. Tool LEDs: Illuminates green when its respective tool is within the impedance and electromagnetic interference (EMI) voltage test limits. Blinks red when its respective tool exceeds the EMI voltage limit. Illuminates solid red and audible alarm sounds when its respective tool exceeds the impedance test limit.

E. Tool Monitor Switches: Slide the switch up to enable its respective tool monitor circuit. Slide the switch down to disable its respective tool monitor circuit.

F. Audible Alarm Switch: Enables and disables the monitor's audible alarm.

G. Communication LEDs: Blinks when the monitor is powered and communicating to SMP Server.

H. Protective Fuses: Protects the spread of harmful voltage to other tools via the Ground Master Monitor should one of the tools become exposed to excessive voltage. The appropriate fuse will disconnect the faulty tool from the Ground Master Monitor and from the other connected tools.

I. Monitored Tool Terminals: Monitors metal tools for proper conductive impedance and electromagnetic interference (EMI) voltage. Use 18 AWG wire to connect the metal tools to these terminals.

J. Ethernet Jack: Provides network communication between the Ground Master Monitor and [Static Management Program \(SMP\)](#).

K. Relay Terminal: Integrates with electronic tools, lights, buzzers, etc.

L. Power Jack: Connect the included 7.5VDC power adapter here.

M. Ground Terminal: Common ground point for the monitor.

Installation

Hardware Setup

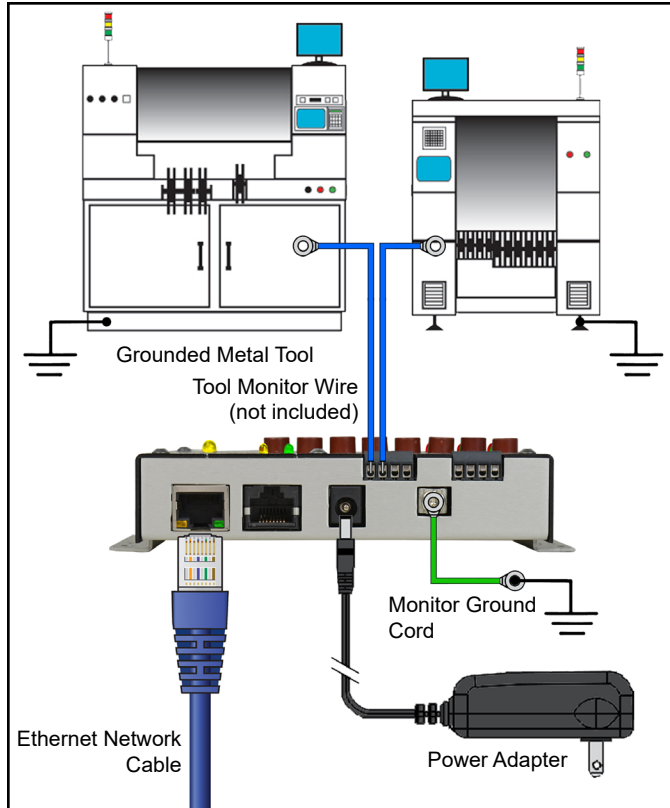

Figure 3. Wiring the Ground Master Monitor to two metal tools

1. Remove the Ground Master Monitor from the carton, and inspect for damage.
2. Determine the mounting location of the Ground Master Monitor, and use its mounting tabs to secure it. Its display should be visible to the operator(s).
3. Secure one end of the included ground cord to the ground terminal located on the bottom-side of the Ground Master Monitor. Attach the other end of the cord to a ground point. The face plate screw of a grounded AC wall outlet may provide a convenient connection point.
4. Insert stripped terminations of 18 AWG wires (not included) into the monitored tool terminals located on the bottom-side of the Ground Master Monitor. Ensure that the tool monitor switches are enabled if using these monitored tool terminals.

5. Route the tool monitor wires from the bottom-side of the Ground Master Monitor to their respective grounded metal tools, and secure them. Keep the wires as short as possible. Do not loop or coil them as it may affect the measured impedance.
6. Connect an Ethernet cable to the Ethernet jack located on the bottom-side of the Ground Master Monitor. Verify that the cable is properly connected to a network.
7. Connect the power adapter to the power jack located on the bottom-side of the Ground Master Monitor. Route the wire from the supply to a nearby AC outlet and plug it into the outlet. Make sure the voltage and frequency match those listed on the power supply. The Ground Master Monitor is now powered.

Relay Terminal

The Ground Master Monitor features one optical relay terminal that can be integrated with electronic tools, lights, buzzers, etc. The relay opens when the monitor enters a ground alarm condition, and it remains closed otherwise.

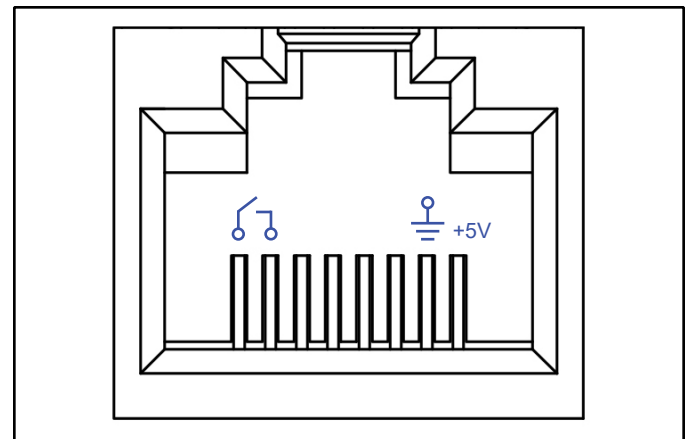

Figure 4. Relay terminal pin-out

Relay Parameter	Rating
Peak Blocking Voltage	400 V _P
Load Current	140 mA _{rms} / mA _{DC}
On-Resistance (max)	22 ohms

SMP Network Setup

The following procedure outlines how to connect the Ground Master Monitor to SMP via a local area network (LAN). SMP must be installed to a PC prior to using this procedure.

DYNAMIC IP PROCEDURE

1. Verify that the Ethernet cable is securely connected to your network and Ground Master Monitor. The LEDs on the Ethernet port will illuminate when a connection to the network is established.
2. Open SCS SMP Server Monitor.

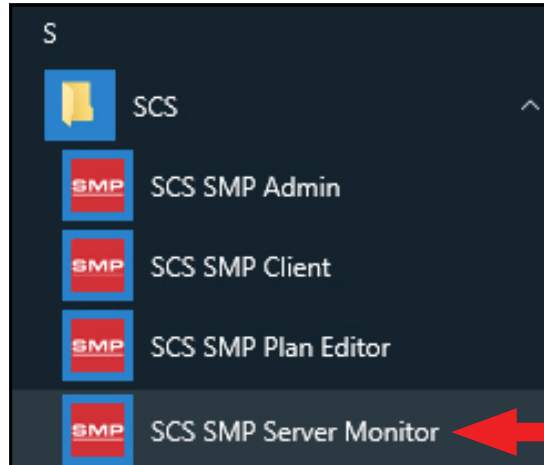

3. The SMP Server icon will appear in the Windows taskbar.

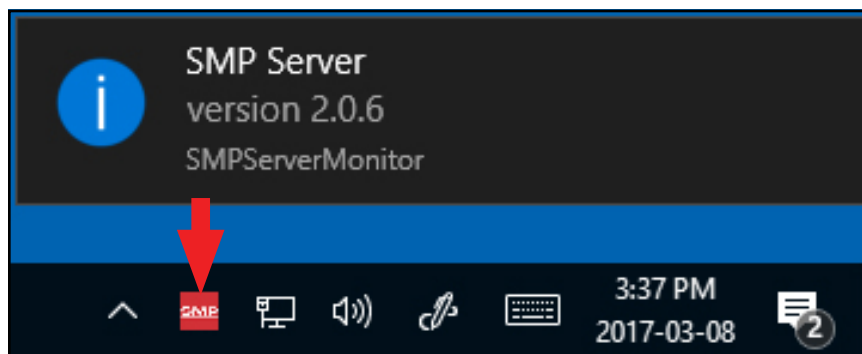

4. Click the SMP Server icon located on the Windows taskbar. The SMP Server menu will appear. Click the Start button to start SMP Server.

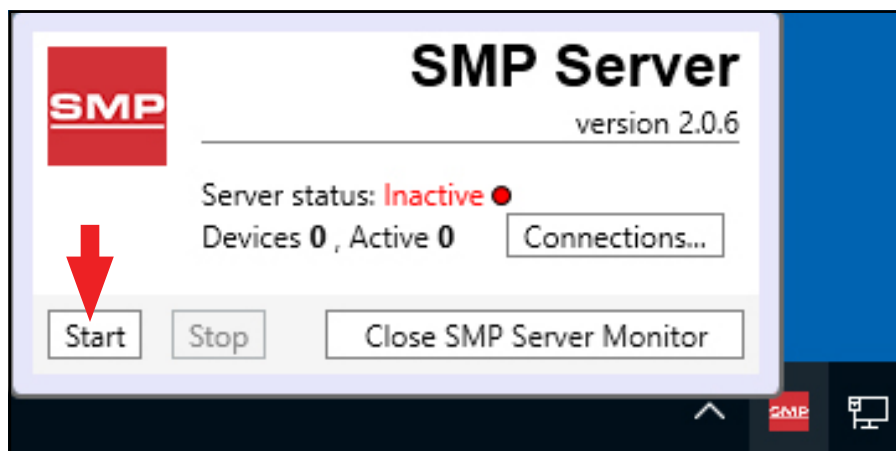

5. A message will appear and display “Starting SMP Server...” Click the SMP Server icon located in the Windows taskbar.

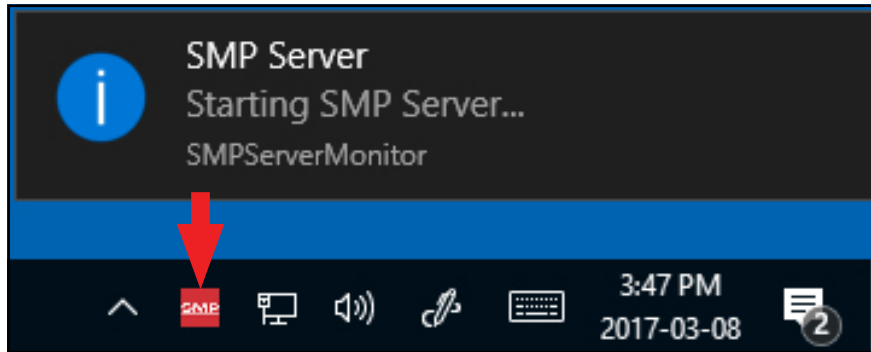

6. SMP Server will now indicate Active server status.

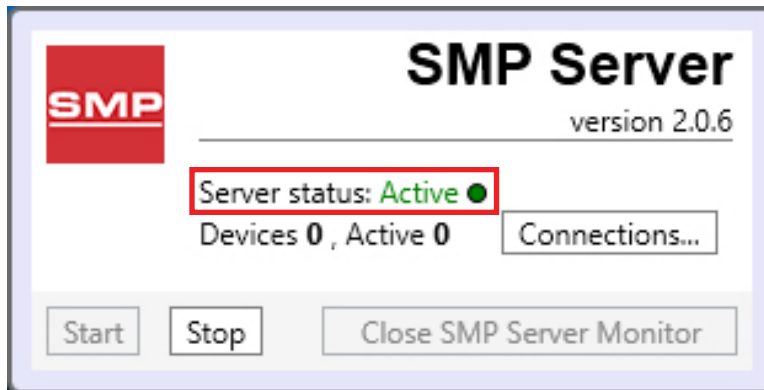

7. SMP Server will search and find the Ground Master Monitor on the network. The Device and Active counts will increase to 1.

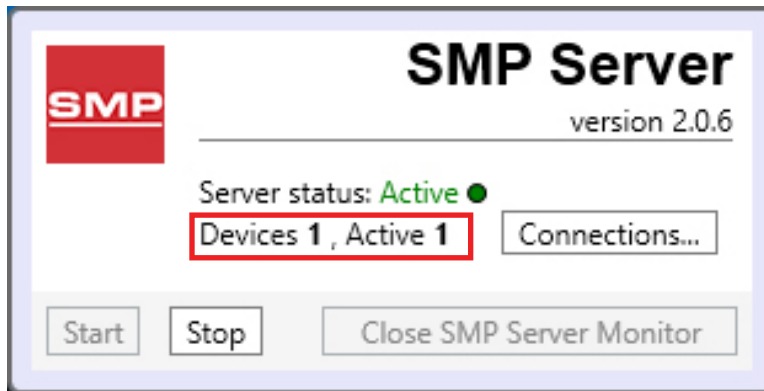

8. Open SCS SMP Admin.

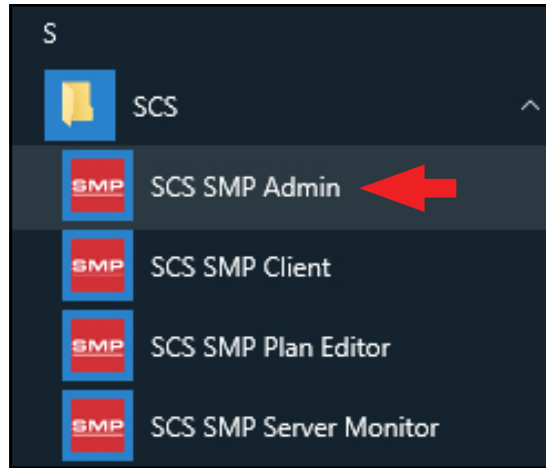

9. The window for SMP Server Admin will appear. "1 unassigned" is representative of the Ground Master Monitor that was just found by SMP Server. Click the Add New Building button.

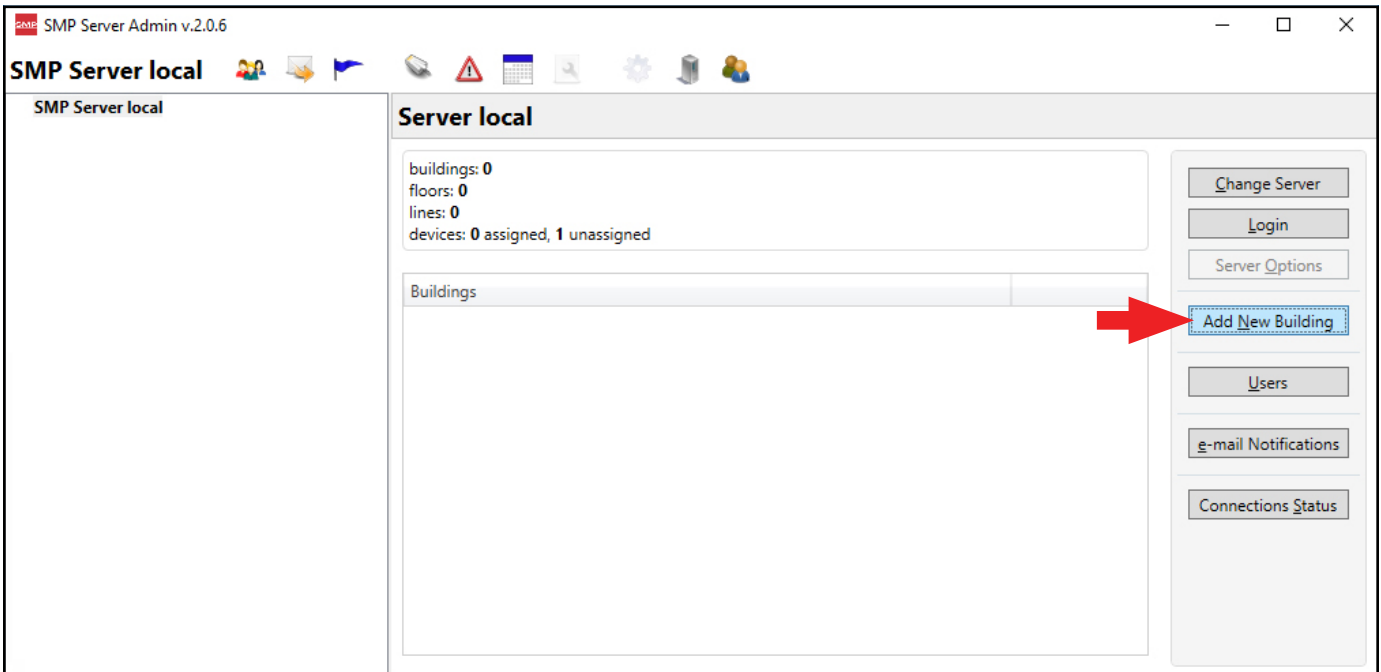

10. Enter a building name, and then click the OK button.

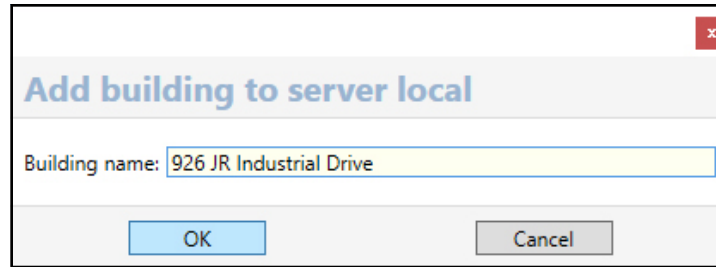

11. The building name will appear on the navigation pane in SMP Server Admin.

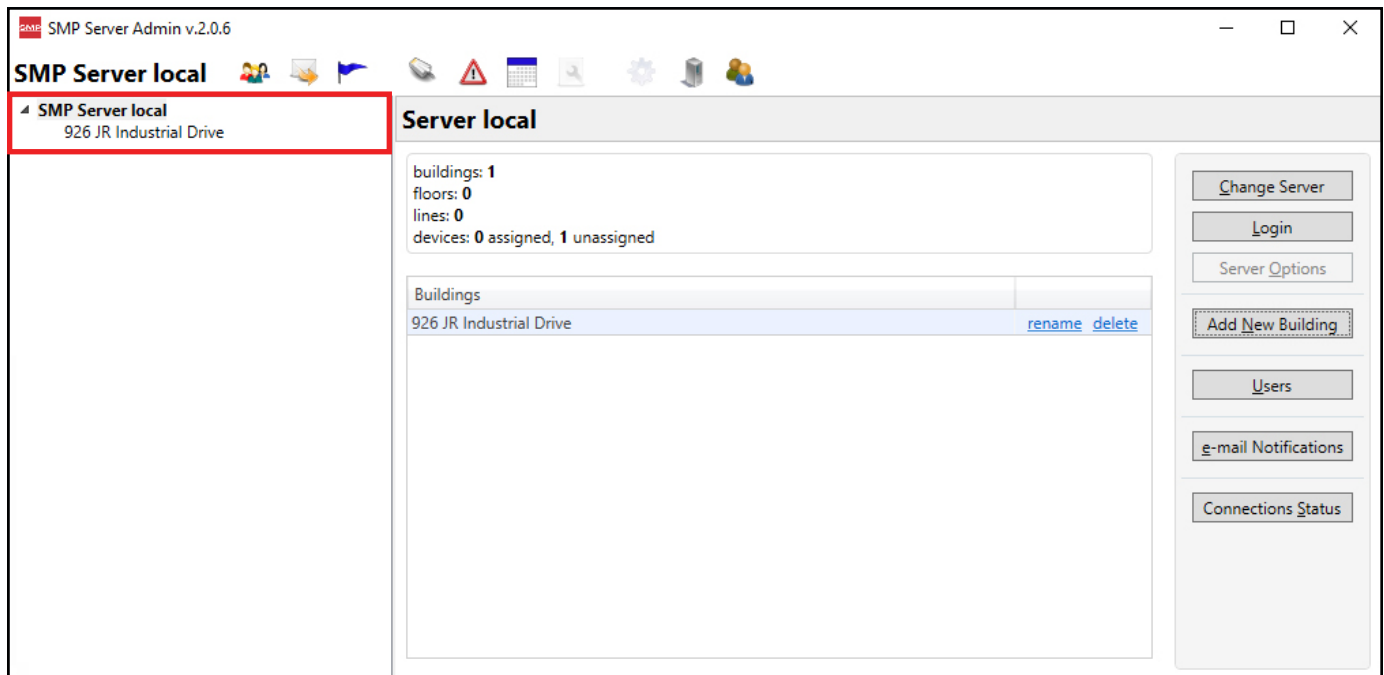

12. Click on the building name in the navigation pane, and then click the Add New Floor button.

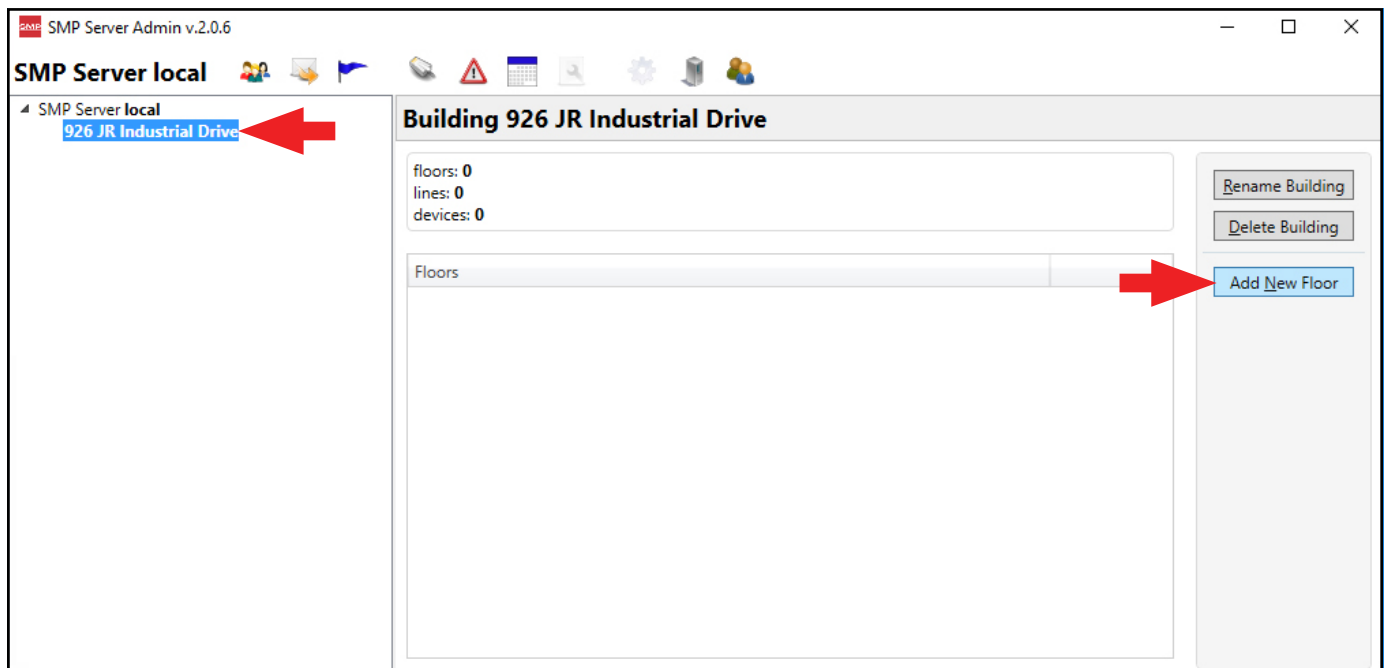

SCS - 926 JR Industrial Drive, Sanford, NC 27332
East: (919) 718-0000 | West: (909) 627-9634 • Website: StaticControl.com

13. Enter a floor name, and then click the OK button.

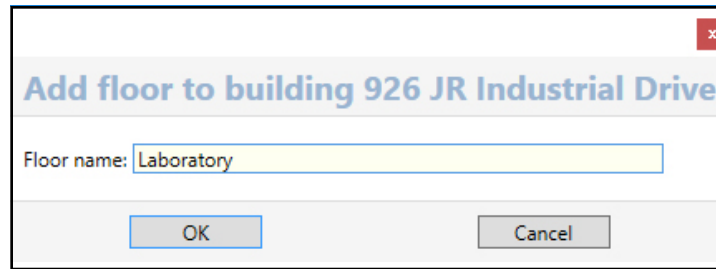

14. The floor name will appear on the navigation pane in SMP Server Admin.

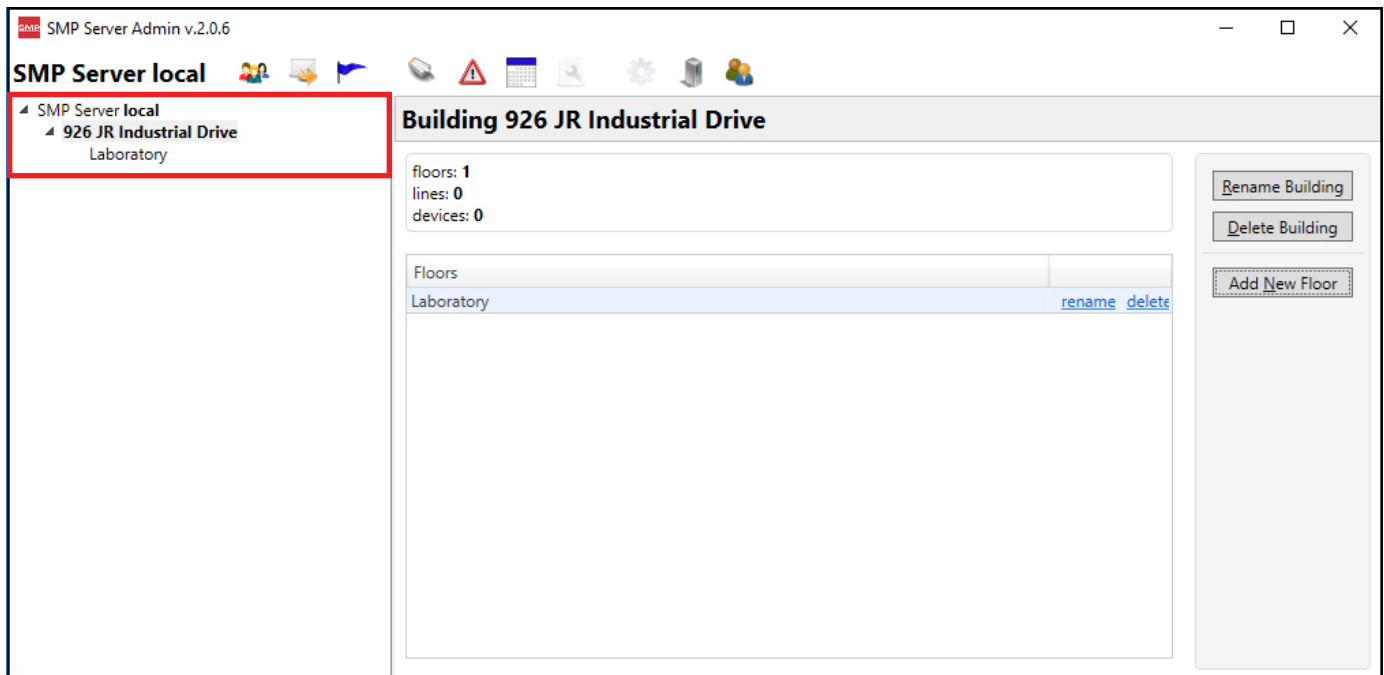

15. Click on the floor name in the navigation pane, and then click the Add New Line button.

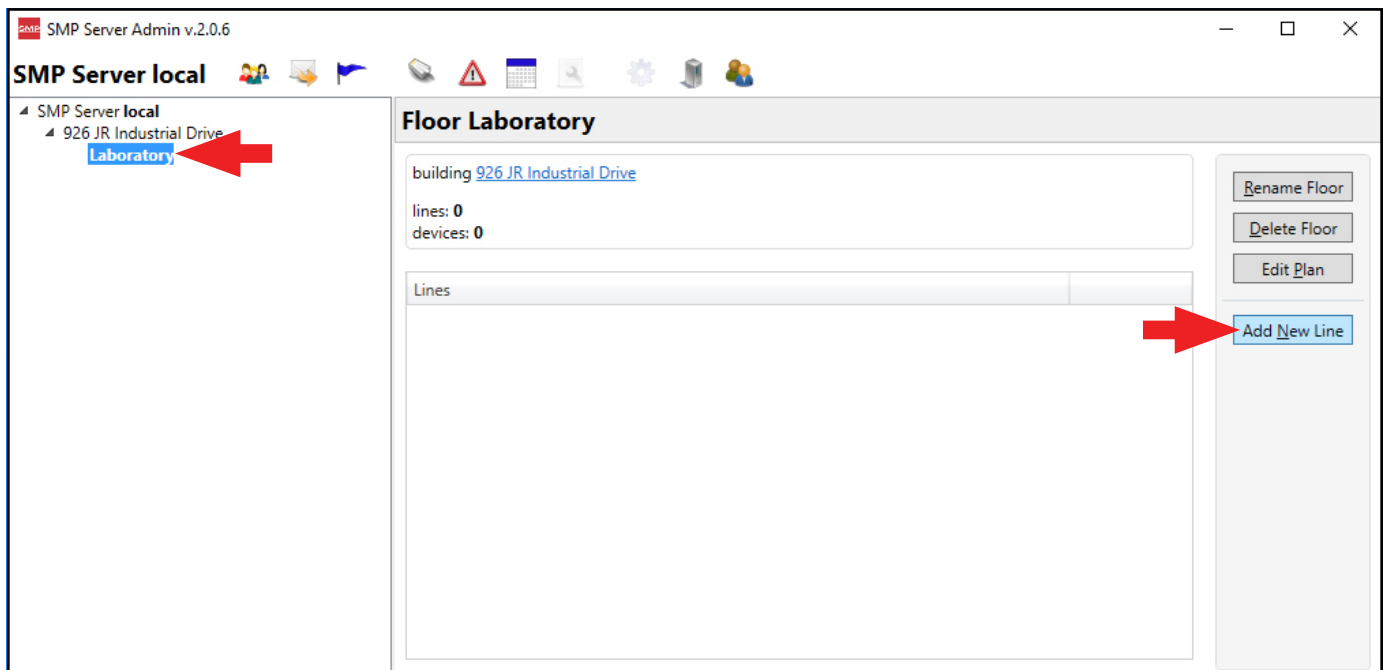

16. Enter a line name, and then click the OK button.

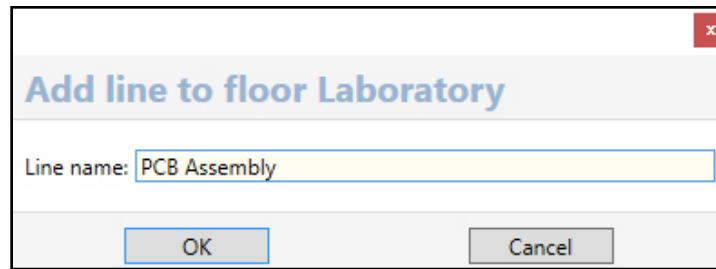

17. The line name will appear on the navigation pane in SMP Server Admin.

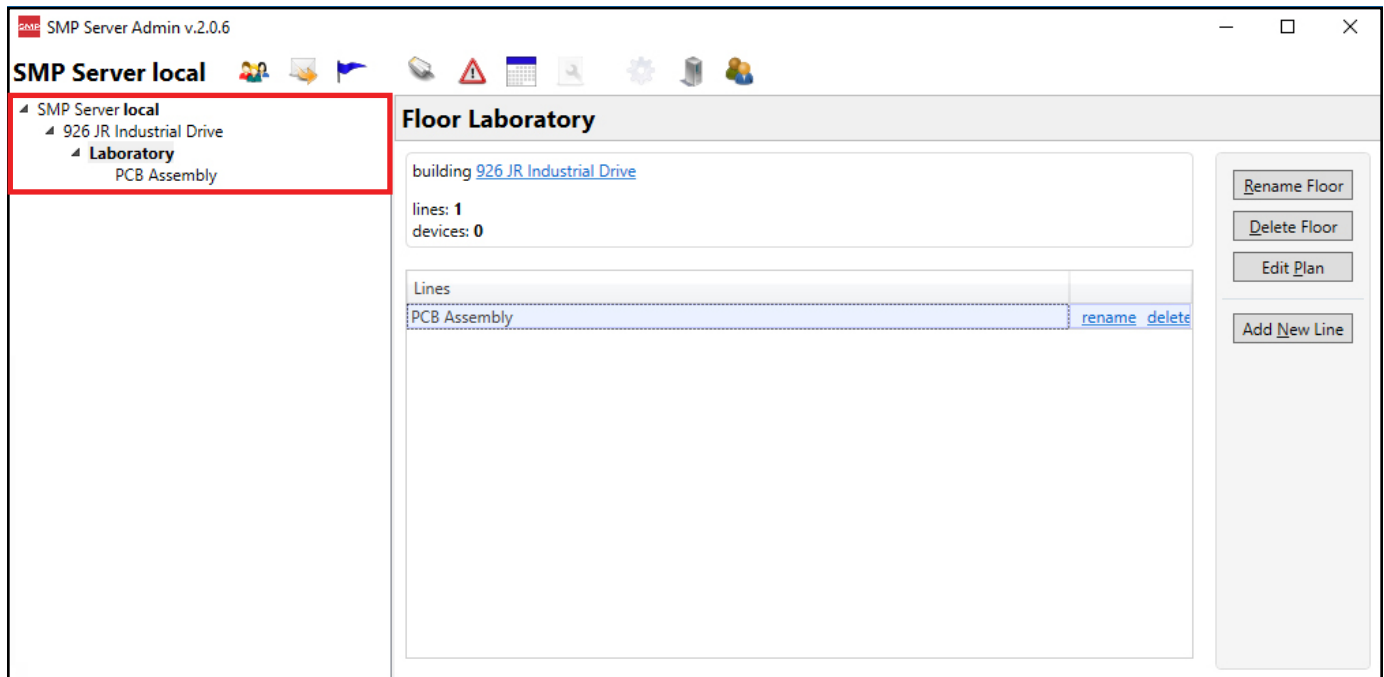

18. Click on the line name in the navigation pane, and then click the Attachable Devices arrow located at the bottom of the window.

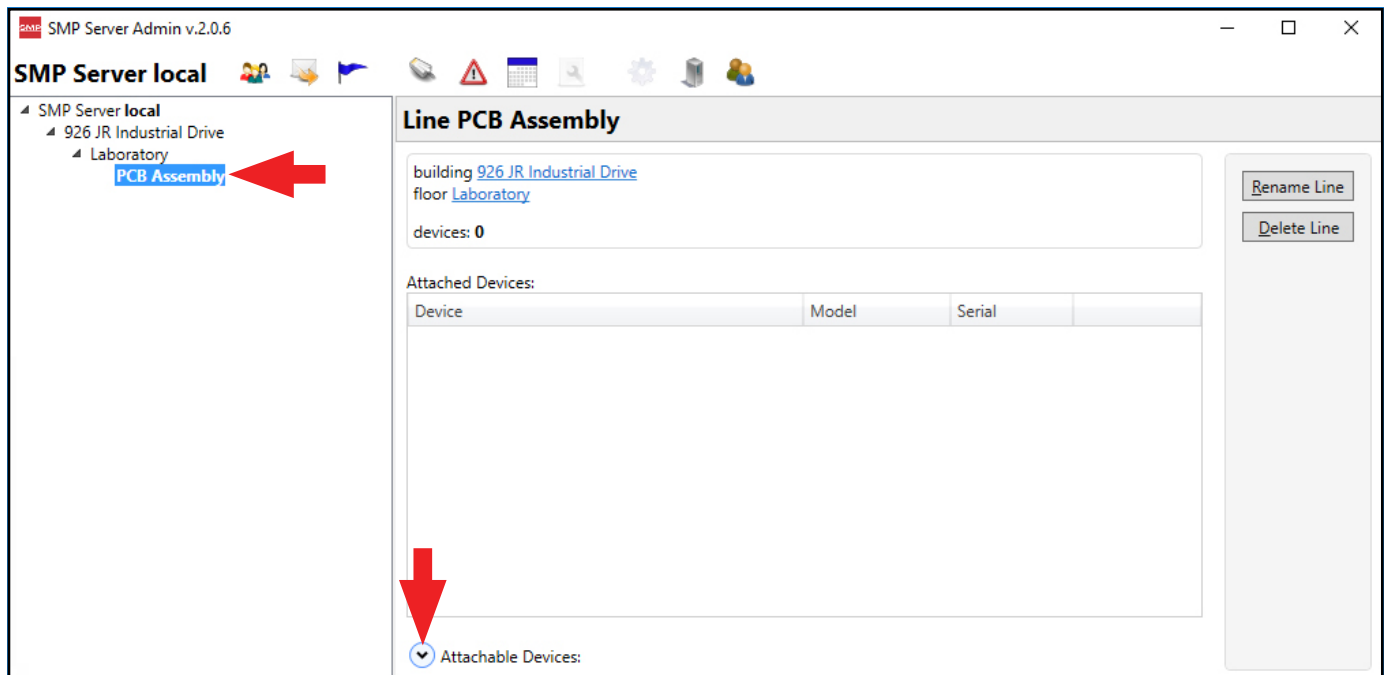

19. The serial number for the Ground Master Monitor will appear. Click attach.

SMP Server Admin v.2.0.6

SMP Server local

- SMP Server local
 - 926 JR Industrial Drive
 - Laboratory
 - PCB Assembly**

Line PCB Assembly

building [926 JR Industrial Drive](#)
floor [Laboratory](#)

devices: 0

Attached Devices:

Device	Model	Serial	
--------	-------	--------	--

Attachable Devices:

Name	Model	Serial	
[E91004000005]	Ground Master	E91004000005	attach

[Rename Line](#)
[Delete Line](#)

20. The Ground Master Monitor will attach to the selected line.

SMP Server Admin v.2.0.6

SMP Server local

- SMP Server local
 - 926 JR Industrial Drive
 - Laboratory
 - PCB Assembly**
[E91004000005]

Line PCB Assembly

building [926 JR Industrial Drive](#)
floor [Laboratory](#)

devices: 1

Attached Devices:

Device	Model	Serial	
[E91004000005]	Ground Master	E91004000005	rename detach

Attachable Devices:

Name	Model	Serial	
------	-------	--------	--

[Rename Line](#)
[Delete Line](#)

21. Open SCS SMP Client.

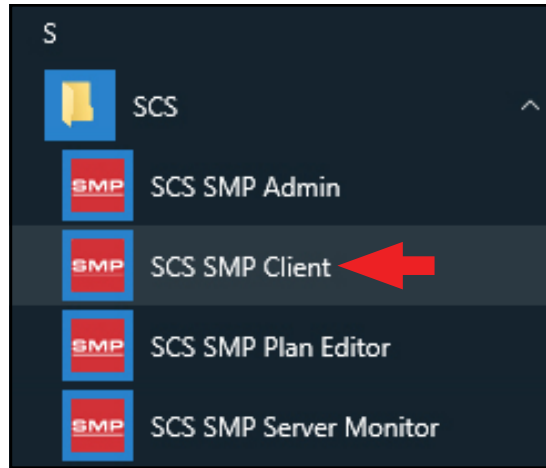

22. Verify that the Ground Master Monitor was added to the appropriate building, floor and line.

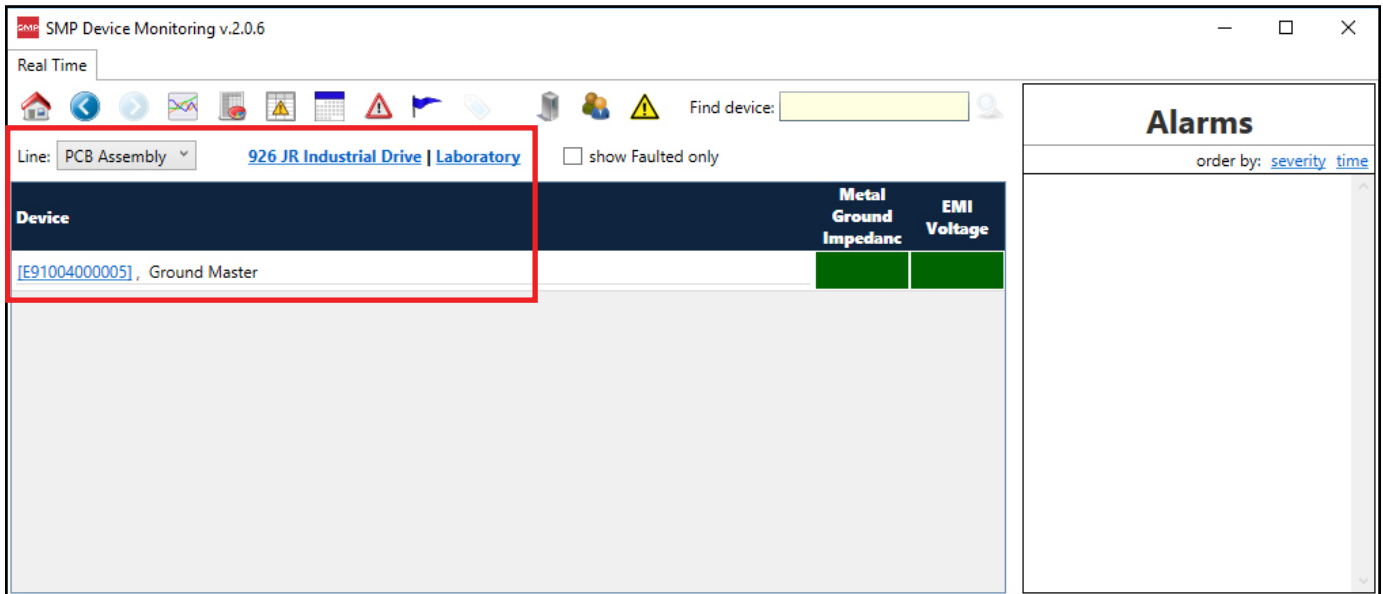

Operation

Use the table below to interpret the behavior of the Ground Master Monitor's tool LED's and audible buzzer (if enabled).

Green LED	Red LED	Buzzer	Status
ON	OFF	OFF	No failures
OFF	ON	ON	Impedance failure
ON	BLINK	OFF	EMI voltage failure
OFF	OFF	OFF	Monitor channel disabled

Maintenance

Cleaning

Disconnect the power adapter from the device. Clean the Ground Master Monitor using a dry brush or vacuum cleaner. Clean its contacts using a contact cleaner or brush, and tighten all connections. Do not reconnect the power adapter until cleaning is finished.

Replacing the Fuses

The monitored equipment may become prone to excessive voltage and significant damage should it lose its connection to ground or be bonded to an improperly wired ground point. In order to prevent the spread of this excessive voltage to other equipment via the Ground Master Monitor, fuses are implemented for each individual ground connection. In the case of excessive voltage on the equipment, the appropriate fuse will disconnect the equipment from the Ground Master Monitor and from the other connected equipment. Ground failure on that particular ground will be immediately indicated.

Before replacing the fuse, always investigate the reason for the fuse blowing, and correct the problem. The fuse should never blow under normal circumstances.

NOTE: Never use wire jumpers in place of fuses. Use only factory-authorized fuses. Disconnect power before replacing any fuses.

Calibration

Frequency of recalibration should be based on the critical nature of those ESD sensitive items handled and the risk of failure for the ESD protective equipment and materials. In general, SCS recommends that calibration be performed annually.

Use the SCS CTE701 Workstation Monitor Checker to perform periodic verification (once every 6-12 months) of the Ground Master Monitor. The Workstation Monitor Checker can be used to check the test limits of the Ground Master Monitor without removing it from the factory floor.

See [TB-9031](#) for more information.



Figure 10. SCS CTE701 Workstation Monitor Checker

Specifications

Power

Power Adapter	Output: 7.5VDC @ 1.5A
100-240VAC	Output Plug Polarization: Center Positive
50-60 Hz	Output Plug: 5.5 mm O.D. x 2.1 mm I.D. x 9.5 mm L

Metal Tool

Amount Monitored	8
Impedance Limit	10 ohms (default)
EMI Voltage Limit	223 mV

Connectivity

Input	18 AWG wire terminal blocks for metal tools
Outputs	RJ45 connectors for Ethernet and relay outputs

General

Alarm	LEDs and buzzer
Dimensions	3.54" x 5.52" x 1.18" (90 mm x 140 mm x 30 mm)
Weight	0.4 lbs. (0.18 kg)

Safety Information

Please read, understand, and follow all safety information contained in these instructions prior to the use of this device. Retain these instructions for future reference.

Intended Use

The SCS Ground Master Monitor is an equipment ground continuous monitor for metal tools. It continuously monitors the path-to-ground and electromagnetic integrities of eight metal ground connections of process tools in work areas. This includes semiconductor, disk drive, flat panel, and electronic equipment manufacturing environments. The monitor provides both visual and audible alarms and includes fuse protection for each channel.

The systems must be installed as specified in this user guide in an indoor commercial/industrial environment, and have not been evaluated for other uses or locations. If the equipment is used in a manner not specified by the manufacturer, the protection provided by the equipment may be impaired.

Warning

To reduce the risks associated with hazardous voltage and fire:

- Do not use the power supply if damaged
- Replace power supply if damaged using only SCS supplied parts.
- Do not modify or attempt to service the power supply. Return to SCS for service.
- Do not use the Ground Master Monitor or its power supply outdoors or in wet/humid environments.
- Do not use the Ground Master Monitor or its power supply outside of the operating conditions listed in this User Guide.
- Use only a dry cloth when cleaning.

To reduce the risks associated with hazardous voltage:

- Use only the power supply provided by SCS and specified for the country of use.
- Do not simultaneously power the Ground Master Monitor with the power supply and the RJ45 data cable.
- Do not position the monitor accessories or other equipment where unplugging the power supply is difficult.
- Always locate the power source (socket or outlet) near the equipment. The power supply plug serves as the disconnect device.

Caution

To reduce the risks associated with environmental contamination:

- Dispose of monitor and power supply in accordance with all applicable local and government regulations.

Notice

To reduce the risk of damage to components or assemblies being handled:

- Monitor must be checked periodically to verify each test mode is functioning correctly.
- Ensure proper operation of the monitor by performing operational verification test as required.
- Always properly ground your tools and dissipative surfaces to before connecting them to the Ground Master Monitor.

FCC

This equipment has been tested and found to comply with the limits for a Class A digital device, pursuant to Part 15 of the FCC Rules. These limits are designed to provide reasonable protection against harmful interference when the equipment is operated in a commercial environment. This equipment generates, uses, and can radiate radio frequency energy and, if not installed and used in accordance with the instruction manual, may cause harmful interference to radio communications. Operation of this equipment in a residential area is likely to cause harmful interference in which case the user will be required to correct the interference at his own expense.

Industry Canada ICES-003 Compliance:
CAN ICES-3 (A)/NMB-3(A)

Environmental Conditions

This equipment has been tested and found to be safe to operate within these environmental conditions.

This is not a warranty of equipment performance within these conditions.

- Indoor use only
- Ingress Protection: IPX0
- Altitude: Up to 2,000 m
- Mains supply voltage fluctuations up to $\pm 10\%$ of the nominal voltage.
- Transient over-voltages up to the levels of overvoltage category II.
- Temporary over-voltages occurring on mains supply.
- Pollution degree 2.
- Temperature: Maximum 110°F / 43°C, Minimum 50°F / 10°C
- Humidity: Maximum relative humidity 80% for temperatures up to 31°C decreasing linearly to 50% relative humidity at 40°C.

Regulatory Information

China RoHS

Electronic Industry Standard of the People’s Republic of China, SJ T11363-2006, Requirements for Concentration Limits for Certain Hazardous Substances in Electronic Information Products



This symbol, per Marking for the Control of Pollution Caused by Electronic Information Products, SJ/T11364-2006, means that the product or part does contain a substance, as detailed in the chart below, in excess of the following maximum concentration values in any homogeneous material: (a) 0.1% (by weight) for lead, mercury, hexavalent chromium, polybrominated biphenyls or polybrominated diphenyl ethers; or (b) 0.01% (by weight) for cadmium. Unless otherwise stated by SCS in writing, this information represents our best knowledge and belief based upon information provided by third party suppliers to SCS.

Part or Component Name	Hazardous Substances or Elements					
	(Pb)	(Hg)	(Cd)	(CrVI)	(PBB)	(PBDE)
Solder in instrument	X	O	O	O	O	O

O: Indicates that this hazardous substance contained in all of the homogeneous materials for this part is below the limit requirement in the SJ/T11363-2006.
 X: Indicates that this hazardous substance contained in at least one of the homogeneous materials used for this part is above the limit requirement in the SJ/T11363-2006.

Limited Warranty, Warranty Exclusions, Limit of Liability and RMA Request Instructions

See the SCS Warranty - <http://staticcontrol.descoindustries.com/Limited-Warranty.aspx>