

LT1676/LT1776 High Voltage High Efficiency Step-Down DC/DC Converters

DESCRIPTION

Demonstration circuit DC204 Version A is a high efficiency step-down (buck) regulator using the LT1676 switching regulator. Typical applications include automotive DC/DC conversion, telecom 48V step-down and IEEE1394 step-down converters. This controller includes an onboard 700mA peak-current switch and is optimized for use with a high supply voltage. The input voltage can range from 7V to 60V. The output voltage is jumper selectable to either 3.3V or 5V. The LT1676 uses a 100kHz switching frequency and current mode control, resulting in very high efficiency, low ripple and fast transient response. At low output currents, the LT1676 automatically slows down the

turn-on rise time. This eliminates pulse skipping, which helps reduce output ripple voltage and switching noise in the audio frequency spectrum. Additionally, the supply current can be shut down to less than 20µA in standby mode. Demonstration circuit DC204 Version B is also a high efficiency step-down regulator using the LT1776 switching regulator. The LT1776 is identical to the LT1676 with the exception that its nominal operating frequency is 200kHz. **Gerber files for this circuit board are available. Call the LTC factory.**

 LTC and LT are registered trademarks of Linear Technology Corporation.

PERFORMANCE SUMMARY $T_A = 25^\circ\text{C}$

SYMBOL	PARAMTER	CONDITIONS	JUMPER POSITION		VALUE
V_{IN}	Input Voltage Range	Version A (LT1676) Version B (LT1776)			7V to 60V 7V to 60V
V_{OUT}	Output Voltage (Jumper Selectable)	See Figure 1	J1	Closed	5V
			J1	Open	3.3V
I_O	Maximum Output Load Current	$V_{IN} > 12V$			500mA
		$V_{IN} \leq 12V, V_{OUT} = 5V$	J1	Closed	450mA
V_{RIP}	Typical Output Ripple	$I_O = 500mA$			16mV _{p-p}
f_O	Nominal Operating Frequency	Version A (LT1676) Version B (LT1776)			100kHz 200kHz
I_Q	Supply Current in Shutdown				20µA

TYPICAL PERFORMANCE CHARACTERISTICS AND BOARD PHOTO

LT1676 Output Efficiency
 $V_{IN} = 40V, V_{OUT} = 5V$

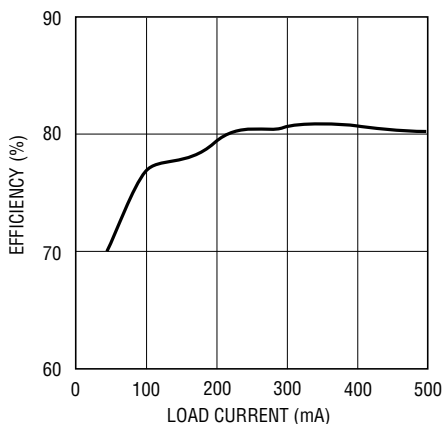

DC204 F00

Component Side



DC204 BP

DEMO MANUAL DC204

NO-DESIGN SWITCHER

PACKAGE A ID SCHEMATIC DIAGRAMS

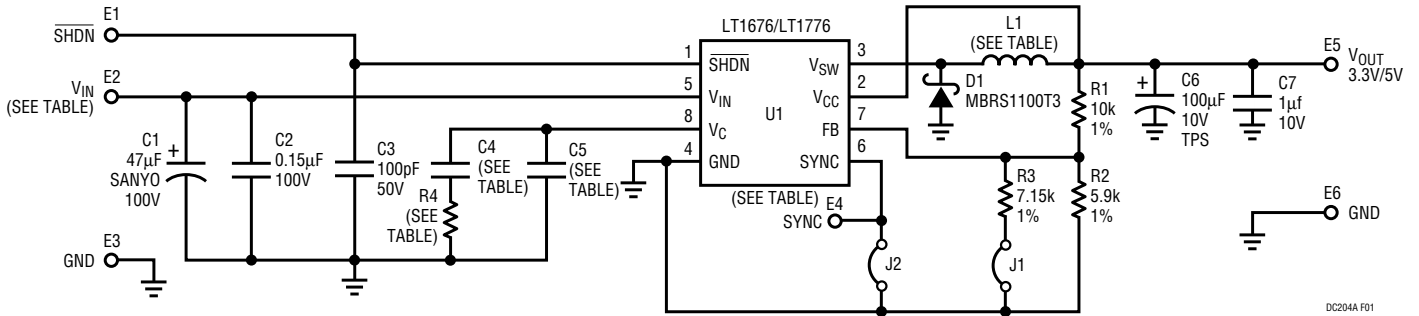

DC204A F01

ASSEMBLY	V _{IN}	U1	C4	C5	L1	R4
VERSION A	7V TO 60V	LT1676CS8	1000pF	100pF	CTX200-4	47k
VERSION B	7V TO 60V	LT1776CS8	180pF	39pF	CTX100-2	100k

OUTPUT VOLTAGE SELECT		
J1	CLOSED	5V
J1	OPEN	3.3V

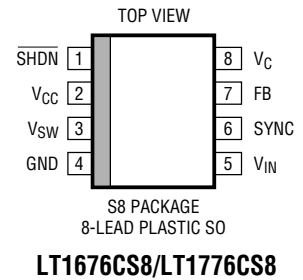

Figure 1. LT1676/LT1776 High Efficiency Step-Down DC/DC Converter Schematic

PARTS LIST

REFERENCE DESIGNATOR	QUANTITY	PART NUMBER	DESCRIPTION	VENDOR	TELEPHONE
C1	1	100MV47GX	47µF 100V TPS Tantalum Capacitor	SANYO	(619) 661-6835
C2	1	VJ1210Y154KXBAT	0.15µF 100V X7R Chip Capacitor	Vitramon	(203) 268-6261
C3	1	08055A101KAT	100pF 50V NPO Chip Capacitor	AVX	(803) 946-0362
C4	1	08055C102KAT	1000pF 50V X7R Chip Capacitor (Version A)	AVX	(803) 946-0362
	1	08055C181KAT	180pF 50V Chip Capacitor (Version B)	AVX	(803) 946-0362
C5	1	08055A101KAT	100pF 50V NPO Chip Capacitor (Version A)	AVX	(803) 946-0362
	1	08055A390KAT	39pF 50V Chip Capacitor (Version B)	AVX	(803) 946-0362
C6	1	TPSD107M010R0080	100µF 10V TPS Tantalum Capacitor	AVX	(207) 282-5111
C7	1	0805ZC105KAT2A	1µF 10V X7R Chip Capacitor	AVX	(803) 946-0362
D1	1	MBRS1100T3	1A 100V Schottky Diode	Motorola	(800) 441-2447
E1 to E6	6	2501-2	Testpoint Turret	Mill-Max	(516) 922-6000
J1, J2	2	2802S-02-G2	0.079" 2X1 Header	Comm Con	(626) 301-4200
P1, P2	2	CCIJ2MM-138-G	0.079" Center Shunt	Comm Con	(626) 301-4200
L1	1	CTX200-4	200µH Inductor (Version A)	Coiltronics	(561) 241-7876
	1	CTX100-2	100µH Inductor (Version B)	Coiltronics	(561) 241-7876
R1	1	CR10-1002FM	10k 1/8W 1% Chip Resistor	TAD	(714) 255-9123
R2	1	CR10-5901FM	5.9k 1/8W 1% Chip Resistor	TAD	(714) 255-9123
R3	1	CR10-7151FM	7.15k 1/8W 1% Chip Resistor	TAD	(714) 255-9123
R4	1	CR10-473JM	47k 1/8W 5% Chip Resistor (Version A)	TAD	(714) 255-9123
	1	CR10-104JM	100k 1/8W 5% Chip Resistor (Version B)	TAD	(714) 255-9123
U1	1	LT1676CS8	IC, SO8 (Version A)	LTC	(408) 432-1900
	1	LT1776CS8	IC, SO8 (Version B)	LTC	(408) 432-1900

QUICK START GUIDE

Refer to Figure 2 for proper measurement equipment setup and follow the procedure outlined below:

1. Connect the input power supply to the V_{IN} and GND terminals. The input voltage must be between 7V and 60V.
2. Connect an ammeter in series with the input supply to measure input current.
3. Connect either power resistors or an electronic load to the V_{OUT} and GND terminals.
4. Connect an ammeter in series with output load to measure output current.
5. The \overline{SHDN} pin should be left floating for normal operation and tied to GND for shutdown.
6. Leave jumper J2 connected to operate the LT1676 (Version A) at its nominal switching frequency of 100kHz or the LT1776 (Version B) at 200kHz.
7. Set the output voltage with jumper J1, as shown in the table below.
8. After all connections are made, turn on input power and verify that the output voltage is correct.

POSITION	OUTPUT VOLTAGE
Jumper J1 Closed	5V
Jumper J1 Open	3.3V

OPERATION

Introduction

The circuit in Figure 1 highlights the capabilities of the LT1676/LT1776. The application circuit is set up for an output voltage of either 3.3V or 5V by means of jumper J1. The demo board comes equipped with input, output, GND, SYNC and SHDN terminals to make bench testing convenient.

Since the LT1676/LT1776 demo board allows such a wide input range, it uses two techniques to optimize efficiency. First, the internal control circuitry draws power from the V_{CC} pin, which is normally connected to the output supply. During start-up, the LT1676/LT1776 draw power from V_{IN} . After the switching supply output voltage reaches 2.9V, the LT1676/LT1776 draw power from the output. This reduces quiescent power consumption by hundreds of milliwatts when operating at a high input voltage. Second, the LT1676/LT1776 switch circuitry maintains a fast rise time at high loads. Both of these factors help in maximizing efficiency with high loads and high line voltages. At light loads, the LT1676/LT1776 slow down the rise time to avoid pulse skipping, maintaining a constant frequency at all loads. This helps significantly in reducing output ripple voltage and prevents switching noise from folding back into the audio frequency spectrum.

Theory of Operation

During normal operation, the internal power transistor is turned on during each cycle when the oscillator sets a latch and turned off when the main current comparator resets the latch. While the internal switch is off, the Schottky diode (D1) carries the inductor current until it tries to reverse or until the beginning of the next cycle. The voltage on the V_C pin, which is the output of the error amplifier, controls the peak inductor current. The FB pin provides the error amplifier with an output feedback voltage, V_{FB} , from an external resistor divider. When the load current increases, it causes a slight decrease in V_{FB} relative to the 1.24V reference, which, in turn, causes the voltage on the V_C pin to increase until the average inductor current matches the new load current.

SYNC Pin

This pin is used to synchronize the internal oscillator to an external clock with a frequency between 130kHz and 250kHz for the LT1676 and between 250kHz and 400kHz for the LT1776. If a switching frequency higher than nominal is desired, remove jumper J2 and tie an external oscillator of the desired frequency between the SYNC terminal and the input GND terminal. The amplitude of the

OPERATION

external oscillator can be a TTL compatible level or 3.3V logic levels, with a duty cycle between 10% and 90%. Refer to the “Selecting Power Inductor” section in the LT1676/LT1776 data sheet for how to optimize the inductor value if running at a higher frequency.

How to Measure Voltage Regulation and Efficiency

When measuring load regulation or efficiency, voltage measurements should be made directly across the V_{OUT} and GND terminals, not at the end of test leads at the load. Similarly, input voltage should be measured directly at the V_{IN} and GND terminals of the LT1676/LT1776 demo board. Input and output current should be measured by placing an ammeter in series with the input supply and load. Refer to Figure 2 for the proper monitoring equipment setup.

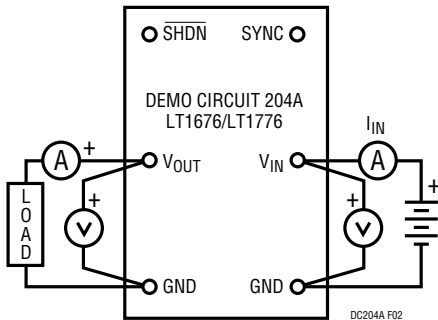

Figure 2. Proper Measurement Setup

How to Measure Output Voltage Ripple

When measuring output voltage ripple, care must be taken to avoid a long ground lead on the oscilloscope probe. A sturdy wire should be soldered to the output side of the GND terminal. The other end of the wire is looped around the ground side of the probe and should be kept as short as possible. The tip of the probe is touched directly to V_{OUT} (see Figure 3). Bandwidth is generally limited to 20MHz for ripple measurements. Also, if multiple pieces of line-powered test equipment are used, be sure to use isolation transformers on their power lines to prevent ground loops, which can cause erroneous results. Figure 4 shows the output voltage ripple with a steady-state load of 500mA for the LT1676.

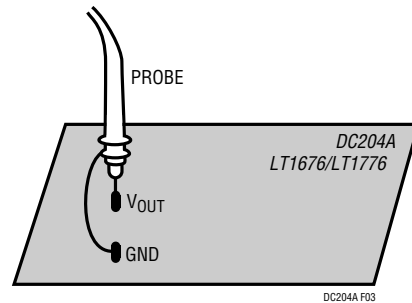

Figure 3. Measuring Output Voltage Ripple

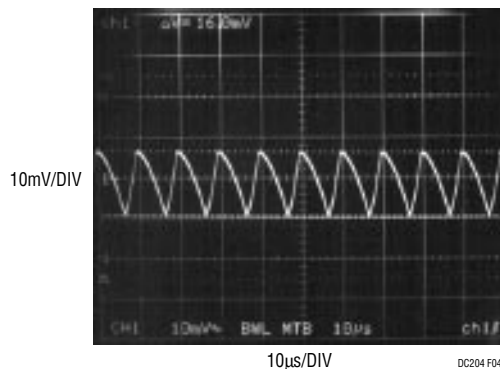

Figure 4. Output Voltage Ripple for the LT1676, $I_L = 500mA$

OPERATION

Heat Dissipation Issues

Since the LT1676/LT1776 include a 500mA onboard power switch, care must be taken not to exceed the maximum junction temperature for the part. A simple technique is to use the PC board as a heat sink. On the LT1676/LT1776 demo board, the power IC is surrounded by ground plane on both sides of the PC board. The two sides are connected through vias to better handle the power dissipation. If the LT1676/LT1776 are laid out on a multilayer board, there should be metal on the inner layers directly underneath the LT1676/LT1776. This helps in spreading heat and improves the power dissipation capability of the PCB.

Layout Guidelines

Since the LT1676/LT1776 are switching regulators, a good layout is essential for good load regulation and minimizing radiated/conducted noise. Be sure to follow these layout guidelines:

1. The LT1676/LT1776's V_{SW} pin and the Schottky diode, D1, should be placed as close as possible to each other.
2. The anode of Schottky diode D1 should be tied to input capacitor C1's ground by means of a wide trace, not via the ground plane.
3. Keep the trace from the FB pin to the junction of R1 and R2 short and use a long trace from the top of resistor R1 to the output terminal, rather than vice versa.
4. The grounds of output capacitors C6 and C7 should be tied directly to the ground plane.
5. The ground of the feedback resistors and the loop compensation resistor/capacitor (connected to the V_C pin) should be referenced to the chip ground pin, which, in turn, is directly tied to the input bulk capacitors' ground.
6. C2 should be as close as possible to Pin 5.

PCB LAYOUT AND FILM

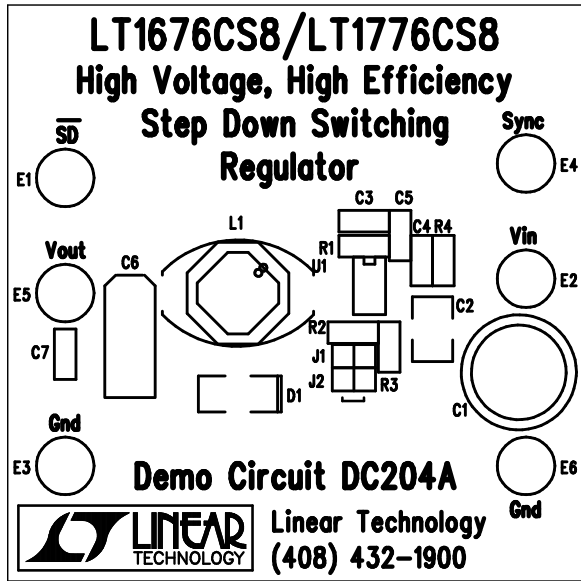

Silkscreen Top

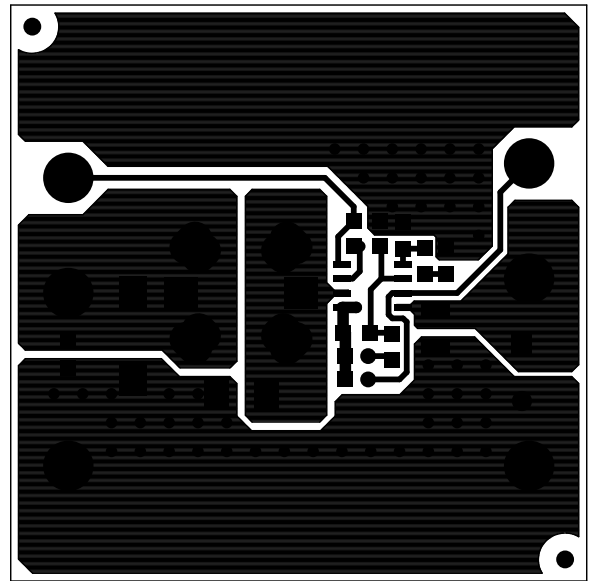

Component Side

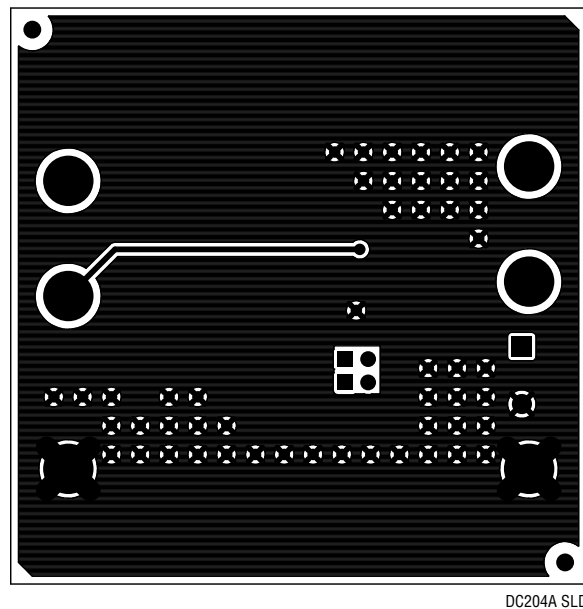

Solder Side

PCB LAYOUT AND FILM

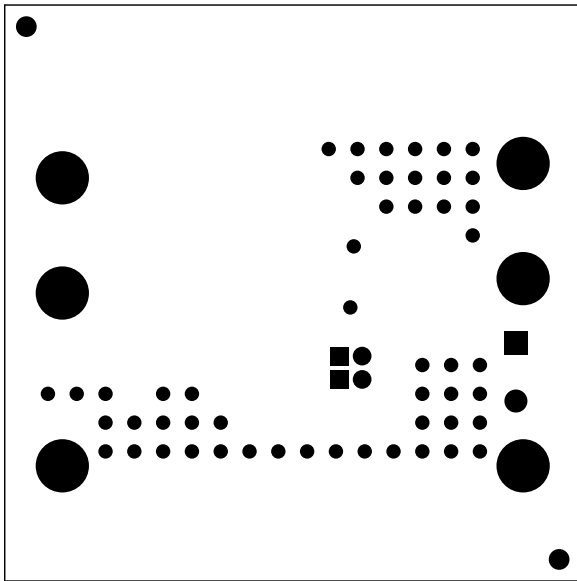

DC204A SMB

Solder Mask Bottom

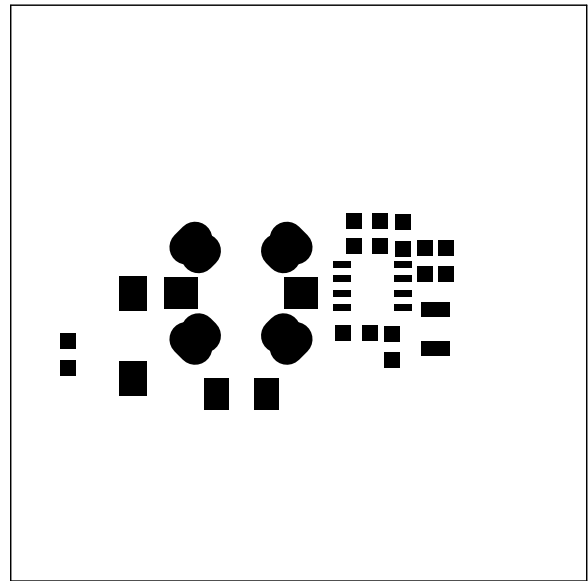

DC204A PMT

Paste Mask Top

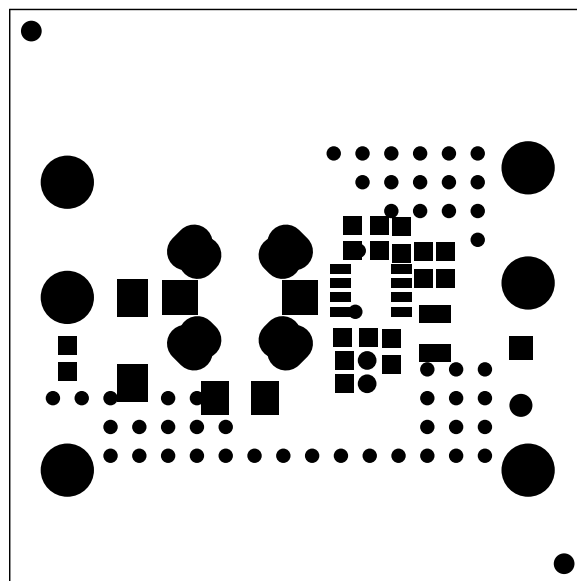

DC204A SMT

Solder Mask Top

DEMO MANUAL DC204

NO-DESIGN SWITCHER

PC FAB DRAWING

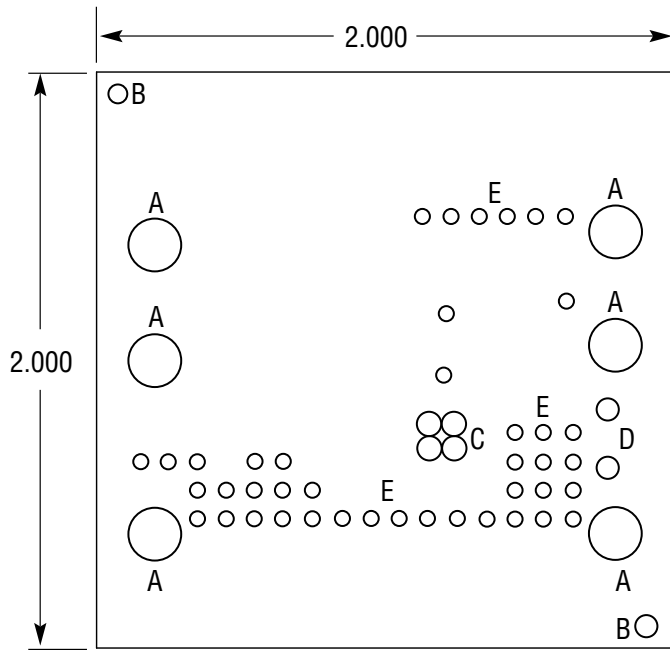

DC204A FAB

NOTES: UNLESS OTHERWISE SPECIFIED

1. MATERIAL: FR4 OR EQUIVALENT EPOXY, 2 OZ COPPER CLAD THICKNESS 0.062 ±0.006 TOTAL OF 2 LAYERS
2. FINISH: ALL PLATED HOLES 0.001 MIN/0.0015 MAX COPPER PLATE ELECTRODEPOSITED TIN-LEAD COMPOSITION BEFORE REFLOW, SOLDER MASK OVER BARE COPPER (SMOBC)
3. SOLDER MASK: BOTH SIDES USING SR1020 OR EQUIVALENT
4. SILKSCREEN: USING WHITE NONCONDUCTIVE EPOXY INK
5. ALL DIMENSIONS ARE IN INCHES

HOLE CHART

SYMBOL	DIAMETER	NUMBER OF HOLES	PLATED
A	0.095	6	YES
B	0.072	2	NO
C	0.030	4	YES
D	0.027	2	YES
E	0.020	51	YES