

RoHS compliant

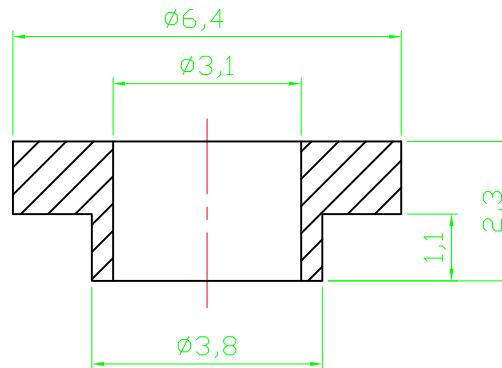

Notes
 Material:SR25
 Dielectric strength: 380kV/cm
 Heat resistance:215°C
 Tensile strength: 80N/mm

Scale	1:1					Date	Name	Customer-No.
TOLERANCE					Drawn	20.08.2009	Dean	
X.	$\pm X$				Approved	10.03.2010	Andy	ASSMANN WSW-No.
X.X	$\pm X$							V5731
X.XX	$\pm X$							Drawing-No.
DIM	TOL	②	Modify drawing layout	10.03.2010	Dean		ASS 0515 HS	rev02
X.°	$\pm X^\circ$	①	Drawn	20.08.2009	Dean		Replace	Sheet
X.X°	$\pm X^\circ$	①	Drawn	20.08.2009	Dean			
Angle	TOL	Id.	Modification	Date	Name			