

GEN. ST.	01	02	03	04	05	06	07	08	0D	50	60	70	80	90																	
INT. ST.	10	11	12	13	14	18	20	31	32	33	34	38	39	40	42	43	44	45	46	48	56	70	72	73	75	76	81	82	83	84	88

REV.	DATE	DESCRIPTION	BY	C 'K 'D'
A	2003-03-31	CONVERSION REVISION 0A	KN	
B	2008-12-06	108-0165	ALEX B	BKP

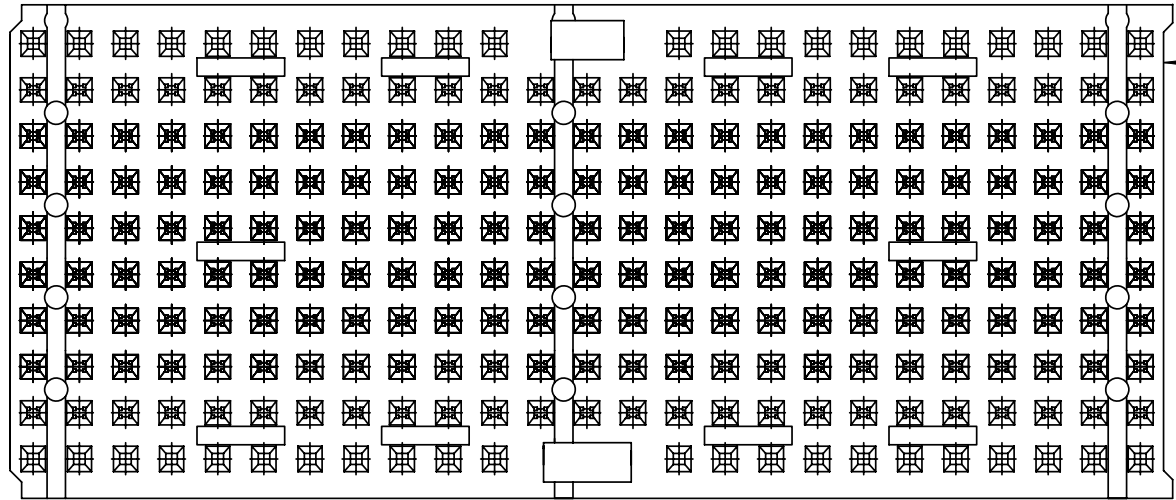

ABRIDGED CAT No MARKED



RoHS COMPATIBLE
(DIGIT 11 & 12)

HM2H95P1--LF

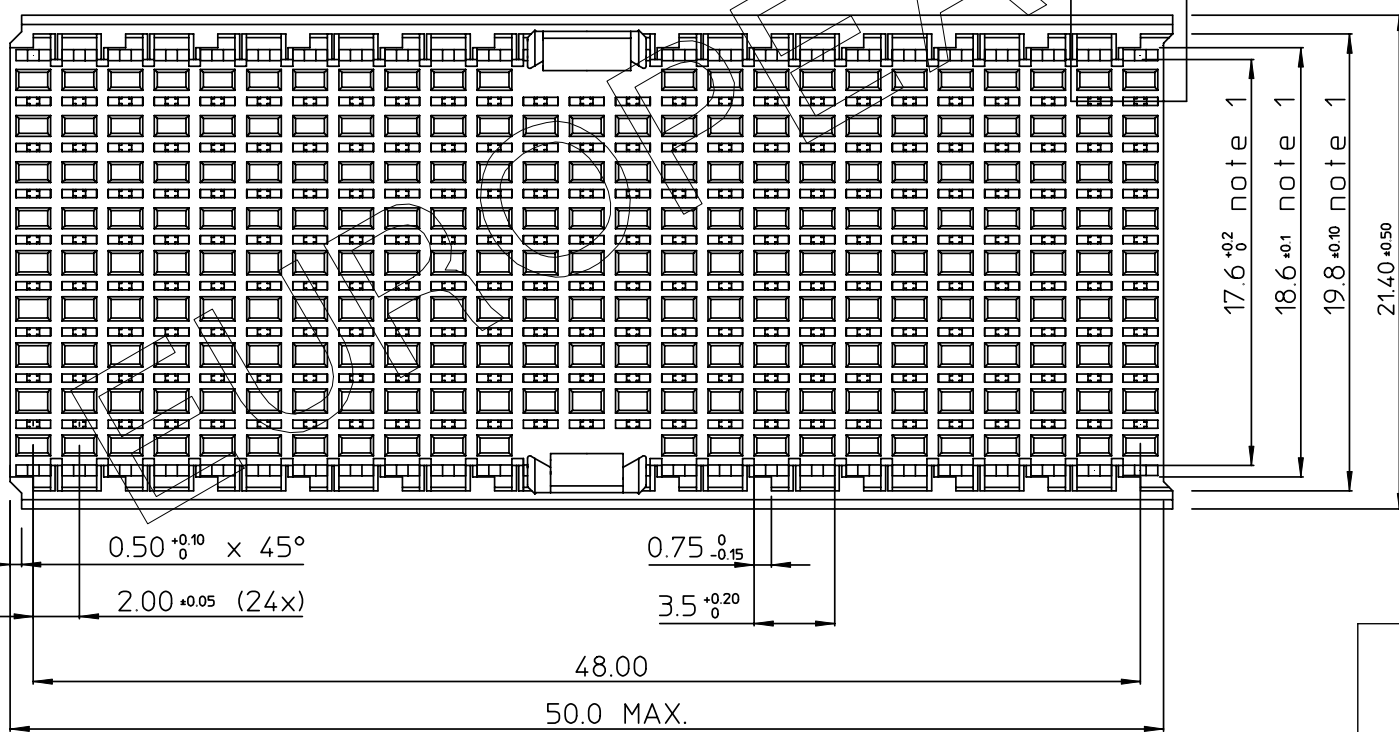
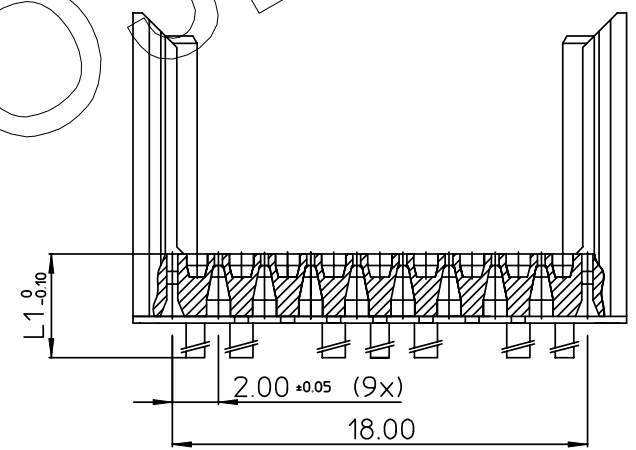
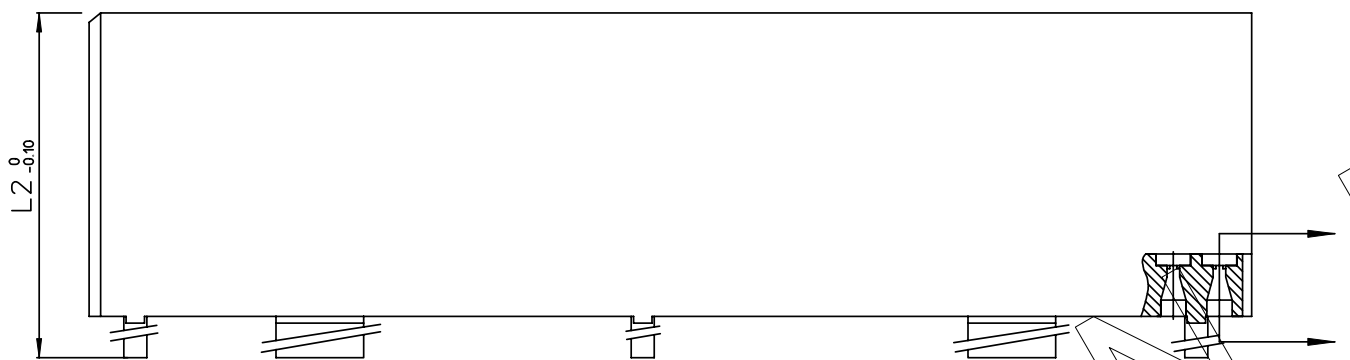
- NOTES:
1. MEASURED AT THE BOTTOM
 2. MATERIAL: GLASS REINFORCED POLYESTER UL94-V0
 3. THE "LF" PRODUCT MEETS EUROPEAN UNION DIRECTIVES AND OTHER COUNTRY REGULATIONS AS DESCRIBED IN GS-22-008.
 4. PARTS WITH AND WITHOUT SUFFIX LF TO THE PRODUCT PART NUMBER ARE IDENTICAL IN FORM, FIT AND FUNCTION. LF SUFFIX IS ADDED TO THE PART NUMBER OF THIS PRODUCT TO HAVE UNIFORM IDENTIFICATION OF ALL ROHS COMPATIBLE PRODUCTS.



PART NUMBER	L1	L2	
HM2H95P1LF	3.0	13.45	AVAILABLE
HM2H95P109LF	3.9	14.35	AVAILABLE
HM2H95P111LF	4.1	14.55	AVAILABLE
HM2H95P115LF	4.5	14.95	AVAILABLE
HM2H95P117LF	4.7	15.15	AVAILABLE
HM2H95P119LF	4.9	15.35	AVAILABLE
HM2H95P122LF	5.2	15.65	AVAILABLE

1DEC ±0.2 2DEC ±0.1 ANGLES ±1°	APPR.	DATE	SIGN.	MPACS 8+2R SHROUD TYPE DE
	DRAFT	2002-03-11	M.Fret	CAT. No. HM2H95P1--LF
WE RESERVE THE RIGHT TO CHANGE DIMENSIONS OR REQUIREMENTS WITHOUT PRIOR NOTICE.	CHECKED			 www.fciconnect.com
	PROD. MGR.			
	ALL DIMENSIONS IN MM	PR. ENG. MGR.		
	PR. MGT. MGR.			
	REFERENCES			
 				BS,C ,202311,013 DRAWING No. CUSTOMER DRAWING REVISION B

THIS IS OUR EXCLUSIVE PROPERTY. IT IS NOT TO BE COPIED, REPRINTED OR DISCLOSED TO A THIRD PARTY. NOR USED FOR MANUFACTURING WITHOUT OUR WRITTEN CONSENT. AND HAS TO BE RETURNED TO US IN CASE OF NO USAGE

DIT IS ONZE EIGENDOM EN MAG NOCH NAGEMAAKT, HERDRUKT, OVERGEMAAKT AAN DERDEN, NOCH VOOR FABRIKATIE GEBRUIKT WORDEN, ZONDER ONZE SCHRIFTELIJKE TOELATING. BIJ NIET GEBRUIK IS TERUGZENDING VERPLICHT.