

A large, light blue decorative graphic consisting of a thick, curved line that forms a partial circle, with a smaller circle at its top end, resembling a stylized 'C' or a partial orbit.

# Driving High Power LEDs Starting from 700mA with Low Cost LED Controller IC **ILD4001**

## Application Note 213

<http://www.infineon.com/lowcostleddriver>

Rev. 1.1, 2011 -06 -23

**Edition 2011-07-01**

**Published by**

**Infineon Technologies AG  
81726 Munich, Germany**

**© 2011 Infineon Technologies  
AG All Rights Reserved.**

#### **LEGAL DISCLAIMER**

THE INFORMATION GIVEN IN THIS APPLICATION NOTE IS GIVEN AS A HINT FOR THE IMPLEMENTATION OF THE INFINEON TECHNOLOGIES COMPONENT ONLY AND SHALL NOT BE REGARDED AS ANY DESCRIPTION OR WARRANTY OF A CERTAIN FUNCTIONALITY, CONDITION OR QUALITY OF THE INFINEON TECHNOLOGIES COMPONENT. THE RECIPIENT OF THIS APPLICATION NOTE MUST VERIFY ANY FUNCTION DESCRIBED HEREIN IN THE REAL APPLICATION. INFINEON TECHNOLOGIES HEREBY DISCLAIMS ANY AND ALL WARRANTIES AND LIABILITIES OF ANY KIND (INCLUDING WITHOUT LIMITATION WARRANTIES OF NON-INFRINGEMENT OF INTELLECTUAL PROPERTY RIGHTS OF ANY THIRD PARTY) WITH RESPECT TO ANY AND ALL INFORMATION GIVEN IN THIS APPLICATION NOTE.

#### **Information**

For further information on technology, delivery terms and conditions and prices, please contact the nearest Infineon Technologies Office ([www.infineon.com](http://www.infineon.com)).

#### **Warnings**

Due to technical requirements, components may contain dangerous substances. For information on the types in question, please contact the nearest Infineon Technologies Office.

Infineon Technologies components may be used in life-support devices or systems only with the express written approval of Infineon Technologies, if a failure of such components can reasonably be expected to cause the failure of that life-support device or system or to affect the safety or effectiveness of that device or system. Life support devices or systems are intended to be implanted in the human body or to support and/or maintain and sustain and/or protect human life. If they fail, it is reasonable to assume that the health of the user or other persons may be endangered.



---

**Application Note AN213**

**Revision History: 23 June 2011**

**Previous Revision: Previous\_Revision\_Number**

<b>Page</b>	<b>Subjects (major changes since last revision)</b>

## Table of Contents

1	<b>Introduction</b> .....	5
2	<b>Application Information</b> .....	8
3	<b>Characteristic Graphs for different Inductors, no. of LEDs, Rs</b> .....	13
4	<b>Evaluation Board and layout Information</b> .....	16
5	<b>Equations for estimating switching frequency or Inductance</b> .....	19

## List of Figures

Figure 1	ILD4001 .....	5
Figure 2	Schematic of the demonstration board.....	8
Figure 3	Measurement setup for measuring Vsense voltage w.r.t. Vs pin .....	9
Figure 4	Vsw, Vsense and VLED(-), Vs=12 .....	9
Figure 5	Switching Freq. vs Input Voltage, Vs.....	9
Figure 6	Dimming waveforms .....	10
Figure 7	Maximum Contrast Ratio vs Dimming frequency (100:1=1% Duty).....	10
Figure 8	Analog Dimming Characteristic .....	10
Figure 9	EN pin current versus voltage .....	12
Figure 10	I <sub>LED</sub> vs Vs (Rs = 0.158, L = 68µH) .....	13
Figure 11	I <sub>LED</sub> vs Vs (Rs = 0.075, L = 33µH) .....	13
Figure 12	Freq vs Vs (Rs = 0.158, L = 68µH).....	13
Figure 13	Freq vs Vs (Rs = 0.075, L = 33µH).....	13
Figure 14	Efficiency vs Vs (Rs = 0.158, L = 68µH).....	14
Figure 15	Efficiency vs Vs (Rs = 0.075, L = 33µH).....	14
Figure 16	I <sub>LED</sub> vs Ambient Temperature .....	15
Figure 17	Efficiency vs Ambient Temperature.....	15
Figure 18	Solder Point Temperature vs Ambient Temperature.....	15
Figure 19	Photograph of Demo Board using BSP381S external MOSFET (size of PCB: 50mm x 30mm).....	16
Figure 20	PCB Layer Information Top View .....	16
Figure 21	PCB Layer information Bottom View (unflip).....	16
Figure 22	Thermal Resistance of PCB-FR4 versus Ground Copper Area.....	17
Figure 23	Thermal Resistance .....	18

## List of Tables

Table 1	Demo Board for ILD4001 .....	6
Table 2	Comparison of BSP318S, BSR302N and BSS306N .....	6
Table 3	Bill-of-Materials.....	8
Table 4	Percentage of max LED current vs DC voltage at PWM pin .....	11
Table 5	Steps to calculate the switching frequency for the demo board.....	19

## 1 Introduction

### 1.1 Features

- Wide Input Voltage Range: 4.5 V ... 42 V
- Capable to drive N-channel MOSFETs that provide up to 3A output
- Temperature shut down mechanism
- Switching frequency up to 500 kHz
- Analog and PWM dimming possible
- Typical 3% output current accuracy
- Very low LED current drift over temperature
- Minimum external component required
- Small Package: SC-74

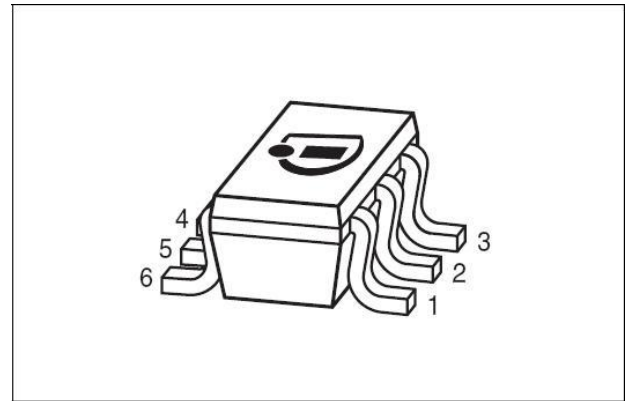

**Figure 1** ILD4001

### 1.2 Applications

- LED controller for indoor and outdoor illumination
- LED replacement lamps, e.g. MR16 halogen replacement
- Retail, office and residential high power luminaires
- Architectural lighting
- Downlights and light engines
- Appliances, e.g. fridge / freezer

### 1.3 Description

This document contains informations about the LED-Less Demonstration Board for ILD4001. Please refer to the datasheet for the pins descriptions, functions descriptions and specifications.

The ILD4001 is a hysteretic buck LED controller IC for industrial applications.

The LED Controller is capable to drive external bipolar or MOSFET power transistors by using the internal push-pull output stage.

ILD4001 maintains a constant current through a string of LEDs as long as the input voltage exceeds the sum of the forward voltages of the LEDs in the string by at least 3V. The maximum input voltage for this demonstration board must not exceed 30V due to the board is optimizing for the 30V operation. If there is a need to test the board with a maximum supply voltage of 42V, please replace the schottky diode SD1 and the external MOSFET T1 with a suitable breakdown voltage.

The precise internal bandgap stabilizes the circuit and provides stable current conditions over temperature range.

Furthermore, temperature shut down mechanism enforce the IC to protect attached LEDs.

The board includes an “EN/PWM” **input terminal for** digital or analog dimming control signal.

The demonstration board is designed to operate at ambient temperatures up to 100°C.

The complete demonstration board schematic is shown in Figure 2. Typical waveforms and performance curves are shown in Figure 4 to Figure 8.

Although a wide variety of LED combinations and currents can be driven with the ILD4001, the sense-resistors have to be altered to achieve the desire LED current and inductance has to be changed to attain recommended switching frequencies below 500 kHz.

**Table 1 Demo Board for ILD4001**

Board Name	R1,R2,R3 /Ω	L1 /μH	External MOSFET	Vs /V	Suitable number of LEDs	Typical Switch. Freq. /kHz	Measured Vrsense = Vs - VLED+ /V	LED Average Current /A	Ambient temp. less than /°C
0.7A	0.47	68	BSR302N	12	3	224	0.115	0.74	90 <sup>1</sup>
1.0A	0.33	47	BSP318S	12	3	222	0.116	1.06	90 <sup>1</sup>

The above measured values are for typical case only.

### 1.3.1 Check List before powering up

Before powering on the ILD4001 demonstration board, please verify the following:

- Be sure that each LED can conduct 1000mA DC current within its safe region of operation.
- Make sure that the input voltage supply is less than 30V.
- Select the appropriate mode for EN/PWM:
  - to enable the ILD4001, please force the EN/PWM pin terminal to 3V or more, and
  - to select analog dimming, supply a dc source (1 to 3V) to EN/PWM pin terminal.
  - to select PWM dimming, supply a PWM signal source (0 to 5V) with frequency within range of (200Hz to 5 kHz) to PWM pin terminal.
- For the case when operating the EN/PWM pin less than 1V, please insert a 10kΩ resistor between the gate and source of the external MOSFET.

### 1.3.2 External MOSFET

The external MOSFET T1 is required to drive the LEDs in the ILD4001 application. There are a few factors to consider while choosing the suitable external MOSFET. First, choose the correct voltage and current rating of the MOSFET. Please ensure the VDS breakdown and current capability is sufficient, and ensure that the external MOSFET working within the SOA<sup>2</sup> region of DC mode. Second, the logic high level from ILD4001 is 5V and the external MOSFET must be able to be driven with a 5V gate voltage. Third, choose a low Rds(on) MOSFET. It can improve the efficiency of the system.

The BSR302N, BSS306N and BSP318S are recommended. Please refer to Table 2 for the external MOSFET comparison. BSR302N offer the lowest Rds(on), highest efficiency and the ILED can operate up to 3.7A. BSP318S is suitable for the application up to Vs = 60V, also better in Rth and the ILED can operate up to 2.6A. BSS306N offer the lowest cost, suitable for the application of ILED up to 2.3A. The efficiency not as good as BSR302N but comparable to BSP318S.

**Table 2 Comparison of BSP318S, BSR302N and BSS306N**

	BSP318S	BSR302N	BSS306N
Package	SOT-223	SC-59	SOT23
Rds(on)	90m	36m	93m
VDS	60V	30V	30V
Max ILED	2.6A	3.7A	2.3A
RthJA	100K/W	250K/W	250K/W

<sup>1</sup> Demo board without heatsink

<sup>2</sup> Safe Operation Area

### 1.3.3 Capacitor C20 for Ripple Reduction

This component C20 is optional and not installed on the standard demo board. This capacitor can help to reduce LED ripple current. Recommended to use low ESR<sup>1</sup> capacitor and its rated voltage must be higher than the maximum input voltage.

### 1.3.4 Connection of LEDs

The ILD4001 demo board includes a 3-pin SIP<sup>2</sup> connector for the anode connection (LED +) and a 2-pin SIP connector for the cathode connection (LED -) of the **“LEDs in series”**. **The anode connection is labeled as CON1-3** and cathode connection is labeled as *CON2-1* on the board.

### 1.3.5 PWM Dimming

The PWM terminal on the PCB is an input for the pulse width modulated (PWM) signal to control the dimming of **the LED string. The PWM signal's logic high level should be at least 2.5V or higher.** The period of this PWM signal should be higher than 200 $\mu$ s. For the default demo board circuit, a dimming frequency less than 300Hz is recommended to maintain a maximum contrast ratio of at least 100:1. The maximum contrast ratio is shown on Figure 7, and the minimum is based on the measured average LED current at 3dB above/below the linear reference. The maximum contrast ratio depends largely on the rise time of the inductor current, and hence is dependent on input voltage, inductor size and LED string forward voltage. In addition, if C20 is installed, the maximum contrast ratio or DIM frequency will be further reduced. Please insert a 10k $\Omega$  resistor between the **MOSFET's gate and ground. This is due to the output stage of ILD4001 become high impedance state** when the PWM signal is lower than 0.7V. With the 10k $\Omega$  resistor, a dimming PWM frequency up to 5 kHz is possible.

### 1.3.6 Open Circuit of terminals LED+ and LED-

If the LED array is disconnected or fails with open state, the ILD4001 will operate at 100% duty cycle. The output voltage (at LED+) will rise to the level of the input voltage. The other output terminal (LED -) will fall to ground. Note that under the above said condition; please avoid reconnecting the LED array between LED+ and LED- terminals without powering down first. This precaution is to avoid excessive surge current that may damage the LEDs.

---

<sup>1</sup> Equivalent Series Resistance

<sup>2</sup> Single In-line Package

## 2 Application Information

### 2.1 Schematic

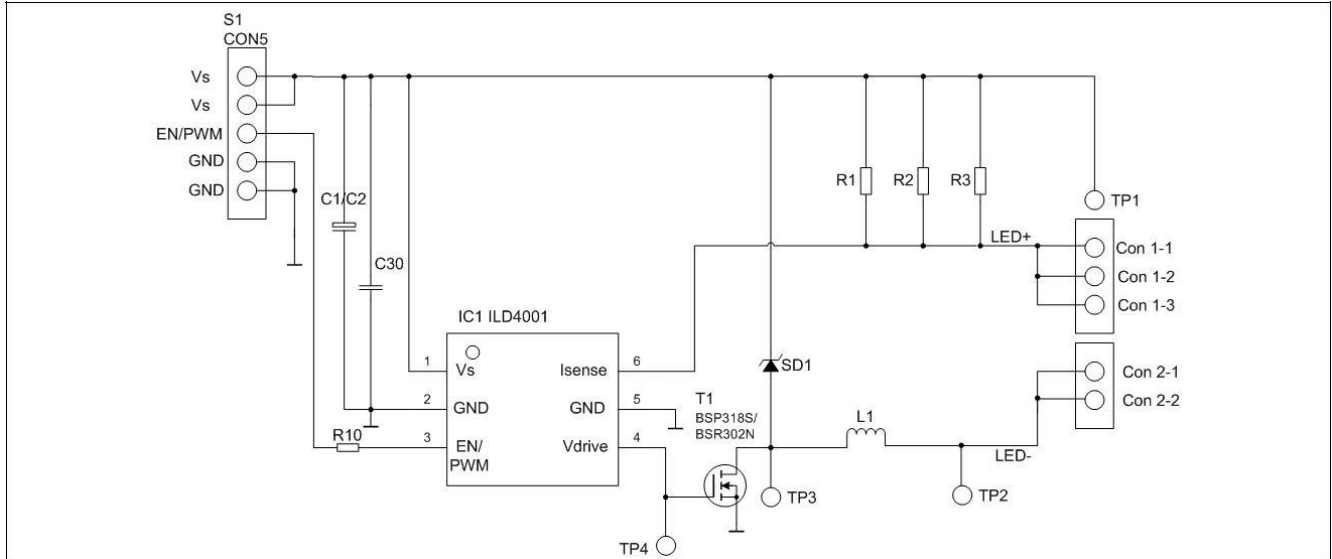

**Figure 2** Schematic of the demonstration board

**Table 3** Bill-of-Materials

Symbol	Value	Unit	Size	Manufacturer	Comment
L1	*see Table 1	$\mu\text{H}$	10.4x10.4mm / 8x8mm	EPCOS / TAIYO YUDEN	Shielded Power Inductor
R1	*see Table 1	$\Omega$	1206		Part of the current sense resistor
R2	*see Table 1	$\Omega$	1206		Part of the current sense resistor
R3	*see Table 1	$\Omega$	1206		Part of the current sense resistor
R10	0	$\Omega$	0805		Jumper
SD1	BAS3020B		SOT363	INFINEON	Medium Power AF Schottky Diode 2A 30V
IC1	ILD4001		SC-74	INFINEON	Hysteretic Buck controller and LED driver
T1	*see Table 1		PG-SC-59 / PG-SOT-223	INFINEON	OPTIMOS <sup>®</sup> 2 / SIPMOS <sup>®</sup> Small Signal Transistor
C30	4.7	$\mu\text{F}$	1812		Ceramic, 50V



## 2.2 Recommended method to measure Vsense w.r.t. Vs pin

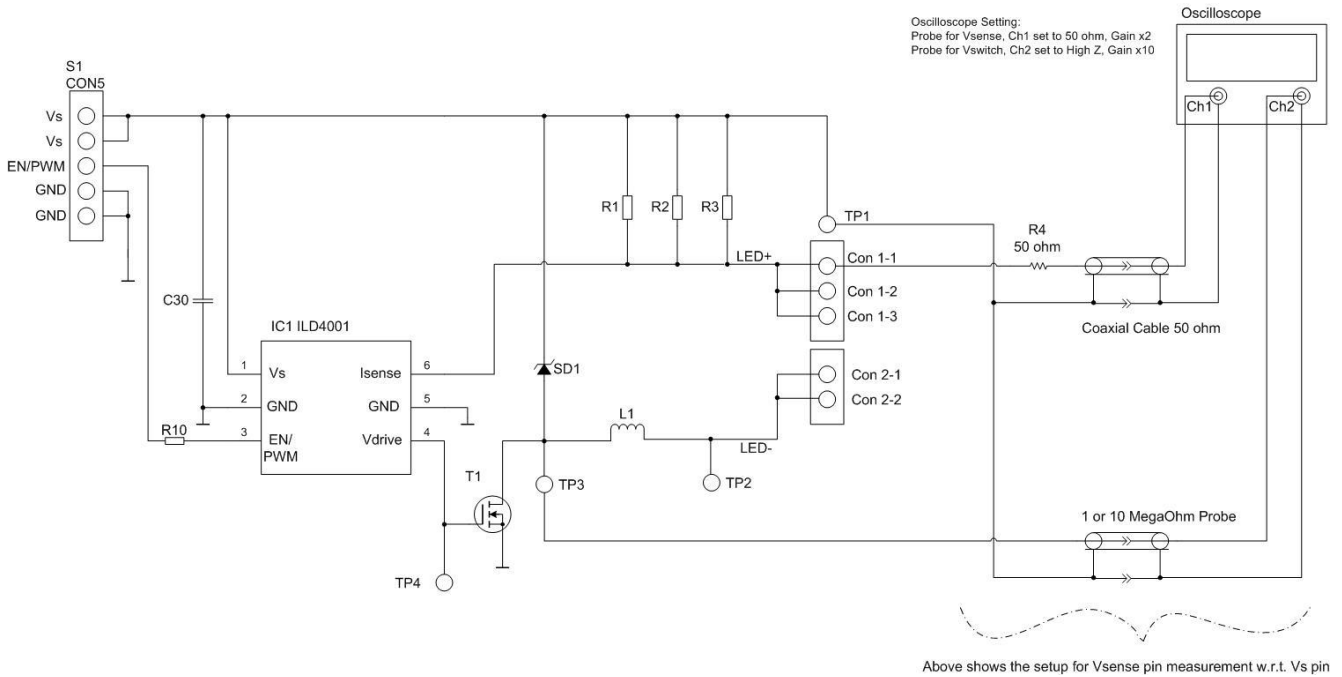
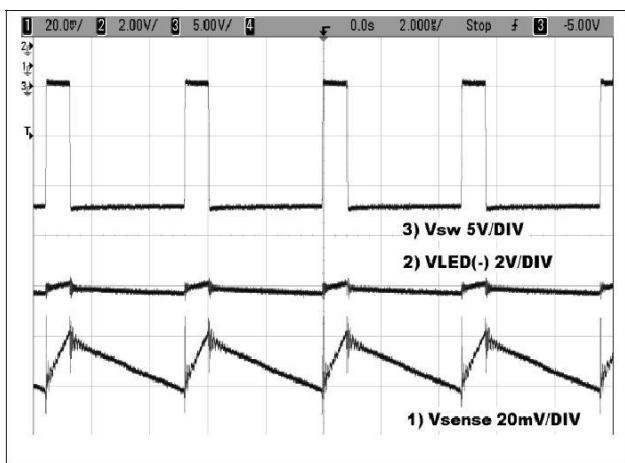

**Figure 3 Measurement setup for measuring Vsense voltage w.r.t. Vs pin**

By probing Vsense pin voltage with reference to Vs pin, it facilitates the observation and measurement of the ripple and average of Vsense voltage **at the same time with “Oscilloscope set to DC coupling”**, and without offsetting the DC voltage. This is shown in Figure 4.

## 2.3 Measured Graphs of the demonstration boards

Unless otherwise specified, the following condition labels apply:  
Condition: Vs=12V, Ta=25°C, 700mA demo board with BSR302N



**Figure 4 Vsw, Vsense and VLED(-), Vs=12**

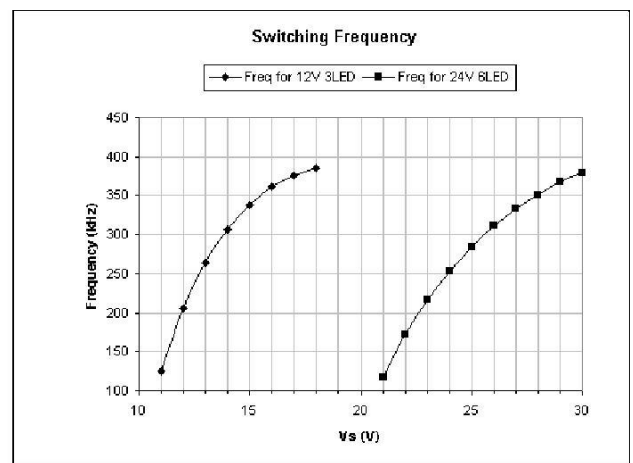

**Figure 5 Switching Freq. vs Input Voltage, Vs**

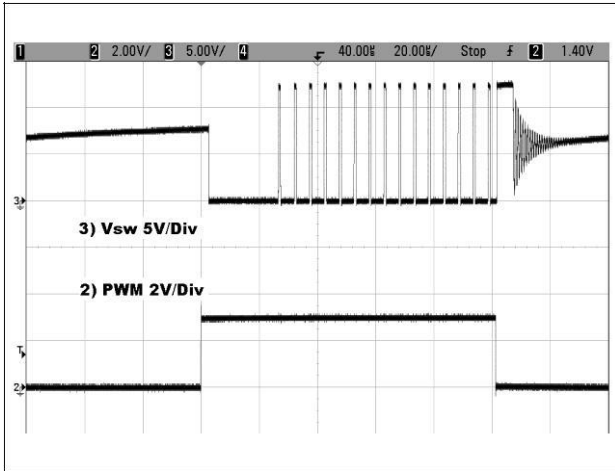

Figure 6 Dimming waveforms

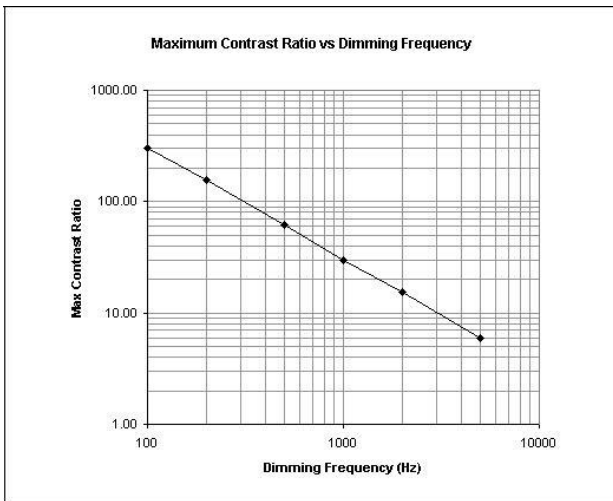

Figure 7 Maximum Contrast Ratio vs Dimming frequency (100:1=1% Duty)

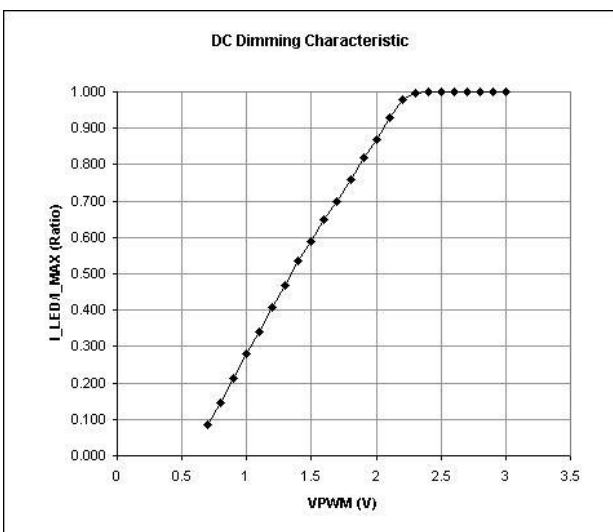

Figure 8 Analog Dimming Characteristic

## 2.4 Analog Dimming Characteristic

The analog dimming characteristic graph is shown Figure 8. To achieve a linear change in LED current versus control voltage, the recommended range of voltage at EN/PWM pin is from 1.0V to 2.0V.

**Table 4 Percentage of max LED current vs DC voltage at PWM pin**

Ven_pwm /V	Percentage of max. LED Current / %
< 0.4	0
1.0	25
1.4	50
1.8	75
2.1	90
>2.4	100

## 2.5 Setting the nominal LED current

The internal reference for the voltage across the external sense resistor was design to be 0.121V as stated in the datasheet. A first order approximation for the LED current can be calculated with this formula:

$$I_{LED} = \frac{V_{sense}}{R_{sense}} = \frac{0.121V}{R_{sense}}$$

If a certain level of LED current is desired; the estimation for the Rsense is given by:

$$R_{sense} = \frac{V_{sense}}{I_{LED}} = \frac{0.121V}{I_{LED}}$$

The Vsense can vary depending on the number of LEDs and voltage supply. Please take reference from Figure 10 and Figure 11 to help select the Rsense for your application.

## 2.6 External pull-up resistor for EN pin

The input stage of the EN pin is an NPN transistor with high ohmic base resistor. With a higher voltage apply at the EN pin; the current flowing into the EN pin will become higher. This result a lower efficiency of the system due to the current flowing into EN pin is increased. Figure 9 shows the relationship of the EN pin input current with respect to the EN pin voltage.

To improve this, by adding an external resistor between the EN pin and the Vs pin can reduce the current hence improve the system efficiency.

The value of the external resistor depends on the operating supply voltage; Vs. An approximation of the external resistance is given by:

$$R_{EN} = \frac{V_s - V_{EN}}{I_{EN}}$$

Where I<sub>EN</sub> is 250µA as maximum, provided in the datasheet.

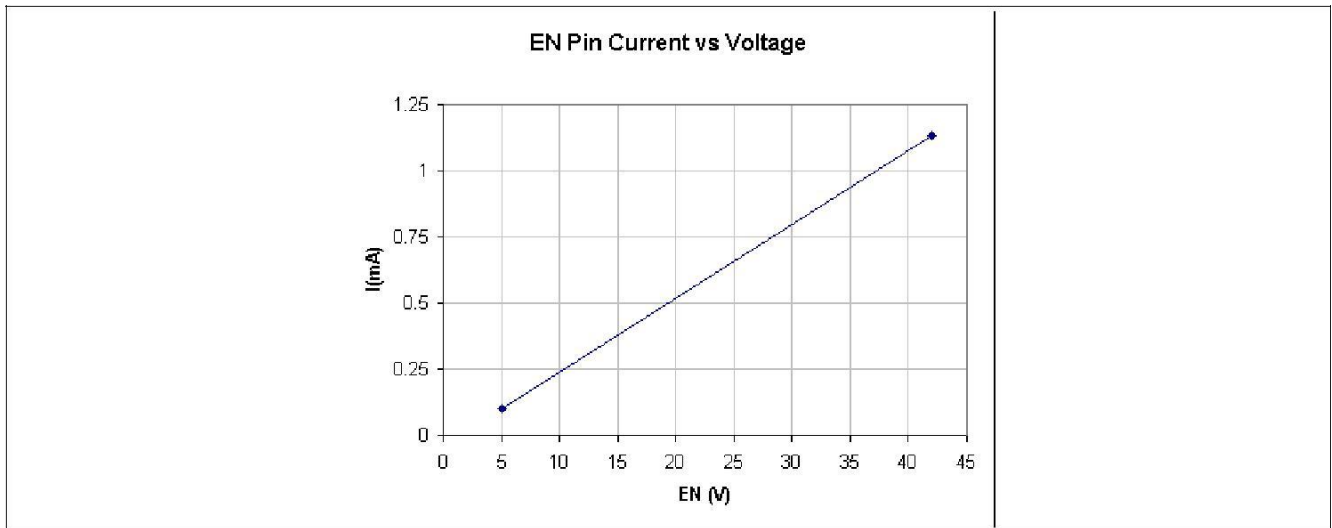

Figure 9 EN pin current versus voltage

### 3 Characteristic Graphs for different Inductors, no. of LEDs, Rs

#### 3.1 Vsense, ILED versus Supply Voltage Characteristics

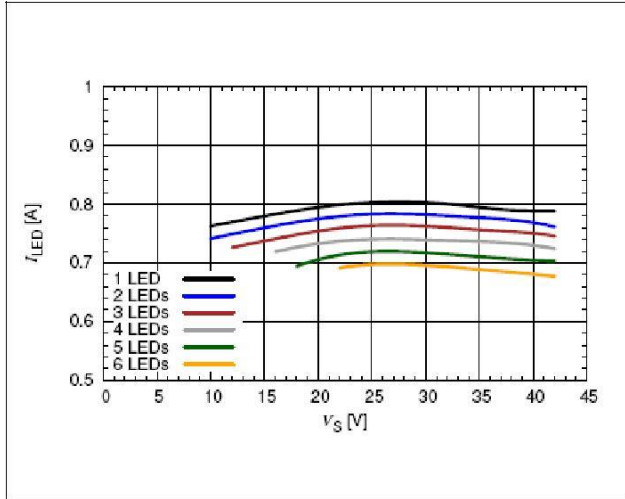

Figure 10 ILED vs Vs ( $R_s = 0.158$ ,  $L = 68\mu H$ )<sup>1</sup>

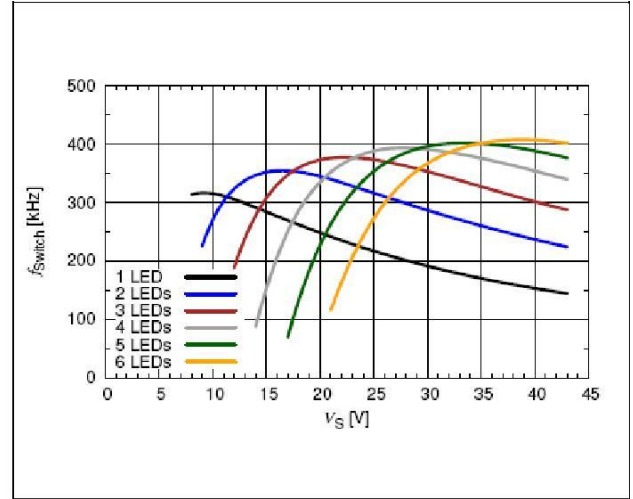

Figure 12 Freq vs Vs ( $R_s = 0.158$ ,  $L = 68\mu H$ )<sup>1</sup>

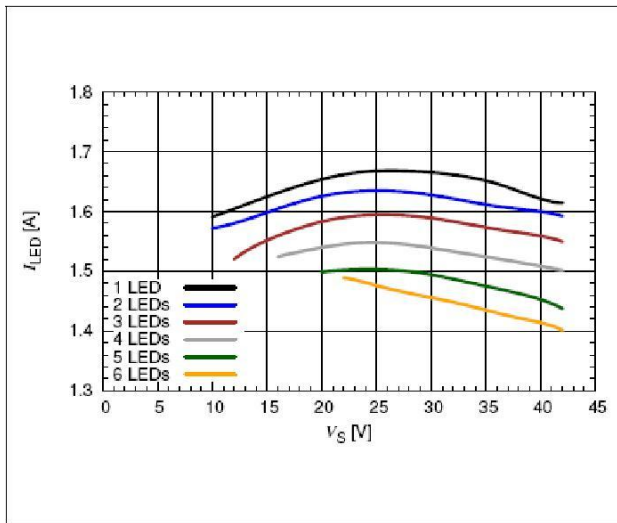

Figure 11 ILED vs Vs ( $R_s = 0.075$ ,  $L = 33\mu H$ )<sup>1</sup>

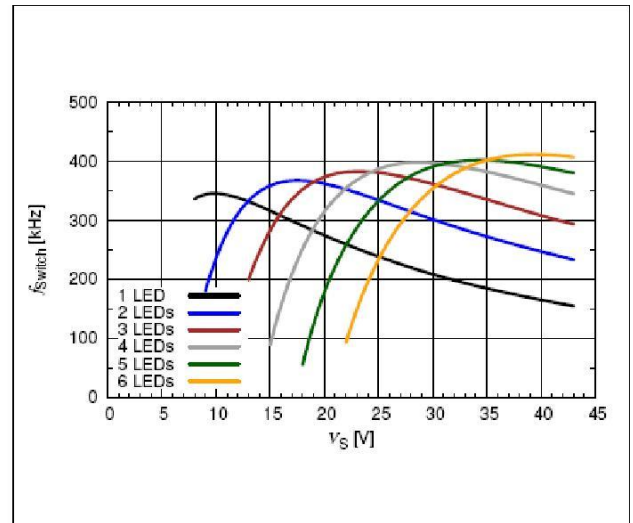

Figure 13 Freq vs Vs ( $R_s = 0.075$ ,  $L = 33\mu H$ )<sup>1</sup>

<sup>1</sup> Using BSP318S as external MOSFET

### 3.2 Efficiency versus Supply Voltage Characteristic

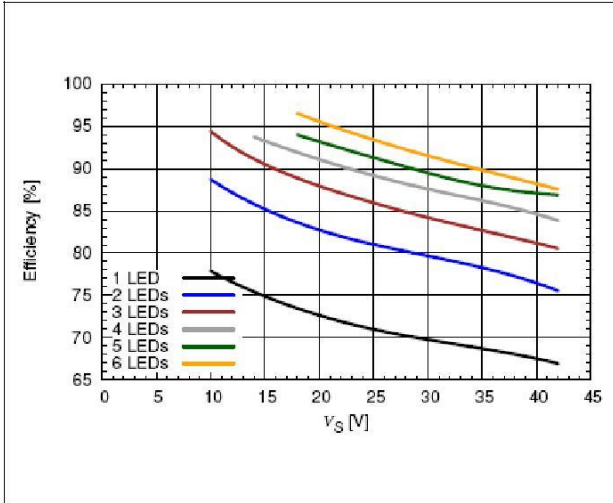

Figure 14 Efficiency vs Vs ( $R_s = 0.158$ ,  $L = 68\mu\text{H}$ )<sup>1</sup>

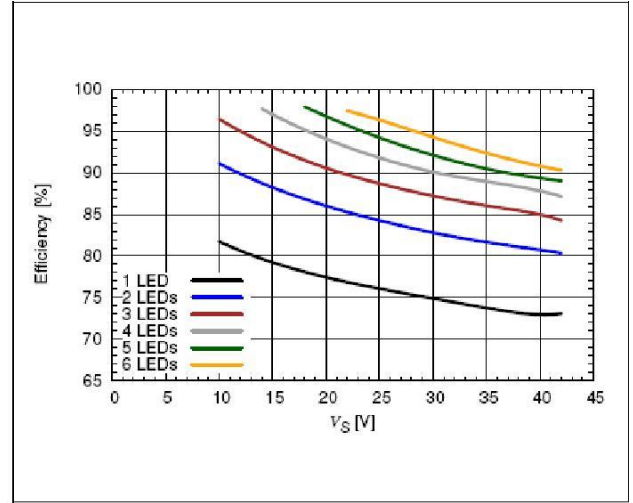

Figure 15 Efficiency vs Vs ( $R_s = 0.075$ ,  $L = 33\mu\text{H}$ )<sup>1</sup>

<sup>1</sup> Using BSP318S as external MOSFET

### 3.3 Temperature Characteristics (Rs=0.11Ω L=68μH)

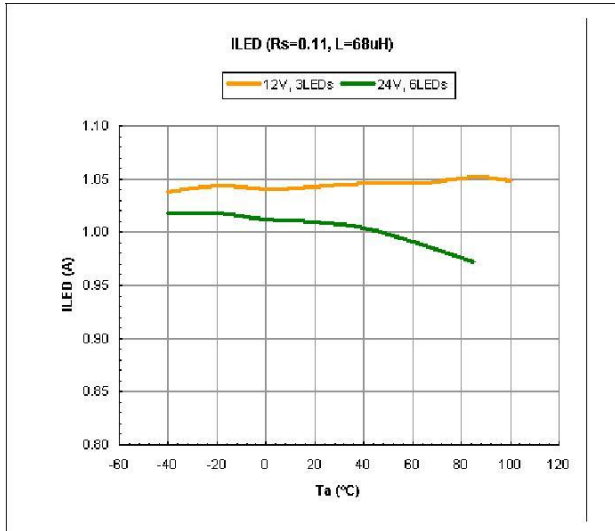

Figure 16 ILED vs Ambient Temperature

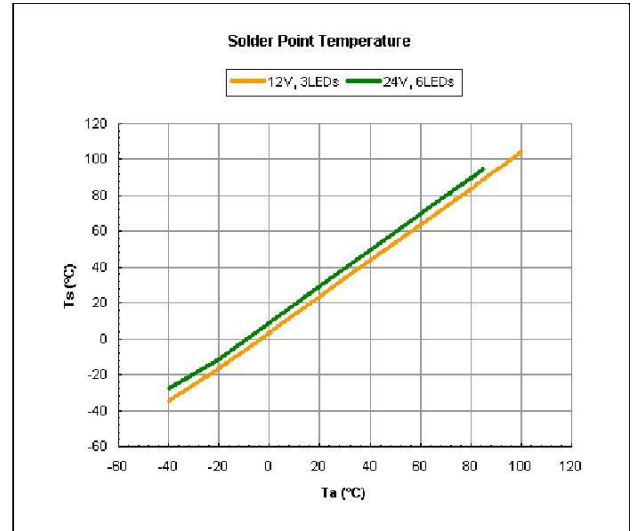

Figure 18 Solder Point Temperature vs Ambient Temperature.

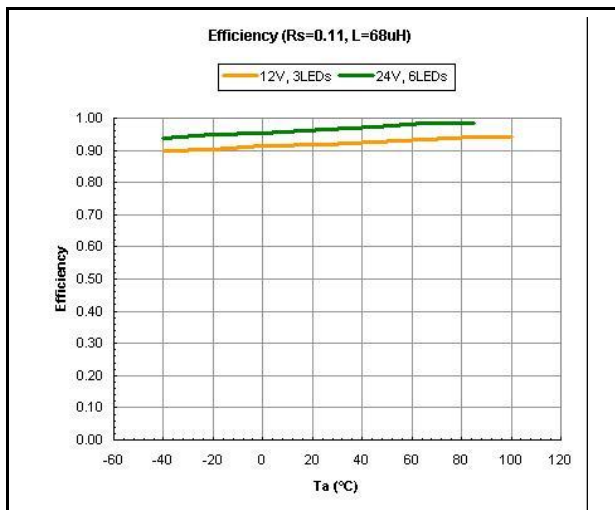

Figure 17 Efficiency vs Ambient Temperature

## 4 Evaluation Board and layout Information

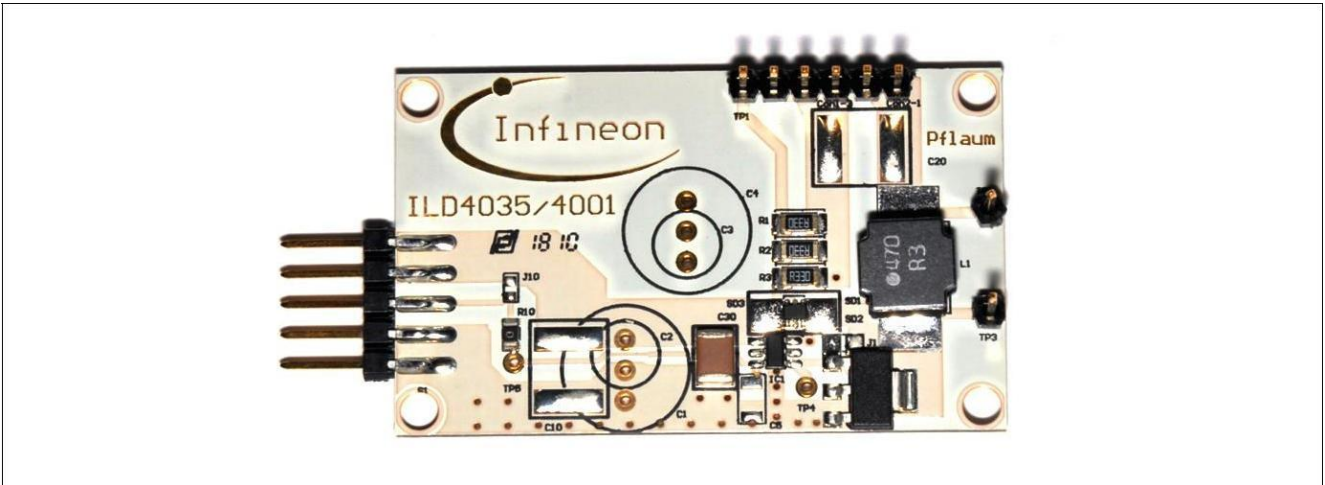

Figure 19 Photograph of Demo Board using BSP318S external MOSFET (size of PCB: 50mm x 30mm)

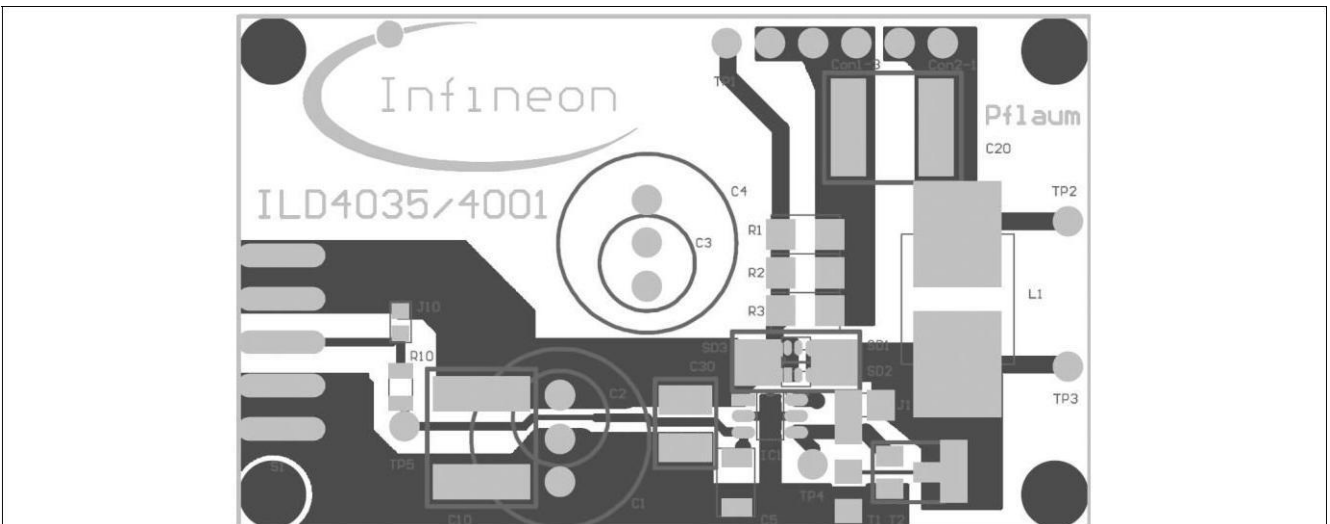

Figure 20 PCB Layer Information Top View

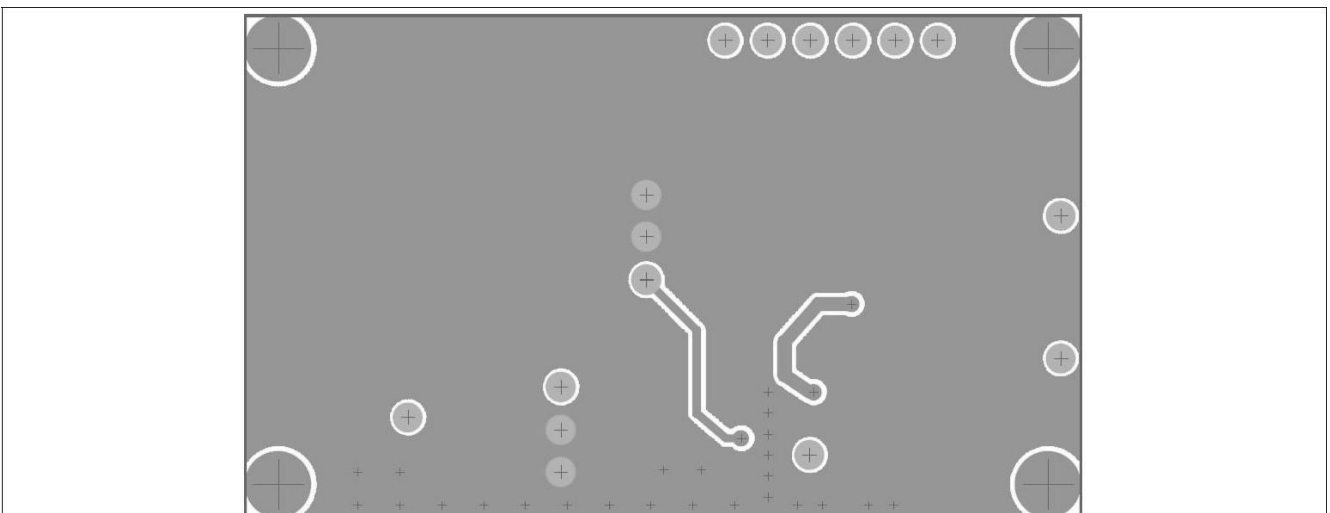

Figure 21 PCB Layer information Bottom View (unflip)



## 4.1 PCB Consideration

The free-wheeling diode's path from inductor to Vs pin of the integrated circuit is recommended to be as short a distance as possible. This is to minimize oscillation in the system.

The energy storage capacitor between Vs and Gnd is recommended to be placed as near to the IC as possible. This helps to stabilize the supply voltage when the IC draws large instantaneous current during switching.

Ground plane should be as large as possible to improve heat dissipation.

As a reference for designing the surface area for the grounding for the PCB using FR4 to achieve a certain thermal resistance between desired solder point temperature and expected ambient temperature, the following chart can be used.

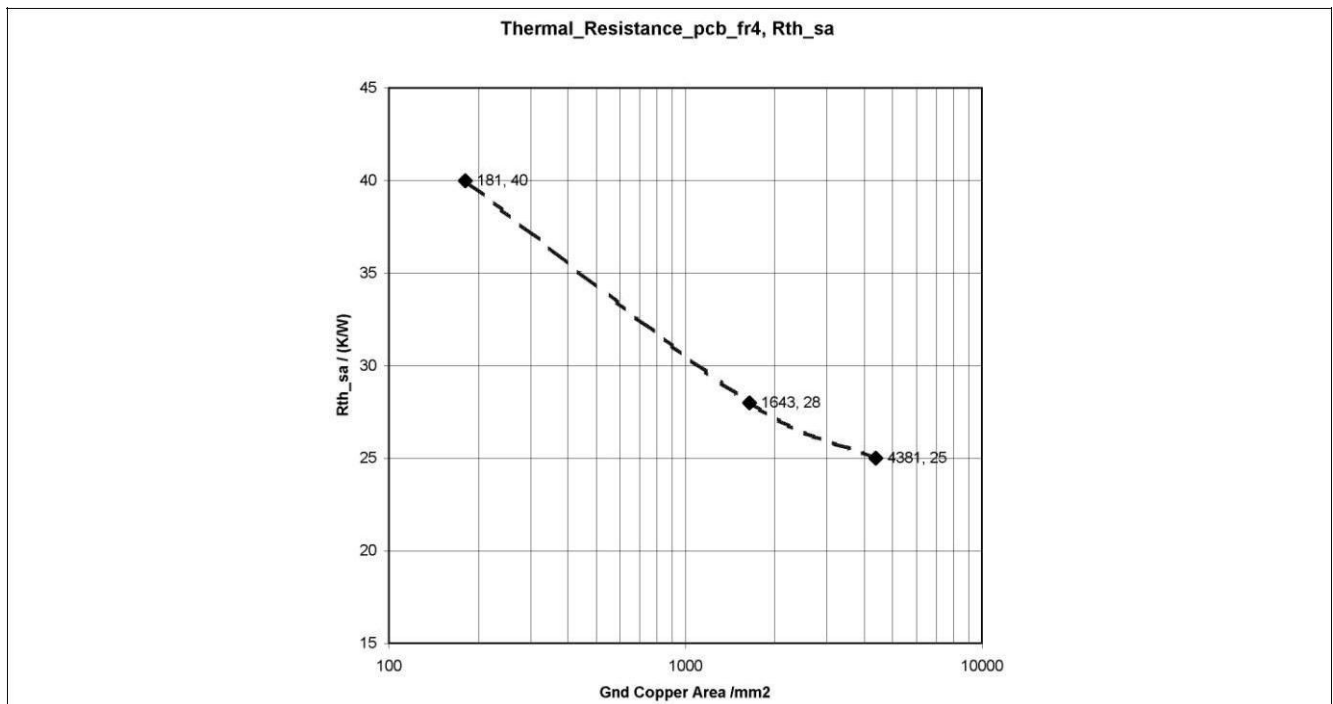
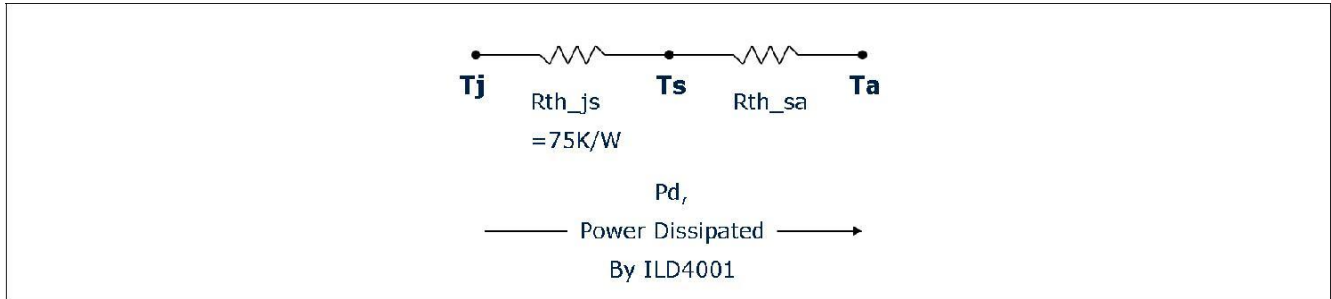

**Figure 22 Thermal Resistance of PCB-FR4 versus Ground Copper Area**

The data in the above Figure 22 were measured with following conditions:

- Two copper layers.
- 2 oz copper (70um thick) and board thickness of about 1.6mm.
- Ground pin connection of the IC is used to dissipate heat.
- FR4 material.
- No forced convection.
- No heat sink.
- No special mask opening for improved heat dissipation.
- In the chart, only three points are marked by diamond symbol. These are measured data. The broken line represents intermediate points which can be derived by linear interpolation.

An example where ILD4001's PCB is separated from LED PCB and there is not heat transmission between the two PCBs.



**Figure 23 Thermal Resistance**

$T_j$  is the junction temperature of the ILD4001's output transistor connected to switch pin.

$T_s$  is the soldered temperature of the ILD4001's ground pin to FR4-PCB.

$T_a$  is the ambient temperature.

$R_{th\_js}$  is the thermal resistance from junction to soldered point with reference to ILD4001's SC-74 package. This is stated as 70K/W in the datasheet.

$R_{th\_sa}$  is the thermal resistance from soldered point to ambient which is dependent on size of grounding area of PCB.

$P_d$  is the power dissipated by ILD4001 which is approximately 10% of total power from supply (for rough calculation), or it can be derived by (Total power from supply – LEDs' power – Power Loss on other external components).

The above variables are related in the equations on the next line.

$$P_d = \frac{T_j - T_s}{R_{th\_js}} = \frac{T_s - T_a}{R_{th\_sa}}$$

With the above equations, and setting  $T_j$  (recommended to be below 100°C), the  $T_s$  can be calculated.

By choosing a desired  $T_a$ , the  $R_{th\_sa}$  can be calculated.

With the calculated  $R_{th\_sa}$ , reference Figure 22 to correlate the approximated ground copper area required in PCB layout.

## 4.2 High power LED application design consideration

The ILD4001 is also suitable for the high power LED application. With a proper MOSFET and configure the LED current up to 3A, the ILD4001 is able to drive the LEDs up to 60W for a 24V input supply voltage.

Below are the design considerations for the high power application:

- Use a low  $R_{ds(on)}$  external MOSFET.
- The  $R_s$  is critical for high power application, use a wide terminal SMD resistor and place it as close to  $V_s$  and  $I_{sense}$  terminal as possible.
- For PCB, layout the copper track connected  $V_s$  and  $R_s$  as short as possible to reduce the copper resistance.

## 5 Equations for estimating switching frequency or Inductance

### 5.1 Estimation of switching frequency

**Table 5 Steps to calculate the switching frequency for the demo board**

	Board Versions	0.7A	Units
Force	$V_S =$	input voltage =	12 V
Assume	$V_{rsense} =$	voltage across sense resistor =	0.116 V
Assume	$V_{LED} =$	avg voltage of one LED =	3 V
Assume	$N =$	number of LEDs =	3 pcs
Assume	$V_{LED \times N} =$	voltage across LED+, LED- =	9 V
Assume	$V_T =$	voltage at Vswitch (low state) =	0.1 V
Assume	$V_D =$	on-voltage of schottky diode =	0.38 V
Use	$R_{sense} =$	effective sense resistance =	0.157 ohm
Use	$L =$	Inductance =	68 uH
<b>1.) Set LED average current <math>I_{average}</math></b>			
	$I_{LEDavg} =$	$V_{rsense} / R_{sense} =$	0.739 A
	factor =	ratio of (Peak to Peak change of LED current) to (average LED current) =	0.220 Ratio
	$\Delta I_{LED} =$	factor * $I_{LEDavg} =$	0.163 A
<b>2.) Determine SW pin Duty cycle, <math>D_{sw}</math></b>			
	$D_{sw} =$	$1 - \frac{V_{LED \times N} + V_D + V_{rsense}}{V_S - V_T + V_D} =$	0.227 Ratio
<b>3.) Estimated typical operating frequency</b>			
	$f =$	$\frac{D_{sw}}{\text{factor} * L} * \frac{(V_{LED \times N} + V_D + V_{rsense})}{I_{LEDavg}} =$	195 kHz

The inductance, L can be made the subject of equation in step 3; given the desired switching frequency, f.

[www.infineon.com](http://www.infineon.com)