

ASSEMBLY - TOP VIEW

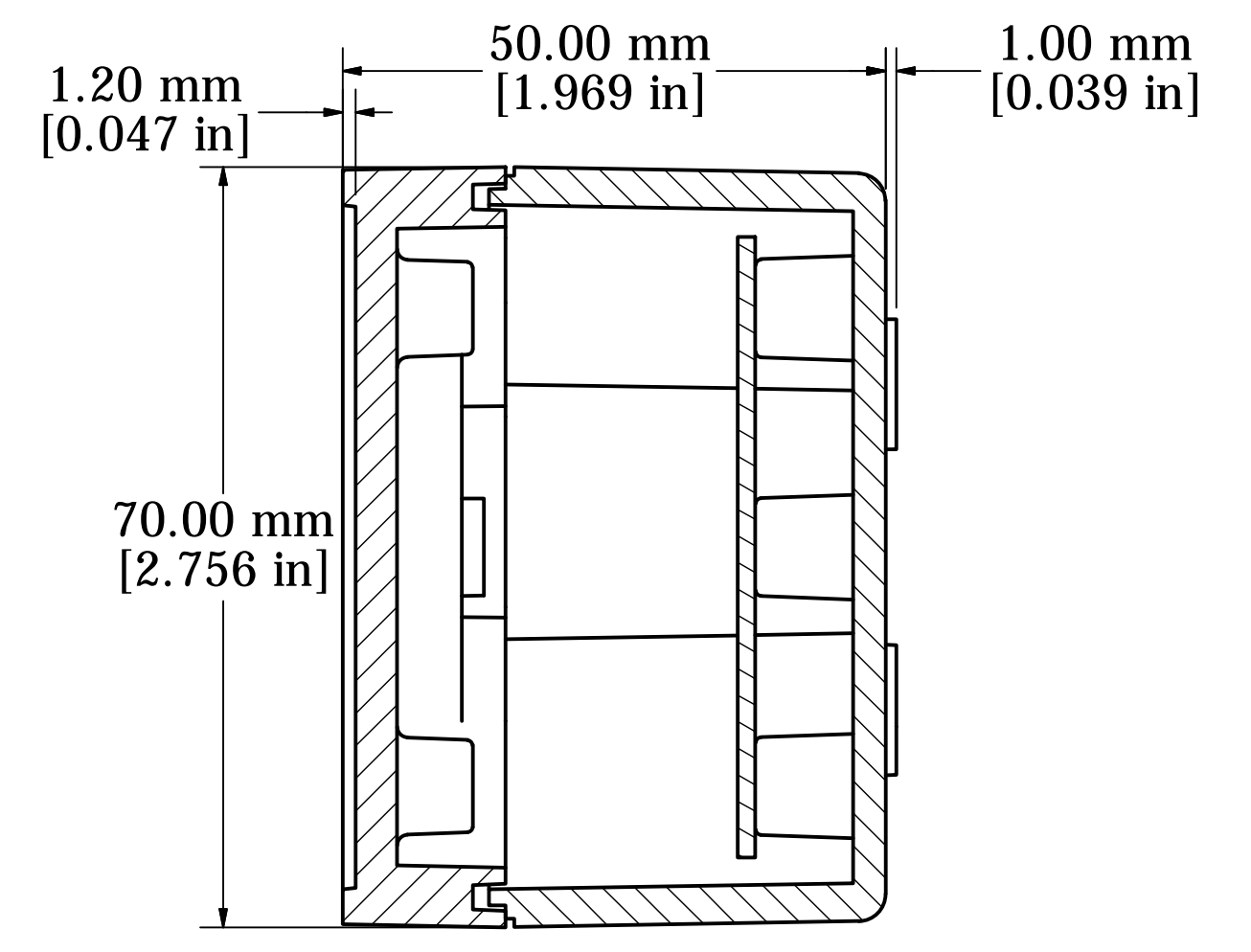

SECTION A-A

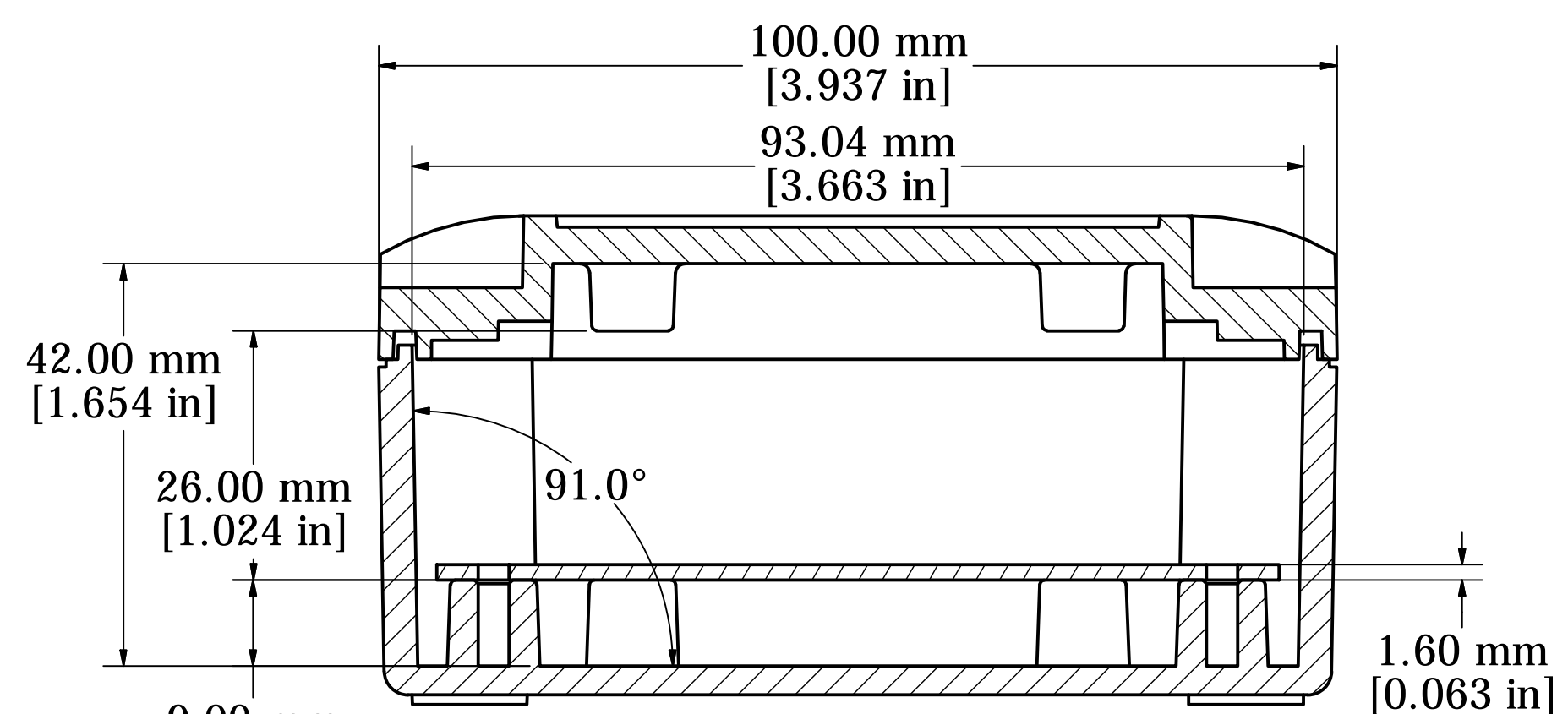
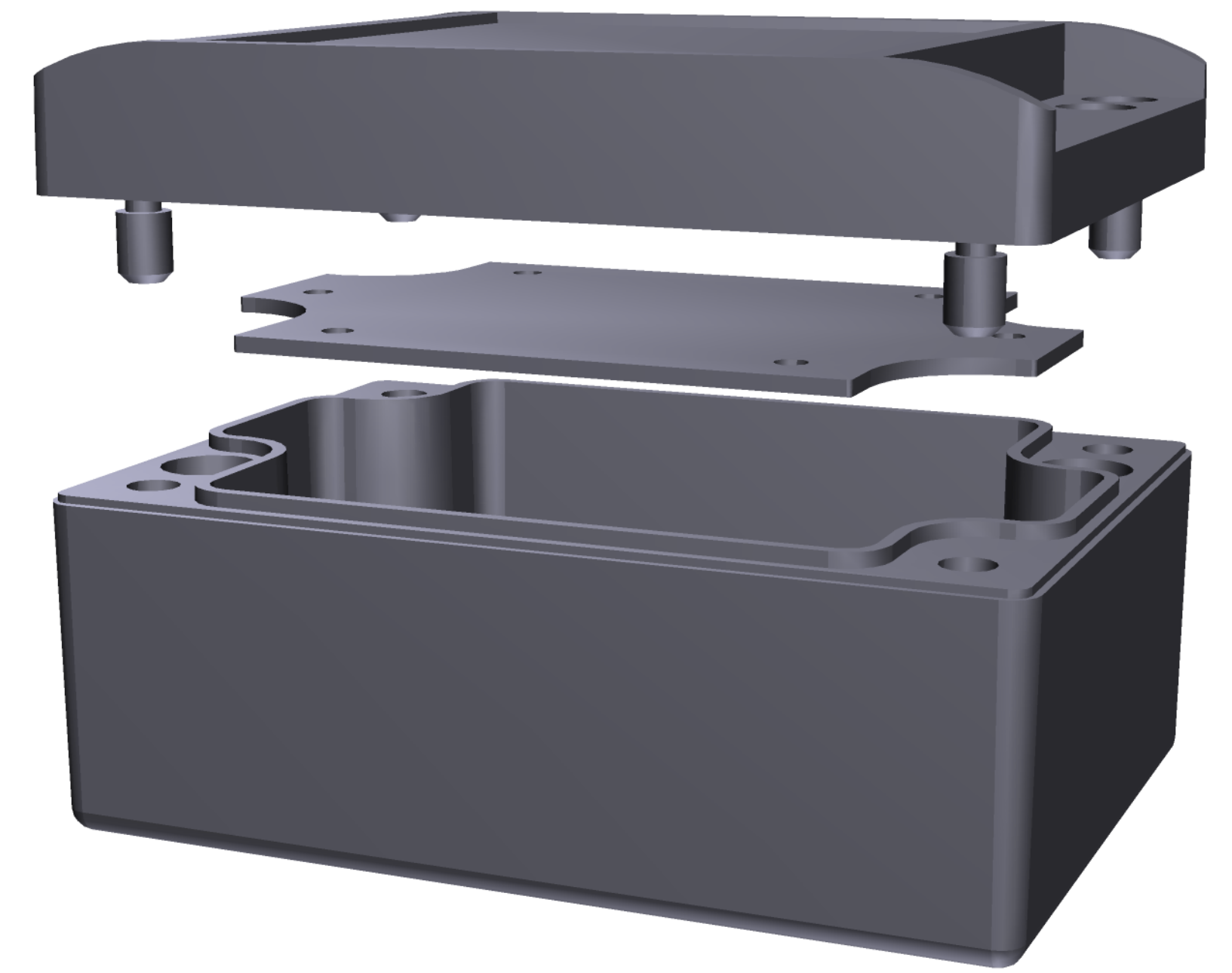

SECTION B-B

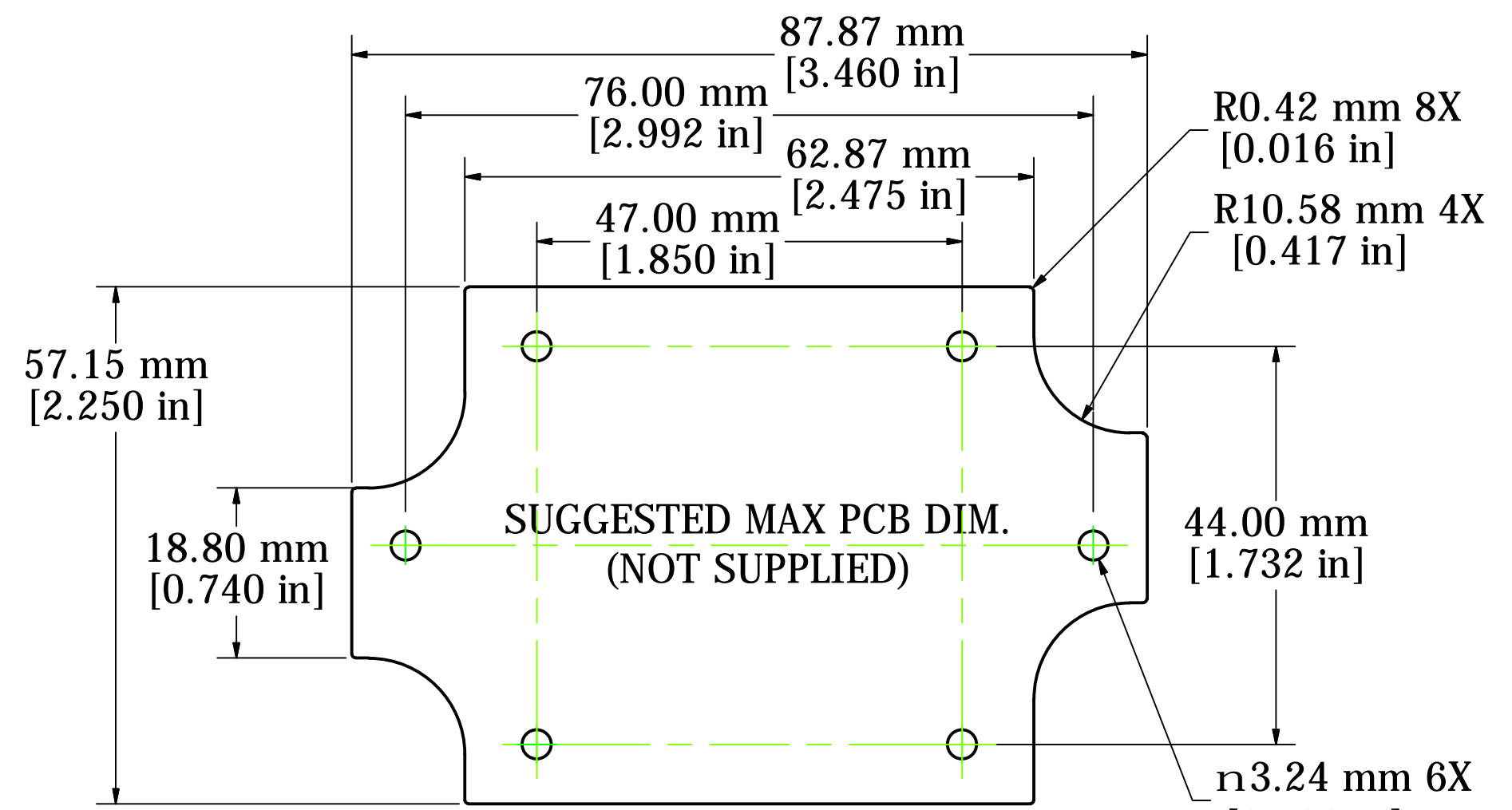

PCB

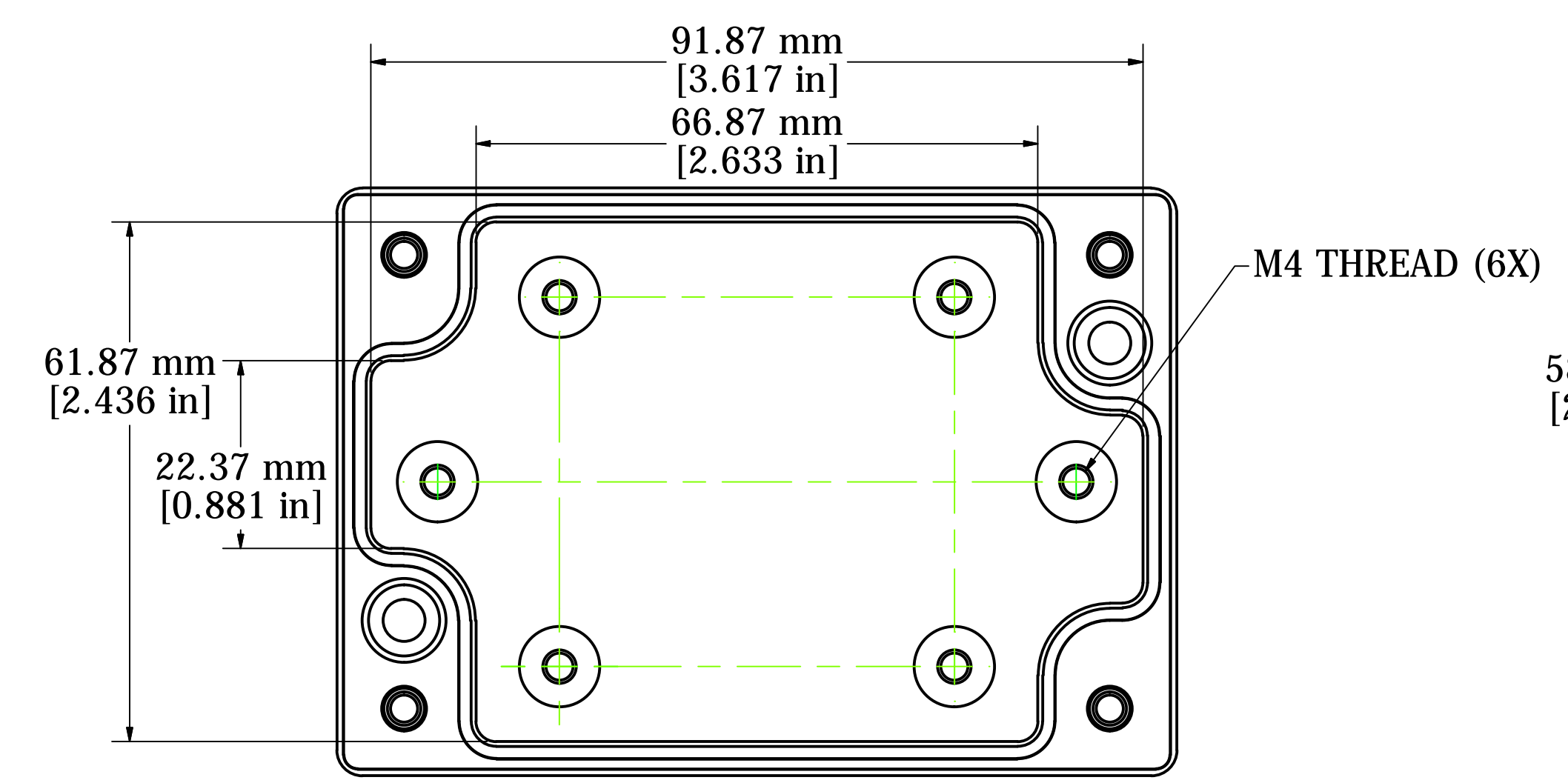

BOX - INSIDE VIEW

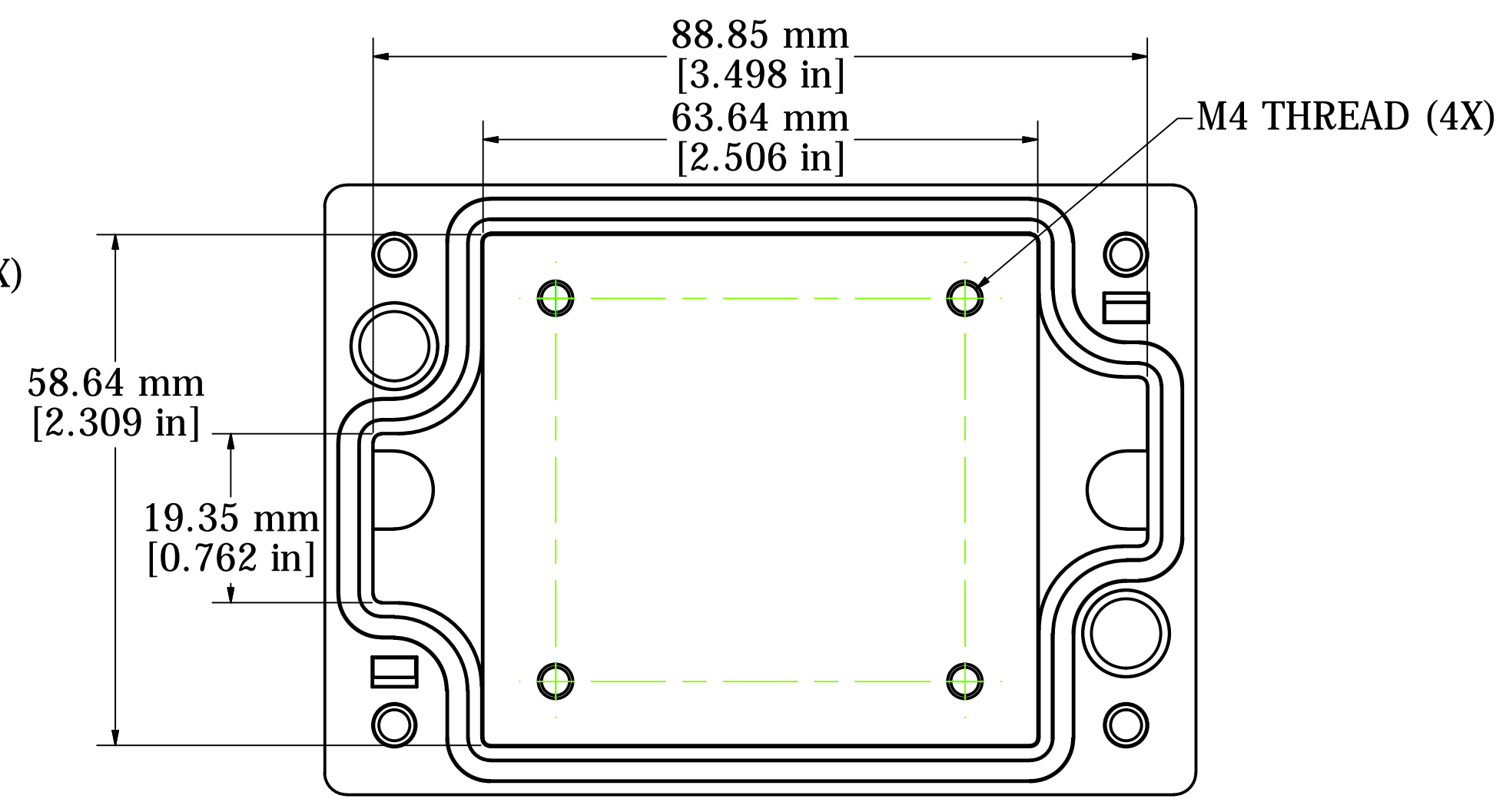

LID - INSIDE VIEW

Enclosures can be Factory Modified (Milling, Drilling, Printing etc.)
Contact Factory mjm@hammondmfg.com for quotes
Solid models of this enclosure available in STEP or IGES.

NOTE
Purchased Assembly includes:
Top and Bottom Cover (Die-cast aluminum GAl Si 12/ DN1725)
4 Captive Stainless Steel Screws.
Standard Powder Coated (Silky Grey RAL 7040)
PCM Design Covers



**HAMMOND
MANUFACTURING™**

R191-070-000

www.hammondmfg.com