

GlobTek, Inc. www.globtek.com 186 Veterans Drive, Northvale, NJ 07647 Tel. (201) 784-1000 Fax (201) 784-0111	Drawing Title: GTM86100-1005-W2E-USB, ITE / Medical Power Supply, Efficiency Level: VI, Case Color/Style: GlobTek Black, Wall Plug-in, AC/DC Switching Adapter with USB Power Supply AC Adaptor, Input Rating: 100-240V~, 50-60Hz, Euro Plug Fixed, Output Rating: 10W, 5V@2A, Output Configuration: N/A mm, N/A/4 Cond, N/A, Type "A" USB "JACK", integral to power supply enclosure, Ferrite: None, N/A, GT Cord # C0132, Pin Out: USB Jack, Pin 1: (+), Pin 2: AND Pin 3: SHORT, Pin 4: Com, Blades/Input Cord: Fixed Blades Europlug 2 pins, Class II; P/N: Q-EU(R), Approvals: Ukraine S-Mark IEC/EN 60601-1 EAC CE China RoHS Double Insulation Level VI RoHS VCCI WEEE	
	Model No. GTM86100-1005-W2E-USB	
	Part No./Ordering No. WR9MA2000USBMF(R6B)	Rev B

## REVISION HISTORY

REV	DESCRIPTION	SUB	DATE	APPROVED
B	Update pinout to Pin 1: (+), Pin 2: AND Pin 3: Shorted, Pin 4: Com	QA	02/23/2018	QA
A1	Update approval: adding S-Mark	rchiu	12/05/2017	QA
A	Initial release.	rchiu	07/11/2017	QA

In Addition to GlobTek Inc.'s renewed ISO9001:2008 - Quality Management System Certification, GlobTek Inc. is now certified to:

ISO13485:2003 - Medical Devices Quality Management System Certification  
 ISO14001:2004 - Environmental Management System Certification

ISO Certificates are available online at <http://www.globtek.com/iso-certificates/>

### Customer Approval of Specification:

Please approve, sign and send back to GlobTek so we can complete order processing.

A delay in receipt of this form will delay delivery schedule.

Company Name:

Customer P/N:

Quote Number:

Date:

Authorized Representative Name:

Authorized Representative Signature:

The acceptance of this specification and use of the product described in this document indicates the acceptance and binding of the customer to Globtek terms and conditions, which supersede all other agreements, terms, and conditions (<http://en.globtek.com/terms-and-conditions/>).

### Footnote:

GlobTek Inc. will not be liable for the safety and performance of these power supplies if unauthorized access and repair occurs. End user should consult applicable UL, CSA or EN standards for proper installation instruction.

### Limitation of Use:

GlobTek product are not authorized for use as mission critical components in life support hazardous environment, nuclear or aircraft applications without prior written approval from the CEO of GlobTek Inc.

Contents of this document are subject to change without prior notice.

GTM86100-1005-W2E-USB, 10W, 5V@2A, Wall Plug-in, AC/DC Switching Adapter with USB Power Supply AC Adaptor

PROPRIETARY INFORMATION

PROPRIETARY OF GLOBTEK, INC. ANY REPRODUCTION, DISCLOSURE OR USE OF THIS DRAWING, IN WHOLE OR IN PART, IS HEREBY PROHIBITED EXCEPT AS SPECIFIED IN WRITING BY GLOBTEK, INC.

quest /08/20/2018 7:42:40 AM

GlobTek, Inc. www.globtek.com 186 Veterans Drive, Northvale, NJ 07647 Tel. (201) 784-1000 Fax (201) 784-0111	Drawing Title: GTM86100-1005-W2E-USB, ITE / Medical Power Supply, Efficiency Level: VI, Case Color/Style: GlobTek Black, Wall Plug-in, AC/DC Switching Adapter with USB Power Supply AC Adaptor, Input Rating: 100-240V~, 50-60Hz, Euro Plug Fixed , Output Rating: 10W, 5V@2A, Output Configuration: N/A mm, N/A/4 Cond, N/A, Type "A" USB "JACK", integral to power supply enclosure, Ferrite: None, N/A, GT Cord # C0132, Pin Out: USB Jack, Pin 1: (+), Pin 2: AND Pin 3: SHORT, Pin 4: Com, Blades/Input Cord: Fixed Blades Europlug 2 pins, Class II; P/N: Q-EU(R), Approvals: Ukraine S-Mark IEC/EN 60601-1 EAC CE China RoHS Double Insulation Level VI RoHS VCCI WEEE	
	Model No. GTM86100-1005-W2E-USB	
	Part No./Ordering No. WR9MA2000USBMF(R6B)	Rev B

## POWER SUPPLY INFORMATION

TYPE: Wall Plug-in  
TECHNOLOGY: AC/DC Switching Adapter with USB Power Supply AC Adaptor  
CASE COLOR: GlobTek Black  
NAMEPLATE RATED INPUT: 100-240V~, 50-60Hz, 0.3A  
INPUT CONFIG: Euro Plug Fixed  
WATTS: 10.0  
VOLTS OUT: 5  
CURRENT OUT (Amps): 2  
BLADE/CORD INCLUDED: FBEU:  
BLADE/CORD INSTALLED: FBEU:  
GROUNDING CONFIGURATION (F1) Class II / Double Insulated  
EFFICIENCY LEVEL: VI  
OUTPUT CONFIGURATION N/A mm, N/A/4 Cond, N/A, Type "A" USB "JACK", integral to power supply enclosure, Ferrite: None, N/A, GT Cord # C0132  
CONNECTOR PIN OUT: USB Jack, Pin 1: (+), Pin 2: AND Pin 3: SHORT, Pin 4: Com  
LABEL SPECS: Standard GT,L-1186  
PACK SPEC: Standard with USB Jack, Individually Box

Notes/Modifications/Customizations (notes in this section supersede the values shown in the standard spec):

Without Green Indicator LED

DIMENSIONS ARE IN MM UNLESS SPECIFIED OTHERWISE.

GlobTek, Inc. www.globtek.com 186 Veterans Drive, Northvale, NJ 07647 Tel. (201) 784-1000 Fax (201) 784-0111	Drawing Title: GTM86100-1005-W2E-USB, ITE / Medical Power Supply, Efficiency Level: VI, Case Color/Style: GlobTek Black, Wall Plug-in, AC/DC Switching Adapter with USB Power Supply AC Adaptor, Input Rating: 100-240V~, 50-60Hz, Euro Plug Fixed , Output Rating: 10W, 5V@2A, Output Configuration: N/A mm, N/A/4 Cond, N/A, Type "A" USB "JACK", integral to power supply enclosure, Ferrite: None, N/A, GT Cord # C0132, Pin Out: USB Jack, Pin 1: (+), Pin 2: AND Pin 3: SHORT, Pin 4: Com, Blades/Input Cord: Fixed Blades Europlug 2 pins, Class II; P/N: Q-EU(R), Approvals: Ukraine S-Mark IEC/EN 60601-1 EAC CE China RoHS Double Insulation Level VI RoHS VCCI WEEE	
	Model No. GTM86100-1005-W2E-USB	
	Part No./Ordering No. WR9MA2000USBMF(R6B)	Rev B

## ELECTRICAL SPECIFICATIONS

01. Input Voltage: Specified 90-264 Vac, Nameplate rated: 100-240Vac
02. Input Frequency: Specified 47-63 Hz, Nameplate rated 50/60Hz
03. Output Regulation: +/- 5% measured at the end of a 1 meter USB cordset employing #20 Gauge conductors
04. Line Voltage Regulation: +/- 1% typical measured at the end of a 1 meter USB cordset employing #20 Gauge conductors
05. Output Ripple (Vp-p): 100 mVpp max, measured at the end of a 1 meter USB cordset employing #20 Gauge conductors. Measured at 20 MHz bandwidth with 0.1 uf ceramic capacitor in parallel with a low impedance 47 uf electrolytic capacitor connected at the end of the output connector.
06. Hold-up Time: 5 mS minimum
07. Inrush Current: 30A maximum @ 230Vac input
08. Energy Efficiency: Complies to Efficiency Level VI and ErP **European** Commission's Ecodesign Directive (2005/32/EC) / CoC Tier 2 Compliant

### B) PROTECTION

01. Over-current protection: 4A maximum with auto-recovery function
02. Over-voltage protection: 10VDC maximum with zener clamp
03. Short-circuit protection: The adapter shall not be damaged by short the DC output to Ground.

### C) SAFETY

01. Dielectric Withstand Voltage: Primary To Secondary: 4000VAC or 5656VDC for 3 seconds
02. Leakage Current: 50uA maximum, at nominal 240Vac input voltage
03. ESD Immunity per EN61000-4-2, ±8 kV contact, ±15 kV air, Perf Criteria A Standard.

### D) OTHER:

01. MTBF: 300,000 Hours @ 25°C ambient temperature
02. Operating Temperature: 0°C to 50°C ambient temperature
03. Operating Humidity: 20 ~ 85 % RH. non-condensing
05. Storage Temperature: -20°C to 60°C
06. Storage Humidity: 5 ~ 95 % RH. non-condensing
07. Cooling: Natural convection cooling
08. RoHS 2: Complies with EU 2011/65/EU China SJ/T 11364-2014

### E) ENCLOSURE

01. Housing: High impact plastic, 94V0 polycarbonate, non-vented
02. Markings: Label and/or Pad Printed and/or Molded in the case

### F) OPTIONS:

01. Green Power On Indicator LED
02. NEMA 1-15P or European Schuko 7-16 AC Plug Configuration
03. Increased DC Output Voltage (up to 5.4V) to allow for long output cables
04. Special International Safety Approvals
05. Housing Color, special markings

GlobTek, Inc.  
www.globtek.com  
186 Veterans Drive,  
Northvale, NJ 07647  
Tel. (201) 784-1000  
Fax (201) 784-0111

Drawing Title: GTM86100-1005-W2E-USB, ITE / Medical Power Supply, Efficiency Level: VI, Case Color/Style: GlobTek Black, Wall Plug-in, AC/DC Switching Adapter with USB Power Supply AC Adaptor, Input Rating: 100-240V~, 50-60Hz, Euro Plug Fixed, Output Rating: 10W, 5V@2A, Output Configuration: N/A mm, N/A/4 Cond, N/A, Type "A" USB "JACK", integral to power supply enclosure, Ferrite: None, N/A, GT Cord # C0132, Pin Out: USB Jack, Pin 1: (+), Pin 2: AND Pin 3: SHORT, Pin 4: Com, Blades/Input Cord: Fixed Blades Europlug 2 pins, Class II; P/N: Q-EU(R), Approvals: Ukraine S-Mark IEC/EN 60601-1 EAC CE China RoHS Double Insulation Level VI RoHS VCCI WEEE

Model No. GTM86100-1005-W2E-USB

Part No./Ordering No. WR9MA2000USBMF(R6B)

Rev B

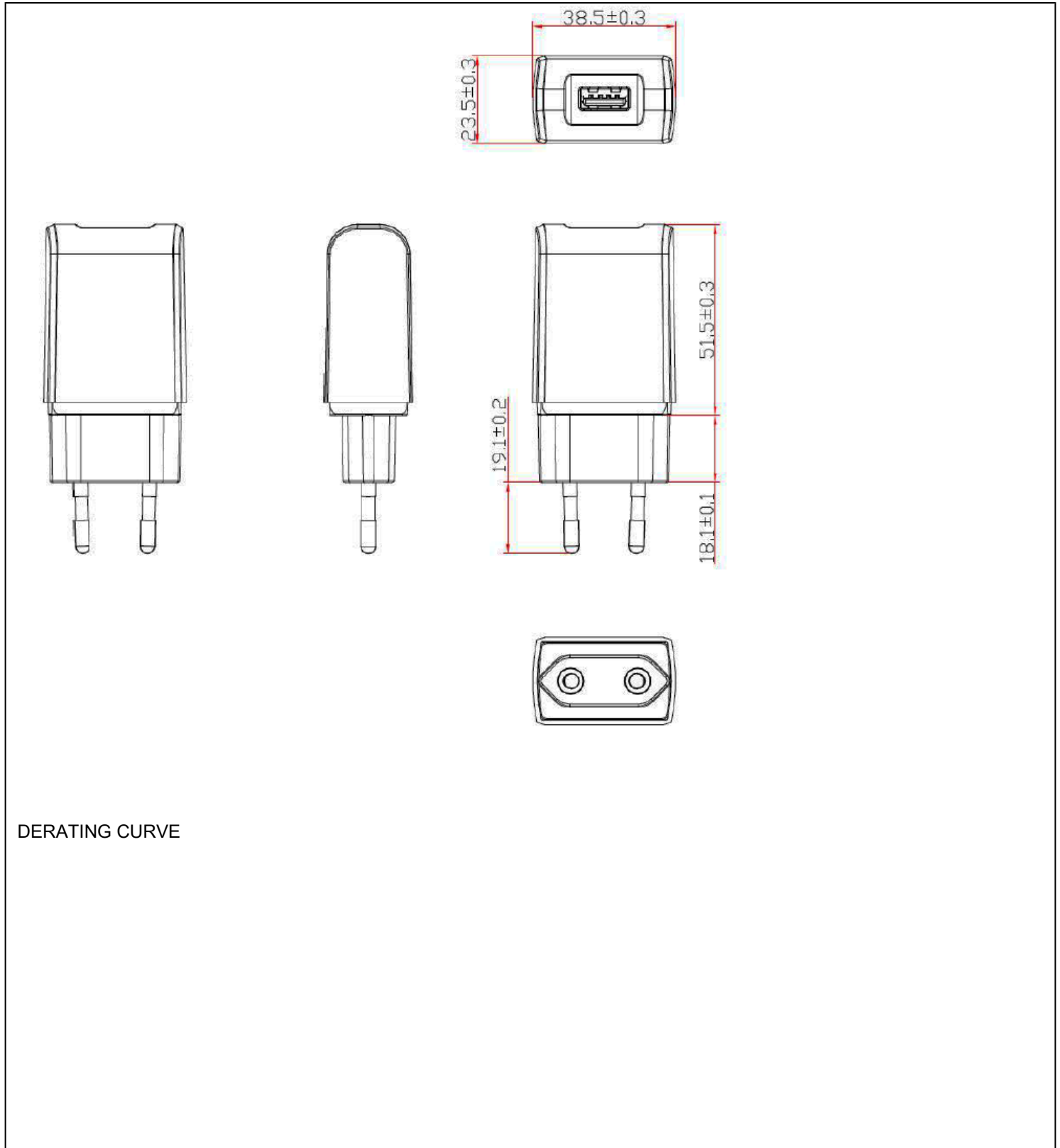

DERATING CURVE

GlobTek, Inc.  
 www.globtek.com  
 186 Veterans Drive,  
 Northvale, NJ 07647  
 Tel. (201) 784-1000  
 Fax (201) 784-0111

Drawing Title: GTM86100-1005-W2E-USB, ITE / Medical Power Supply, Efficiency Level: VI, Case Color/Style: GlobTek Black, Wall Plug-in, AC/DC Switching Adapter with USB Power Supply AC Adaptor, Input Rating: 100-240V~, 50-60Hz, Euro Plug Fixed, Output Rating: 10W, 5V@2A, Output Configuration: N/A mm, N/A/4 Cond, N/A, Type "A" USB "JACK", integral to power supply enclosure, Ferrite: None, N/A, GT Cord # C0132, Pin Out: USB Jack, Pin 1: (+), Pin 2: AND Pin 3: SHORT, Pin 4: Com, Blades/Input Cord: Fixed Blades Europlug 2 pins, Class II; P/N: Q-EU(R), Approvals: Ukraine S-Mark IEC/EN 60601-1 EAC CE China RoHS Double Insulation Level VI RoHS VCCI WEEE

Model No. GTM86100-1005-W2E-USB

Part No./Ordering No. WR9MA2000USBMF(R6B)

Rev B

### Typical External Power Supply Derating Curve

(For Efficiency Level V and Efficiency Level VI Products)

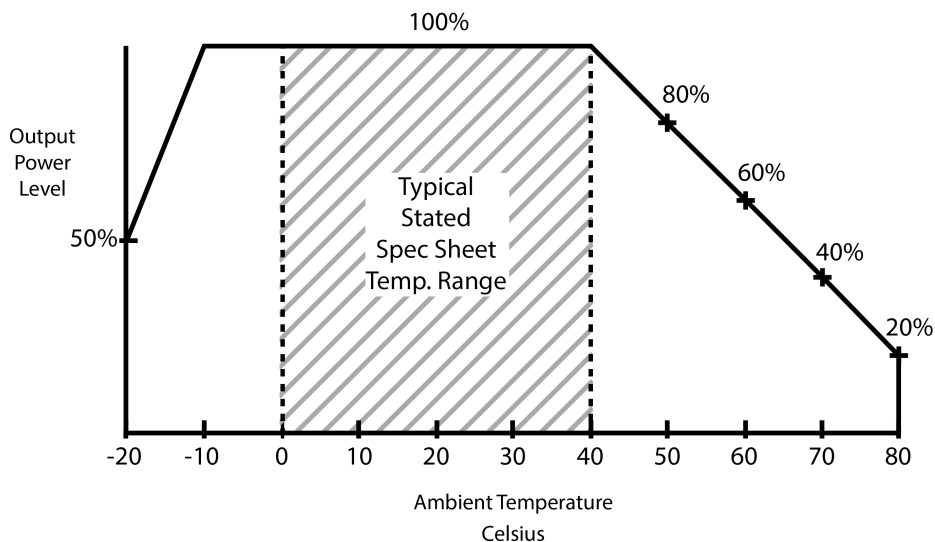

GlobTek, Inc. www.globtek.com 186 Veterans Drive, Northvale, NJ 07647 Tel. (201) 784-1000 Fax (201) 784-0111	Drawing Title: GTM86100-1005-W2E-USB, ITE / Medical Power Supply, Efficiency Level: VI, Case Color/Style: GlobTek Black, Wall Plug-in, AC/DC Switching Adapter with USB Power Supply AC Adaptor, Input Rating: 100-240V~, 50-60Hz, Euro Plug Fixed, Output Rating: 10W, 5V@2A, Output Configuration: N/A mm, N/A/4 Cond, N/A, Type "A" USB "JACK", integral to power supply enclosure, Ferrite: None, N/A, GT Cord # C0132, Pin Out: USB Jack, Pin 1: (+), Pin 2: AND Pin 3: SHORT, Pin 4: Com, Blades/Input Cord: Fixed Blades Europlug 2 pins, Class II; P/N: Q-EU(R), Approvals: Ukraine S-Mark IEC/EN 60601-1 EAC CE China RoHS Double Insulation Level VI RoHS VCCI WEEE	
	Model No. GTM86100-1005-W2E-USB	
	Part No./Ordering No. WR9MA2000USBMF(R6B)	Rev B

## INPUT CONFIGURATION

Grounding Configuration:

Blades/Cord Included: FBEU:

Blades/Cord Installed: FBEU:

European CEE 7/16 configuration: Europlug 2 PIN

The prongs of the Europlug are 19 mm long. They consist of a 9 mm long conductive tip of 4 mm diameter with a rounded ending, followed by a 10 mm long flexible insulated shaft of not more than 3.8 mm diameter. The two prongs are not exactly parallel and converge slightly; their centres are 19 mm apart at the tip and 18.6 mm apart at the base. The elasticity of the converging prongs provides sufficient contact force for the Europlug's current rating with a variety of socket-hole arrangements. The entire plug is 35.3 mm wide and 13.7 mm high, and must not exceed these dimensions within 18 mm behind its front plane (this allows for the recesses on many European socket types). The left and right side of the plug are formed by surfaces that are at 45° relative to the horizontal plan.

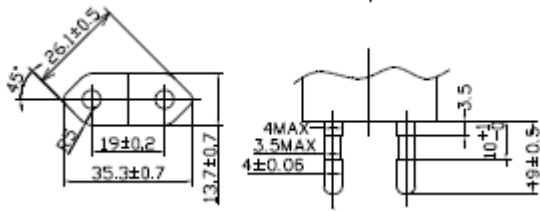

GlobTek, Inc. www.globtek.com 186 Veterans Drive, Northvale, NJ 07647 Tel. (201) 784-1000 Fax (201) 784-0111	Drawing Title: GTM86100-1005-W2E-USB, ITE / Medical Power Supply, Efficiency Level: VI, Case Color/Style: GlobTek Black, Wall Plug-in, AC/DC Switching Adapter with USB Power Supply AC Adaptor, Input Rating: 100-240V~, 50-60Hz, Euro Plug Fixed , Output Rating: 10W, 5V@2A, Output Configuration: N/A mm, N/A/4 Cond, N/A, Type "A" USB "JACK", integral to power supply enclosure, Ferrite: None, N/A, GT Cord # C0132, Pin Out: USB Jack, Pin 1: (+), Pin 2: AND Pin 3: SHORT, Pin 4: Com, Blades/Input Cord: Fixed Blades Europlug 2 pins, Class II; P/N: Q-EU(R), Approvals: Ukraine S-Mark IEC/EN 60601-1 EAC CE China RoHS Double Insulation Level VI RoHS VCCI WEEE	
	Model No. GTM86100-1005-W2E-USB	
	Part No./Ordering No. WR9MA2000USBMF(R6B)	Rev B

**OUTPUT CORD AND CONNECTOR: USBMT/C0132**

ACTUAL CONNECTORS, OVERMOLDS, FERRITES MAY VARY SLIGHTLY FROM THE PICTURE BELOW

CABLE TYPE	N/A
CABLE LENGTH (mm)	N/A
CABLE TOLERANCE (mm)	N/A
WIRE GAUGE (AWG)	N/A
CONDUCTORS	4
HANK DIMENSION (mm)	N/A
CABLE / CONNECTOR OVERMOLD COLOR	N/A
FERRITE TYPE / DIMENSION	None
FERRITE # OF TURNS ( <a href="#">Definition</a> )	N/A
FERRITE DIMENSION FROM STRAIN RELIEF	N/A
FERRITE DIMENSION FROM PLUG	N/A
PLUG TYPE	Type "A" USB "JACK", integral to power supply enclosure
OVER MOLD ORIENTATION	PCB Mount Connector
CONNECTOR PIN OUT:	USB Jack, Pin 1: (+), Pin 2: AND Pin 3: SHORT, Pin 4: Com
ADDITIONAL REQUIREMENTS	 

Front View

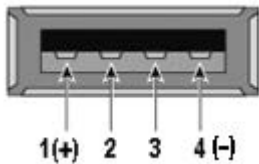

ADDITIONAL OUTPUT PLUG OPTIONS ARE AVAILABLE AT <http://www.globtek.com/connectors/>  
STANDARD PLUGS AND CONNECTORS CAN BE SEEN ONLINE AT <http://www.globtek.com/connectors/>

GlobTek, Inc. www.globtek.com 186 Veterans Drive, Northvale, NJ 07647 Tel. (201) 784-1000 Fax (201) 784-0111	Drawing Title: GTM86100-1005-W2E-USB, ITE / Medical Power Supply, Efficiency Level: VI, Case Color/Style: GlobTek Black, Wall Plug-in, AC/DC Switching Adapter with USB Power Supply AC Adaptor, Input Rating: 100-240V~, 50-60Hz, Euro Plug Fixed, Output Rating: 10W, 5V@2A, Output Configuration: N/A mm, N/A/4 Cond, N/A, Type "A" USB "JACK", integral to power supply enclosure, Ferrite: None, N/A, GT Cord # C0132, Pin Out: USB Jack, Pin 1: (+), Pin 2: AND Pin 3: SHORT, Pin 4: Com, Blades/Input Cord: Fixed Blades Europlug 2 pins, Class II; P/N: Q-EU(R), Approvals: Ukraine S-Mark IEC/EN 60601-1 EAC CE China RoHS Double Insulation Level VI RoHS VCCI WEEE	
	Model No. GTM86100-1005-W2E-USB	
	Part No./Ordering No. WR9MA2000USBMF(R6B)	Rev B

**LABEL:L-1186**

**LABEL P/N:** Standard GT  
**MATERIAL:** Flat Thermal Transfer, Imprintable, Polyester Label and/or Pad Printed and/or Molded, and/or Laser Engraved in the case  
**BACKGROUND COLOR:** Black if housing is Black, White or Silver if housing is White or Gray.  
**TEXT COLOR:** White or Silver if label is Black Background for Black housing. Black if label is White or Silver background and Housing is White or Gray  
**LABEL WIDTH (mm):** 37.0  
**LABEL HEIGHT (mm):** 19.0

Below is the minimum information which will appear on the label. NOTE: in the logo area additional/actual positioning of symbols and text is subjected to change as per agency updates/requirements or additional model approvals become available.  
 Regulatory certifications/label markings may be in logo area on the label or molded into the case housing outside the label area.  
 Information will be shown via label and/or pad printed and/or molded and/or laser engraved in the case. \* Date code markings at GlobTek option.

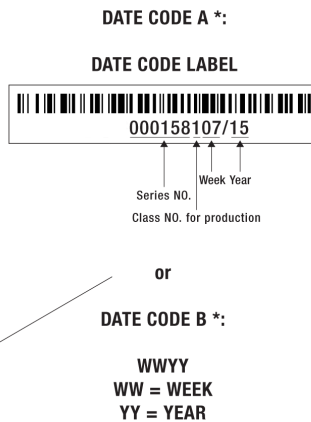

A=ITE / Medical Power Supply  
 B=P/N: (料号) WR9MA2000USBMF(R6B)  
 C=Model (型号) GTM86100-1005-W2E-USB  
 D=Input (输入) 100-240V~, 50-60Hz, 0.3A  
 E=Output (输出) 5 V  $\equiv$  2 A, 10.0W

- |   |   |
|---|---|
| AGENCY ONLINE DOCUMENTS                         | <a href="http://www.globtek.info/certs/GTM86100/">http://www.globtek.info/certs/GTM86100/</a>   |
| CE EC-Declaration for Medical                   | <a href="http://www.globtek.com/pdf/ec_declaration/a0Oa000000FgEIEAJ">http://www.globtek.com/pdf/ec_declaration/a0Oa000000FgEIEAJ</a> |
| CE EC-Declaration for Industrial/Commercial/ITE | <a href="http://www.globtek.com/pdf/ec_declaration/a0Oa000000FgEIEAJ">http://www.globtek.com/pdf/ec_declaration/a0Oa000000FgEIEAJ</a> |
| RoHS/RoHS2 Declaration                          | <a href="http://www.globtek.com/pdf/rohs_cert/01ta0000008APrLAAW">http://www.globtek.com/pdf/rohs_cert/01ta0000008APrLAAW</a>         |
| REACH Declaration                               | <a href="http://www.globtek.com/pdf/iso_certificates/REACH.pdf">http://www.globtek.com/pdf/iso_certificates/REACH.pdf</a>             |



GlobTek, Inc. www.globtek.com 186 Veterans Drive, Northvale, NJ 07647 Tel. (201) 784-1000 Fax (201) 784-0111	Drawing Title: GTM86100-1005-W2E-USB, ITE / Medical Power Supply, Efficiency Level: VI, Case Color/Style: GlobTek Black, Wall Plug-in, AC/DC Switching Adapter with USB Power Supply AC Adaptor, Input Rating: 100-240V~, 50-60Hz, Euro Plug Fixed , Output Rating: 10W, 5V@2A, Output Configuration: N/A mm, N/A/4 Cond, N/A, Type "A" USB "JACK", integral to power supply enclosure, Ferrite: None, N/A, GT Cord # C0132, Pin Out: USB Jack, Pin 1: (+), Pin 2: AND Pin 3: SHORT, Pin 4: Com, Blades/Input Cord: Fixed Blades Europlug 2 pins, Class II; P/N: Q-EU(R), Approvals: Ukraine S-Mark IEC/EN 60601-1 EAC CE China RoHS Double Insulation Level VI RoHS VCCI WEEE	
	Model No. GTM86100-1005-W2E-USB	
	Part No./Ordering No. WR9MA2000USBMF(R6B)	Rev B

Conflict Minerals Declaration

<http://www.globtek.com/pdf/conflict-minerals.pdf>

IPXY rating is based on 3rd party testing and customers should check suitability and test system level IPXY rating before ordering.

## Regulatory Certifications/Label Markings

LATEST PRODUCT/MODEL CERTIFICATIONS: <http://en.globtek.com/datasheet/id/a0Oa000000FigEI>

AGENCY ONLINE DOCUMENTS: <http://www.globtek.info/certs/GTM86100/>

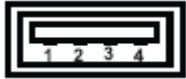

USB Jack, Pin 1: (+), Pin 2: AND Pin 3: SHORT, Pin 4: Com

GlobTek, Inc. www.globtek.com 186 Veterans Drive, Northvale, NJ 07647 Tel. (201) 784-1000 Fax (201) 784-0111	Drawing Title: GTM86100-1005-W2E-USB, ITE / Medical Power Supply, Efficiency Level: VI, Case Color/Style: GlobTek Black, Wall Plug-in, AC/DC Switching Adapter with USB Power Supply AC Adaptor, Input Rating: 100-240V~, 50-60Hz, Euro Plug Fixed , Output Rating: 10W, 5V@2A, Output Configuration: N/A mm, N/A/4 Cond, N/A, Type "A" USB "JACK", integral to power supply enclosure, Ferrite: None, N/A, GT Cord # C0132, Pin Out: USB Jack, Pin 1: (+), Pin 2: AND Pin 3: SHORT, Pin 4: Com, Blades/Input Cord: Fixed Blades Europlug 2 pins, Class II; P/N: Q-EU(R), Approvals: Ukraine S-Mark IEC/EN 60601-1 EAC CE China RoHS Double Insulation Level VI RoHS VCCI WEEE	
	Model No. GTM86100-1005-W2E-USB	
	Part No./Ordering No. WR9MA2000USBMF(R6B)	Rev B

**PACKAGING**

Packing Spec P/N: Standard with USB Jack, Individually Box

Box Qty: 300

Gift Box Size (mm): 43(L)\*30(W)\*95

Gift Box Color: White

Master Carton Size (mm): 485\*335\*305

Master GW (Kg): 12.0 kg

BLADES INCLUDED: FBEU:

BLADE/CORD INSTALLED: FBEU:

If specific packaging is required, this section must specify all requirements and note "no exceptions". If this section does not specify packaging, it is subject to change without notice at GlobTek's discretion

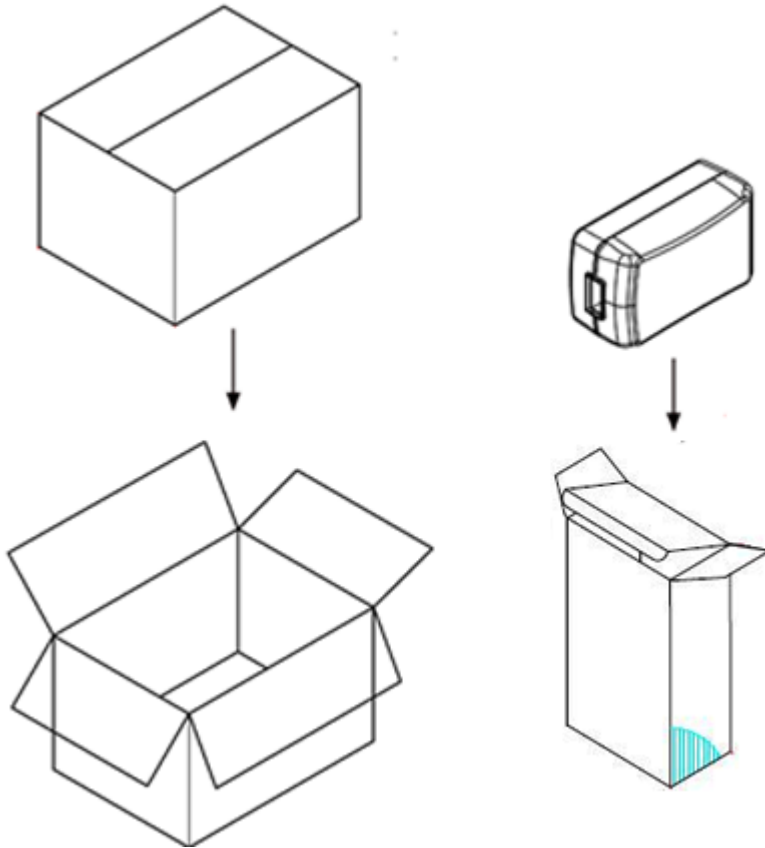

GlobTek, Inc. www.globtek.com 186 Veterans Drive, Northvale, NJ 07647 Tel. (201) 784-1000 Fax (201) 784-0111	Drawing Title: GTM86100-1005-W2E-USB, ITE / Medical Power Supply, Efficiency Level: VI, Case Color/Style: GlobTek Black, Wall Plug-in, AC/DC Switching Adapter with USB Power Supply AC Adaptor, Input Rating: 100-240V~, 50-60Hz, Euro Plug Fixed , Output Rating: 10W, 5V@2A, Output Configuration: N/A mm, N/A/4 Cond, N/A, Type "A" USB "JACK", integral to power supply enclosure, Ferrite: None, N/A, GT Cord # C0132, Pin Out: USB Jack, Pin 1: (+), Pin 2: AND Pin 3: SHORT, Pin 4: Com, Blades/Input Cord: Fixed Blades Europlug 2 pins, Class II; P/N: Q-EU(R), Approvals: Ukraine S-Mark IEC/EN 60601-1 EAC CE China RoHS Double Insulation Level VI RoHS VCCI WEEE	
	Model No. GTM86100-1005-W2E-USB	
	Part No./Ordering No. WR9MA2000USBMF(R6B)	Rev B

INSTRUCTION SHEET

N/A