



Military Temp, 18-Mbit (512K × 36)
Flow-Through SRAM (With ECC)

Features

- Supports 133 MHz bus operations
- 512K × 36 common I/O
- 3.3 V core power supply (V_{DD})
- 2.5 V or 3.3 V I/O supply (V_{DDQ})
- Fast clock-to-output time
 - 6.5 ns (133 MHz version)
- Provides high-performance 2-1-1 access rate
- User selectable burst counter supporting interleaved or linear burst sequences
- Separate processor and controller address strobes
- Synchronous self-timed write
- Asynchronous output enable
- Available in JEDEC-standard lead-free 100-pin TQFP
- ZZ sleep mode option
- On-chip error correction code (ECC) to reduce soft error rate (SER)
- Operates over military temperature range: -55 °C to +125 °C

Functional Description

The CY7C1381KVE33 is a 3.3 V, 512K × 36 synchronous flow-through SRAMs, designed to interface with high-speed microprocessors with minimum glue logic. The maximum access delay from clock rise is 6.5 ns (133 MHz version). A 2-bit on-chip counter captures the first address in a burst and increments the address automatically for the rest of the burst access. All synchronous inputs are gated by registers controlled by a positive edge-triggered clock input (CLK). The synchronous inputs include all addresses, all data inputs, address pipelining chip enable (CE₁), depth-expansion chip enables (CE₂ and CE₃), burst control inputs (ADSC, ADSP, and ADV), write enables (BW_x and BWE), and global write (GW). Asynchronous inputs include the output enable (OE) and the ZZ pin.

The CY7C1381KVE33 allows interleaved or linear burst sequences, selected by the MODE input pin. A HIGH selects an interleaved burst sequence, while a LOW selects a linear burst sequence. Burst accesses can be initiated with the processor address strobe (ADSP) or the cache controller address strobe (ADSC) inputs. Address advancement is controlled by the address advancement (ADV) input.

Addresses and chip enables are registered at the rising edge of the clock when the address strobe processor (ADSP) or address strobe controller (ADSC) are active. Subsequent burst addresses can be internally generated as controlled by the advance pin (ADV).

CY7C1381KVE33 operates from a +3.3 V core power supply while all outputs operate with a +2.5 V or +3.3 V supply. All inputs and outputs are JEDEC-standard and JESD8-5-compatible.

Selection Guide

Description		133 MHz	Unit
Maximum access time		6.5	ns
Maximum operating current	× 36	160	mA

Logic Block Diagram – CY7C1381KVE33

(512K × 36)

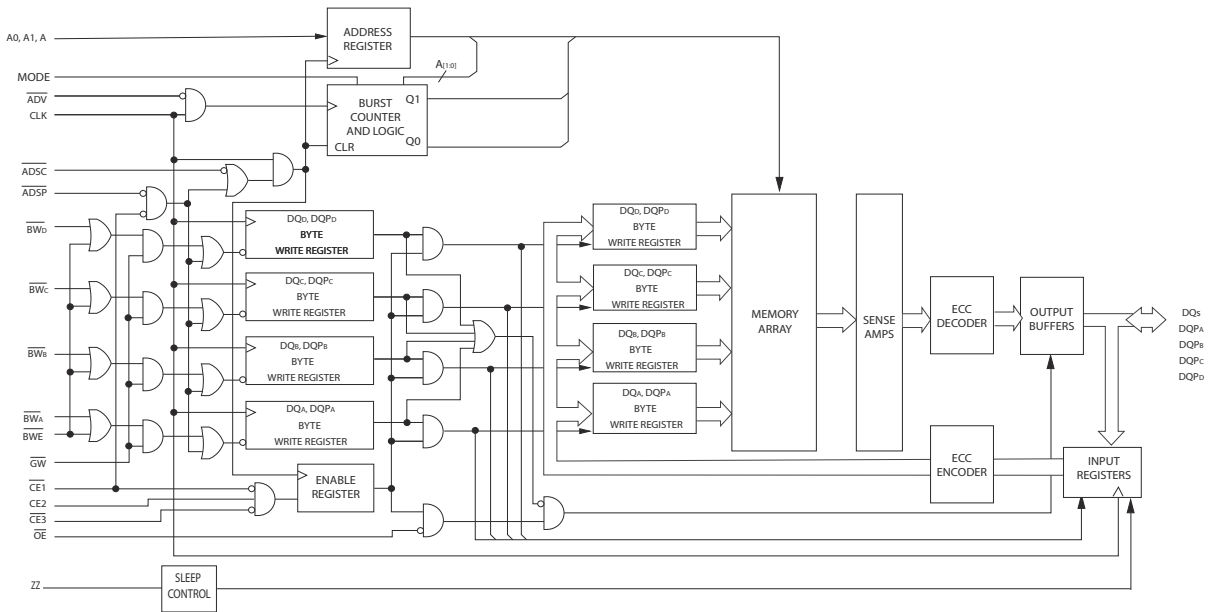

Contents

Pin Configurations	4	Thermal Resistance	12
Pin Definitions	5	AC Test Loads and Waveforms	12
Functional Overview	6	Switching Characteristics	13
Single Read Accesses	6	Timing Diagrams	14
Single Write Accesses Initiated by $\overline{\text{ADSP}}$	6	Ordering Information	18
Single Write Accesses Initiated by ADSC	6	Ordering Code Definitions	18
Burst Sequences	6	Package Diagrams	19
Sleep Mode	6	Acronyms	20
Interleaved Burst Address Table	7	Document Conventions	20
Linear Burst Address Table	7	Units of Measure	20
ZZ Mode Electrical Characteristics	7	Document History Page	21
Truth Table	8	Sales, Solutions, and Legal Information	22
Truth Table for Read/Write	9	Worldwide Sales and Design Support	22
Maximum Ratings	10	Products	22
Operating Range	10	PSoC® Solutions	22
Neutron Soft Error Immunity	10	Cypress Developer Community	22
Electrical Characteristics	10	Technical Support	22
Capacitance	12		

Pin Configurations

Figure 1. 100-pin TQFP (14 × 20 × 1.4 mm) Pinout (Three-Chip Enable)
CY7C1381KVE33 (512K × 36)

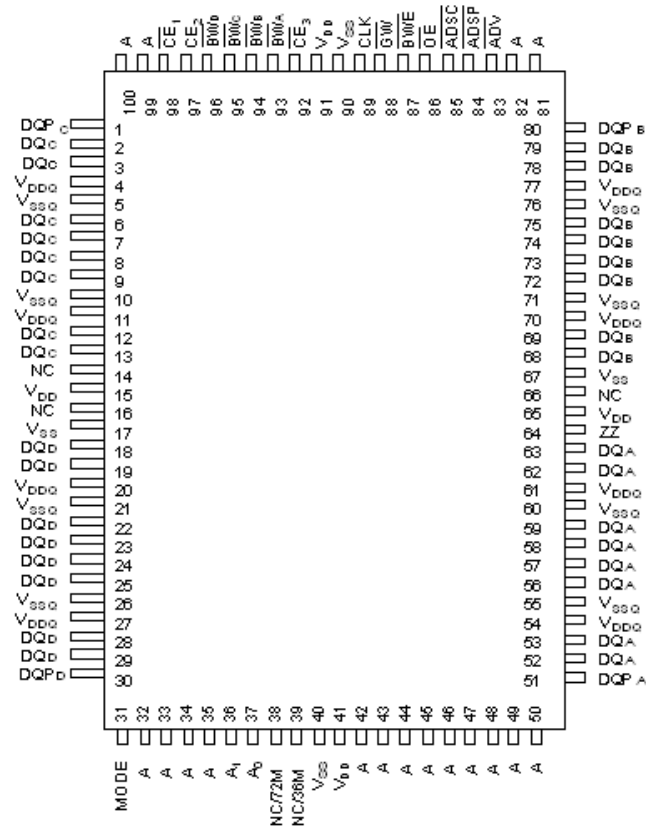

Pin Definitions

Name	I/O	Description
A_0, A_1, A	Input Synchronous	Address inputs used to select one of the address locations. Sampled at the rising edge of the CLK if ADSP or ADSC is active LOW, and $\overline{CE}_1, \overline{CE}_2,$ and \overline{CE}_3 are sampled active. $A_{[1:0]}$ feed the 2-bit counter.
$\overline{BW}_A, \overline{BW}_B,$ $\overline{BW}_C, \overline{BW}_D$	Input Synchronous	Byte write select inputs, active LOW. Qualified with \overline{BWE} to conduct byte writes to the SRAM. Sampled on the rising edge of CLK.
\overline{GW}	Input Synchronous	Global write enable input, active LOW. When asserted LOW on the rising edge of CLK, a global write is conducted (all bytes are written, regardless of the values on $\overline{BW}_{[A:D]}$ and BWE).
CLK	Input Clock	Clock input. Used to capture all synchronous inputs to the device. Also used to increment the burst counter when \overline{ADV} is asserted LOW, during a burst operation.
\overline{CE}_1	Input Synchronous	Chip enable 1 input, active LOW. Sampled on the rising edge of CLK. Used in conjunction with \overline{CE}_2 and \overline{CE}_3 to select or deselect the device. ADSP is ignored if \overline{CE}_1 is HIGH. \overline{CE}_1 is sampled only when a new external address is loaded.
\overline{CE}_2	Input Synchronous	Chip enable 2 input, active HIGH. Sampled on the rising edge of CLK. Used in conjunction with \overline{CE}_1 and \overline{CE}_3 to select or deselect the device. \overline{CE}_2 is sampled only when a new external address is loaded.
\overline{CE}_3	Input Synchronous	Chip enable 3 input, active LOW. Sampled on the rising edge of CLK. Used in conjunction with \overline{CE}_1 and \overline{CE}_2 to select or deselect the device. \overline{CE}_3 is sampled only when a new external address is loaded.
\overline{OE}	Input Asynchronous	Output enable, asynchronous input, active LOW. Controls the direction of the I/O pins. When LOW, the I/O pins behave as outputs. When deasserted HIGH, I/O pins are tristated, and act as input data pins. \overline{OE} is masked during the first clock of a read cycle when emerging from a deselected state.
\overline{ADV}	Input Synchronous	Advance input signal. Sampled on the rising edge of CLK. When asserted, it automatically increments the address in a burst cycle.
\overline{ADSP}	Input Synchronous	Address strobe from processor, sampled on the rising edge of CLK, active LOW. When asserted LOW, addresses presented to the device are captured in the address registers. $A_{[1:0]}$ are also loaded into the burst counter. When \overline{ADSP} and \overline{ADSC} are both asserted, only \overline{ADSP} is recognized. \overline{ADSP} is ignored when \overline{CE}_1 is deasserted HIGH.
\overline{ADSC}	Input Synchronous	Address strobe from controller, sampled on the rising edge of CLK, active LOW. When asserted LOW, addresses presented to the device are captured in the address registers. $A_{[1:0]}$ are also loaded into the burst counter. When \overline{ADSP} and \overline{ADSC} are both asserted, only \overline{ADSP} is recognized.
\overline{BWE}	Input Synchronous	Byte write enable input, active LOW. Sampled on the rising edge of CLK. This signal must be asserted LOW to conduct a byte write.
ZZ	Input Asynchronous	ZZ sleep input. This active HIGH input places the device in a non time critical sleep condition with data integrity preserved. For normal operation, this pin has to be LOW or left floating. ZZ pin has an internal pull down.
DQ_s	I/O Synchronous	Bidirectional data I/O lines. As inputs, they feed into an on-chip data register that is triggered by the rising edge of CLK. As outputs, they deliver the data contained in the memory location specified by the addresses presented during the previous clock rise of the read cycle. The direction of the pins is controlled by \overline{OE} . When \overline{OE} is asserted LOW, the pins behave as outputs. When HIGH, DQ_s and DQP_x are placed in a tristate condition. The outputs are automatically tristated during the data portion of a write sequence, during the first clock when emerging from a deselected state, and when the device is deselected, regardless of the state of \overline{OE} .
DQP_x	I/O Synchronous	Bidirectional data parity I/O lines. Functionally, these signals are identical to DQ_s . During write sequences, DQP_x is controlled by \overline{BW}_x correspondingly.
MODE	Input Static	Selects burst order. When tied to GND, selects linear burst sequence. When tied to V_{DD} or left floating, selects interleaved burst sequence. This is a strap pin and must remain static during device operation. Mode pin has an internal pull-up.

Pin Definitions (continued)

Name	I/O	Description
V _{DD}	Power Supply	Power supply inputs to the core of the device.
V _{DDQ}	I/O Power Supply	Power supply for the I/O circuitry.
V _{SS}	Ground	Ground for the core of the device.
V _{SSQ}	I/O Ground	Ground for the I/O circuitry.
NC	–	No connects. Not internally connected to the die. 36M, 72M, 144M, 288M, 576M, and 1G are address expansion pins and are not internally connected to the die.
V _{SS} /DNU	Ground/DNU	This pin can be connected to ground or can be left floating.

Functional Overview

All synchronous inputs pass through input registers controlled by the rising edge of the clock. Maximum access delay from the clock rise (t_{CDV}) is 6.5 ns (133 MHz device).

CY7C1381KVE33 supports secondary cache in systems using a linear or interleaved burst sequence. The burst order is user selectable, and is determined by sampling the MODE input. Accesses can be initiated with the processor address strobe (ADSP) or the controller address strobe (ADSC). Address advancement through the burst sequence is controlled by the ADV input. A two-bit on-chip wraparound burst counter captures the first address in a burst sequence and automatically increments the address for the rest of the burst access.

Byte write operations are qualified with the byte write enable (\overline{BWE}) and byte write select (BW_X) inputs. A global write enable (GW) overrides all byte write inputs and writes data to all four bytes. All writes are simplified with on-chip synchronous self-timed write circuitry.

Three synchronous chip selects (\overline{CE}_1 , CE_2 , \overline{CE}_3) and an asynchronous output enable (\overline{OE}) provide for easy bank selection and output tristate control. ADSP is ignored if \overline{CE}_1 is HIGH.

Single Read Accesses

A single read access is initiated when the following conditions are satisfied at clock rise: (1) \overline{CE}_1 , CE_2 , and \overline{CE}_3 are all asserted active, and (2) ADSP or ADSC is asserted LOW (if the access is initiated by ADSC, the write inputs must be deasserted during this first cycle). The address presented to the address inputs is latched into the address register and the burst counter and/or control logic, and later presented to the memory core. If the OE input is asserted LOW, the requested data is available at the data outputs with a maximum to t_{CDV} after clock rise. ADSP is ignored if \overline{CE}_1 is HIGH.

Single Write Accesses Initiated by ADSP

This access is initiated when the following conditions are satisfied at clock rise: (1) \overline{CE}_1 , CE_2 , and \overline{CE}_3 are all asserted active, and (2) ADSP is asserted LOW. The addresses presented are loaded into the address register and the burst inputs (GW, \overline{BWE} , and BW_X) are ignored during this first clock cycle. If the write inputs are asserted active (see [Truth Table for Read/Write on page 9](#) for appropriate states that indicate a write)

on the next clock rise, the appropriate data is latched and written into the device. Byte writes are allowed. All I/O are tristated during a byte write. Because this is a common I/O device, the asynchronous \overline{OE} input signal must be deasserted and the I/O must be tristated before the presentation of data to DQs. As a precaution, the data lines are tristated when a write cycle is detected, regardless of the state of \overline{OE} .

Single Write Accesses Initiated by \overline{ADSC}

This write access is initiated when the following conditions are satisfied at clock rise: (1) \overline{CE}_1 , CE_2 , and \overline{CE}_3 are all asserted active, (2) \overline{ADSC} is asserted LOW, (3) ADSP is deasserted HIGH, and (4) the write input signals (GW, \overline{BWE} , and BW_X) indicate a write access. \overline{ADSC} is ignored if ADSP is active LOW.

The addresses presented are loaded into the address register and the burst counter, the control logic, or both, and delivered to the memory core. The information presented to $DQ_{[A:D]}$ is written into the specified address location. Byte writes are allowed. All I/O are tristated when a write is detected, even a byte write. Because this is a common I/O device, the asynchronous \overline{OE} input signal must be deasserted and the I/O must be tristated prior to the presentation of data to DQs. As a precaution, the data lines are tristated when a write cycle is detected, regardless of the state of \overline{OE} .

Burst Sequences

CY7C1381KVE33 provides an on-chip two-bit wraparound burst counter inside the SRAM. The burst counter is fed by $A_{[1:0]}$ and can follow either a linear or interleaved burst order. The burst order is determined by the state of the MODE input. A LOW on MODE selects a linear burst sequence. A HIGH on MODE selects an interleaved burst order. Leaving MODE unconnected causes the device to default to a interleaved burst sequence.

Sleep Mode

The ZZ input pin is an asynchronous input. Asserting ZZ places the SRAM in a power conservation sleep mode. Two clock cycles are required to enter into or exit from this sleep mode. While in this mode, data integrity is guaranteed. Accesses pending when entering the sleep mode are not considered valid nor is the completion of the operation guaranteed. The device must be deselected before entering the sleep mode. \overline{CE}_1 , CE_2 , \overline{CE}_3 , ADSP, and \overline{ADSC} must remain inactive for the duration of t_{ZZREC} after the ZZ input returns LOW.

Interleaved Burst Address Table

 (MODE = Floating or V_{DD})

First Address A1:A0	Second Address A1:A0	Third Address A1:A0	Fourth Address A1:A0
00	01	10	11
01	00	11	10
10	11	00	01
11	10	01	00

Linear Burst Address Table

(MODE = GND)

First Address A1:A0	Second Address A1:A0	Third Address A1:A0	Fourth Address A1:A0
00	01	10	11
01	10	11	00
10	11	00	01
11	00	01	10

ZZ Mode Electrical Characteristics

Parameter	Description	Test Conditions	Min	Max	Unit
I_{DDZZ}	Sleep mode standby current	$ZZ \geq V_{DD} - 0.2 V$	–	90	mA
t_{ZZS}	Device operation to ZZ	$ZZ \geq V_{DD} - 0.2 V$	–	$2t_{CYC}$	ns
t_{ZZREC}	ZZ recovery time	$ZZ \leq 0.2 V$	$2t_{CYC}$	–	ns
t_{ZZI}	ZZ active to sleep current	This parameter is sampled	–	$2t_{CYC}$	ns
t_{RZZI}	ZZ inactive to exit sleep current	This parameter is sampled	0	–	ns

Truth Table

The truth table for CY7C1381KVE33 follows. [1, 2, 3, 4, 5]

Cycle Description	Address Used	\overline{CE}_1	CE_2	\overline{CE}_3	ZZ	\overline{ADSP}	\overline{ADSC}	\overline{ADV}	\overline{WRITE}	\overline{OE}	CLK	DQ
Deselected Cycle, Power Down	None	H	X	X	L	X	L	X	X	X	L-H	Tri-State
Deselected Cycle, Power Down	None	L	L	X	L	L	X	X	X	X	L-H	Tri-State
Deselected Cycle, Power Down	None	L	X	H	L	L	X	X	X	X	L-H	Tri-State
Deselected Cycle, Power Down	None	L	L	X	L	H	L	X	X	X	L-H	Tri-State
Deselected Cycle, Power Down	None	X	X	H	L	H	L	X	X	X	L-H	Tri-State
Sleep Mode, Power Down	None	X	X	X	H	X	X	X	X	X	X	Tri-State
Read Cycle, Begin Burst	External	L	H	L	L	L	X	X	X	L	L-H	Q
Read Cycle, Begin Burst	External	L	H	L	L	L	X	X	X	H	L-H	Tri-State
Write Cycle, Begin Burst	External	L	H	L	L	H	L	X	L	X	L-H	D
Read Cycle, Begin Burst	External	L	H	L	L	H	L	X	H	L	L-H	Q
Read Cycle, Begin Burst	External	L	H	L	L	H	L	X	H	H	L-H	Tri-State
Read Cycle, Continue Burst	Next	X	X	X	L	H	H	L	H	L	L-H	Q
Read Cycle, Continue Burst	Next	X	X	X	L	H	H	L	H	H	L-H	Tri-State
Read Cycle, Continue Burst	Next	H	X	X	L	X	H	L	H	L	L-H	Q
Read Cycle, Continue Burst	Next	H	X	X	L	X	H	L	H	H	L-H	Tri-State
Write Cycle, Continue Burst	Next	X	X	X	L	H	H	L	L	X	L-H	D
Write Cycle, Continue Burst	Next	H	X	X	L	X	H	L	L	X	L-H	D
Read Cycle, Suspend Burst	Current	X	X	X	L	H	H	H	H	L	L-H	Q
Read Cycle, Suspend Burst	Current	X	X	X	L	H	H	H	H	H	L-H	Tri-State
Read Cycle, Suspend Burst	Current	H	X	X	L	X	H	H	H	L	L-H	Q
Read Cycle, Suspend Burst	Current	H	X	X	L	X	H	H	H	H	L-H	Tri-State
Write Cycle, Suspend Burst	Current	X	X	X	L	H	H	H	L	X	L-H	D
Write Cycle, Suspend Burst	Current	H	X	X	L	X	H	H	L	X	L-H	D

Notes

1. X = Don't Care, H = Logic HIGH, L = Logic LOW.
2. \overline{WRITE} = L when any one or more byte write enable signals, and $\overline{BWE} = L$ or $\overline{GW} = L$. $\overline{WRITE} = H$ when all byte write enable signals, $\overline{BWE}, \overline{GW} = H$.
3. The DQ pins are controlled by the current cycle and the \overline{OE} signal. \overline{OE} is asynchronous and is not sampled with the clock.
4. The SRAM always initiates a read cycle when \overline{ADSP} is asserted, regardless of the state of $\overline{GW}, \overline{BWE},$ or \overline{BW}_x . Writes may occur only on subsequent clocks after the \overline{ADSP} or with the assertion of \overline{ADSC} . As a result, \overline{OE} must be driven HIGH prior to the start of the write cycle to allow the outputs to tristate. \overline{OE} is a don't care for the remainder of the write cycle.
5. \overline{OE} is asynchronous and is not sampled with the clock rise. It is masked internally during write cycles. During a read cycle all data bits are tristate when \overline{OE} is inactive or when the device is deselected, and all data bits behave as output when \overline{OE} is active (LOW).

Truth Table for Read/Write

The truth table for CY7C1381KVE33 read/write follows. [6, 7]

Function (CY7C1381KVE33)	\overline{GW}	\overline{BWE}	\overline{BW}_D	\overline{BW}_C	\overline{BW}_B	\overline{BW}_A
Read	H	H	X	X	X	X
Read	H	L	H	H	H	H
Write Byte A (DQ _A , DQP _A)	H	L	H	H	H	L
Write Byte B (DQ _B , DQP _B)	H	L	H	H	L	H
Write Bytes A, B (DQ _A , DQ _B , DQP _A , DQP _B)	H	L	H	H	L	L
Write Byte C (DQ _C , DQP _C)	H	L	H	L	H	H
Write Bytes C, A (DQ _C , DQ _A , DQP _C , DQP _A)	H	L	H	L	H	L
Write Bytes C, B (DQ _C , DQ _B , DQP _C , DQP _B)	H	L	H	L	L	H
Write Bytes C, B, A (DQ _C , DQ _B , DQ _A , DQP _C , DQP _B , DQP _A)	H	L	H	L	L	L
Write Byte D (DQ _D , DQP _D)	H	L	L	H	H	H
Write Bytes D, A (DQ _D , DQ _A , DQP _D , DQP _A)	H	L	L	H	H	L
Write Bytes D, B (DQ _D , DQ _B , DQP _D , DQP _B)	H	L	L	H	L	H
Write Bytes D, B, A (DQ _D , DQ _B , DQ _A , DQP _D , DQP _B , DQP _A)	H	L	L	H	L	L
Write Bytes D, B (DQ _D , DQ _B , DQP _D , DQP _B)	H	L	L	L	H	H
Write Bytes D, B, A (DQ _D , DQ _C , DQ _A , DQP _D , DQP _C , DQP _A)	H	L	L	L	H	L

Notes

6. X=Don't Care, H = Logic HIGH, L = Logic LOW.

7. The table only has a partial listing of the byte write combinations. Any combination of \overline{BW}_X is valid. Appropriate write is done based on which byte write is active.

Maximum Ratings

Exceeding the maximum ratings may impair the useful life of the device. For user guidelines, not tested.

- Storage Temperature -65 °C to +150 °C
- Case Temperature with Power Applied -55 °C to +125 °C
- Supply Voltage on V_{DD} Relative to GND -0.3 V to +4.6 V
- Supply Voltage on V_{DDQ} Relative to GND -0.3 V to +V_{DD}
- DC Voltage Applied to Outputs in Tristate -0.5 V to V_{DDQ} + 0.5 V
- DC Input Voltage -0.5 V to V_{DD} + 0.5 V
- Current into Outputs (LOW) 20 mA
- Static Discharge Voltage (per MIL-STD-883, Method 3015) > 2001 V
- Latch-up Current > 200 mA

Operating Range

Range	Case Temperature	V _{DD}	V _{DDQ}
Military	-55 °C to +125 °C	3.3 V - 5% / + 10%	2.5 V - 5% to V _{DD}

Neutron Soft Error Immunity

Parameter	Description	Test Conditions	Typ	Max*	Unit
LSBU	Logical Single-Bit Upsets	25 °C	0	0.01	FIT/Mb
LMBU	Logical Multi-Bit Upsets	25 °C	0	0.01	FIT/Mb
SEL	Single Event Latch up	85 °C	0	0.1	FIT/Dev

* No LMBU or SEL events occurred during testing; this column represents a statistical χ^2 , 95 percent confidence limit calculation. For more details refer to Application Note, AN54908 – Accelerated Neutron SER Testing and Calculation of Terrestrial Failure Rates.

Electrical Characteristics

Over the Operating Range

Parameter ^[8, 9]	Description	Test Conditions	Min	Max	Unit
V _{DD}	Power Supply Voltage		3.135	3.6	V
V _{DDQ}	I/O Supply Voltage	for 3.3 V I/O	3.135	V _{DD}	V
		for 2.5 V I/O	2.375	2.625	V
V _{OH}	Output HIGH Voltage	for 3.3 V I/O, I _{OH} = -4.0 mA	2.4	-	V
		for 2.5 V I/O, I _{OH} = -1.0 mA	2.0	-	V
V _{OL}	Output LOW Voltage	for 3.3 V I/O, I _{OL} = 8.0 mA	-	0.4	V
		for 2.5 V I/O, I _{OL} = 1.0 mA	-	0.4	V
V _{IH}	Input HIGH Voltage ^[8]	for 3.3 V I/O	2.0	V _{DD} + 0.3	V
		for 2.5 V I/O	1.7	V _{DD} + 0.3	V
V _{IL}	Input LOW Voltage ^[8]	for 3.3 V I/O	-0.3	0.8	V
		for 2.5 V I/O	-0.3	0.7	V

Notes

- 8. Overshoot: V_{IH(AC)} < V_{DD} + 1.5 V (pulse width less than t_{CYC}/2), undershoot: V_{IL(AC)} > -2 V (pulse width less than t_{CYC}/2).
- 9. T_{Power-up}: Assumes a linear ramp from 0 V to V_{DD(min.)} of at least 200 ms. During this time V_{IH} < V_{DD} and V_{DDQ} ≤ V_{DD}.

Electrical Characteristics *(continued)*

Over the Operating Range

Parameter ^[8, 9]	Description	Test Conditions		Min	Max	Unit
I _X	Input Leakage Current except ZZ and MODE	GND ≤ V _I ≤ V _{DDQ}		-5	5	μA
	Input Current of MODE	Input = V _{SS}		-30	-	
		Input = V _{DD}		-	5	
	Input Current of ZZ	Input = V _{SS}			-5	
Input = V _{DD}				-	30	
I _{OZ}	Output Leakage Current	GND ≤ V _I ≤ V _{DDQ} , Output Disabled		-5	5	μA
I _{DD}	V _{DD} Operating Supply	V _{DD} = Max., I _{OUT} = 0 mA, f = f _{MAX} = 1/t _{CYC}	133 MHz × 36	-	160	mA
I _{SB1}	Automatic CE Power-down Current – TTL Inputs	Max. V _{DD} , Device Deselected, V _{IN} ≥ V _{IH} or V _{IN} ≤ V _{IL} , f = f _{MAX} = 1/t _{CYC}	133 MHz × 36	-	100	mA
I _{SB2}	Automatic CE Power-down Current – CMOS Inputs	Max. V _{DD} , Device Deselected, V _{IN} ≤ 0.3 V or V _{IN} ≥ V _{DDQ} - 0.3 V, f = 0	133 MHz × 36	-	90	mA
I _{SB3}	Automatic CE Power-down Current – CMOS Inputs	Max. V _{DD} , Device Deselected, V _{IN} ≤ 0.3 V or V _{IN} ≥ V _{DDQ} - 0.3 V, f = f _{MAX} = 1/t _{CYC}	133 MHz × 36	-	100	mA
I _{SB4}	Automatic CE Power-down Current – TTL Inputs	Max. V _{DD} , Device Deselected, V _{IN} ≥ V _{IH} or V _{IN} ≤ V _{IL} , f = 0	133 MHz × 36	-	90	mA

Capacitance

Parameter	Description	Test Conditions	100-pin TQFP Package	Unit
C_{IN}	Input capacitance	$T_A = 25\text{ }^\circ\text{C}$, $f = 1\text{ MHz}$, $V_{DD} = 3.3\text{ V}$, $V_{DDQ} = 2.5\text{ V}$	5	pF
C_{CLK}	Clock input capacitance		5	pF
C_{IO}	Input/output capacitance		5	pF

Thermal Resistance

Parameter	Description	Test Conditions	100-pin TQFP Package	Unit
Θ_{JC}	Thermal resistance (junction to case)	Test conditions follow standard test methods and procedures for measuring thermal impedance, according to EIA/JESD51.	8.36	$^\circ\text{C/W}$

AC Test Loads and Waveforms

Figure 2. AC Test Loads and Waveforms

3.3 V I/O Test Load

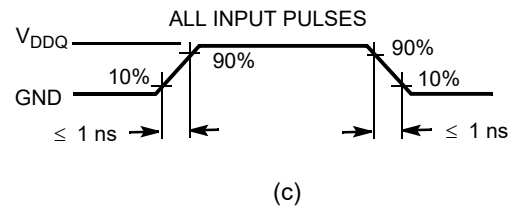
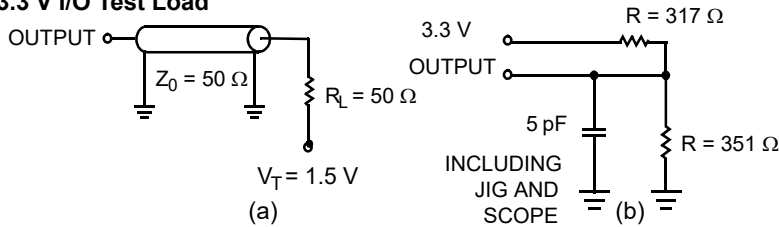

2.5 V I/O Test Load

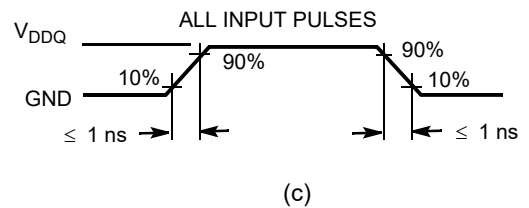
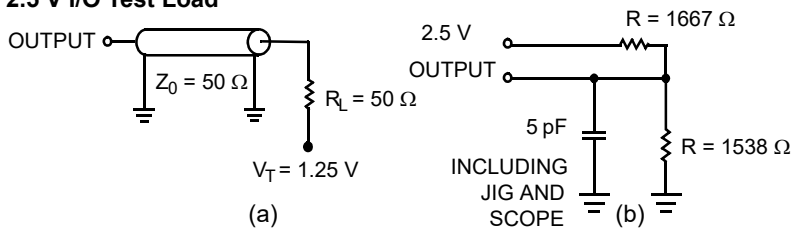

Switching Characteristics

Over the Operating Range

Parameter ^[10, 11]	Description	133 MHz		Unit
		Min	Max	
t _{POWER}	V _{DD} (typical) to the first access ^[12]	1	–	ms
Clock				
t _{CYC}	Clock cycle time	7.5	–	ns
t _{CH}	Clock HIGH	2.1	–	ns
t _{CL}	Clock LOW	2.1	–	ns
Output Times				
t _{CDV}	Data output valid after CLK rise	–	6.5	ns
t _{DOH}	Data output hold after CLK rise	2.0	–	ns
t _{CLZ}	Clock to low Z ^[13, 14, 15]	2.0	–	ns
t _{CHZ}	Clock to high Z ^[13, 14, 15]	0	4.0	ns
t _{OEV}	$\overline{\text{OE}}$ LOW to output valid	–	3.2	ns
t _{OELZ}	$\overline{\text{OE}}$ LOW to output low Z ^[13, 14, 15]	0	–	ns
t _{OEHZ}	$\overline{\text{OE}}$ HIGH to output high Z ^[13, 14, 15]	–	4.0	ns
Setup Times				
t _{AS}	Address setup before CLK rise	1.5	–	ns
t _{ADS}	ADSP, ADSC setup before CLK rise	1.5	–	ns
t _{ADVS}	$\overline{\text{ADV}}$ setup before CLK rise	1.5	–	ns
t _{WES}	$\overline{\text{GW}}$, $\overline{\text{BWE}}$, $\overline{\text{BW}}_{[\text{A:D}]}$ setup before CLK rise	1.5	–	ns
t _{DS}	Data input setup before CLK rise	1.5	–	ns
t _{CES}	Chip enable setup	1.5	–	ns
Hold Times				
t _{AH}	Address hold after CLK rise	0.5	–	ns
t _{ADH}	ADSP, ADSC hold after CLK rise	0.5	–	ns
t _{WEH}	$\overline{\text{GW}}$, $\overline{\text{BWE}}$, $\overline{\text{BW}}_{[\text{A:D}]}$ hold after CLK rise	0.5	–	ns
t _{ADVH}	$\overline{\text{ADV}}$ hold after CLK rise	0.5	–	ns
t _{DH}	Data input hold after CLK rise	0.5	–	ns
t _{CEH}	Chip enable hold after CLK rise	0.5	–	ns

Notes

10. Timing reference level is 1.5 V when V_{DDQ} = 3.3 V and is 1.25 V when V_{DDQ} = 2.5 V.

11. Test conditions shown in (a) of [Figure 2 on page 12](#) unless otherwise noted.

12. This part has a voltage regulator internally; t_{POWER} is the time that the power needs to be supplied above V_{DD(minimum)} initially, before a read or write operation can be initiated.

13. t_{CHZ}, t_{CLZ}, t_{OELZ}, and t_{OEHZ} are specified with AC test conditions shown in part (b) of [Figure 2 on page 12](#). Transition is measured ±200 mV from steady-state voltage

14. At any given voltage and temperature, t_{OEHZ} is less than t_{OELZ} and t_{CHZ} is less than t_{CLZ} to eliminate bus contention between SRAMs when sharing the same data bus. These specifications do not imply a bus contention condition, but reflect parameters guaranteed over worst-case user conditions. The device is designed to achieve high-Z before low-Z under the same system condition.

15. This parameter is sampled and not 100 percent tested.

Timing Diagrams

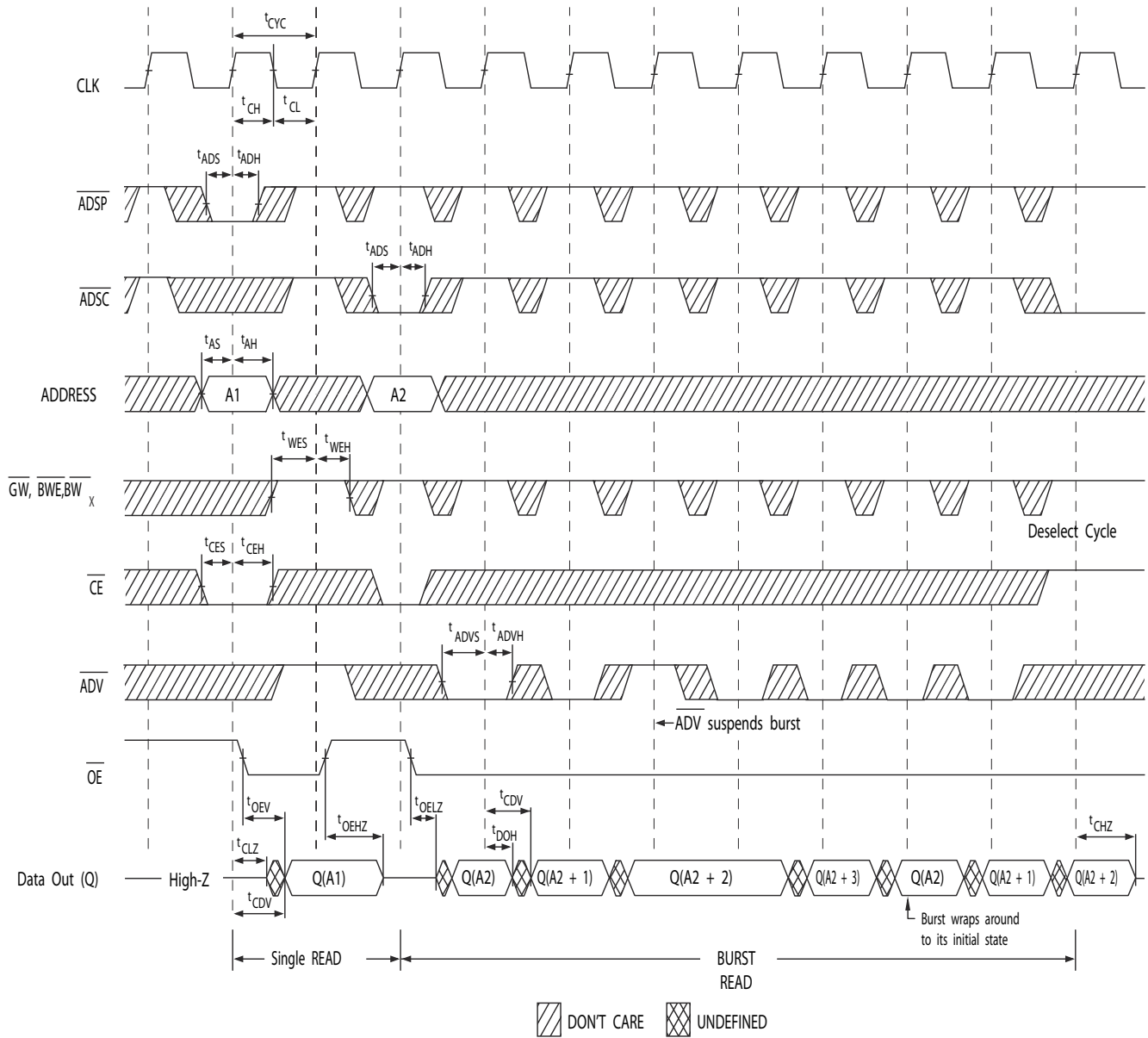
Figure 3. Read Cycle Timing [16]

Note

16. In this diagram, when \overline{CE} is LOW: \overline{CE}_1 is LOW, CE_2 is HIGH, and \overline{CE}_3 is LOW. When \overline{CE} is HIGH: \overline{CE}_1 is HIGH, CE_2 is LOW, or \overline{CE}_3 is HIGH.

Timing Diagrams (continued)

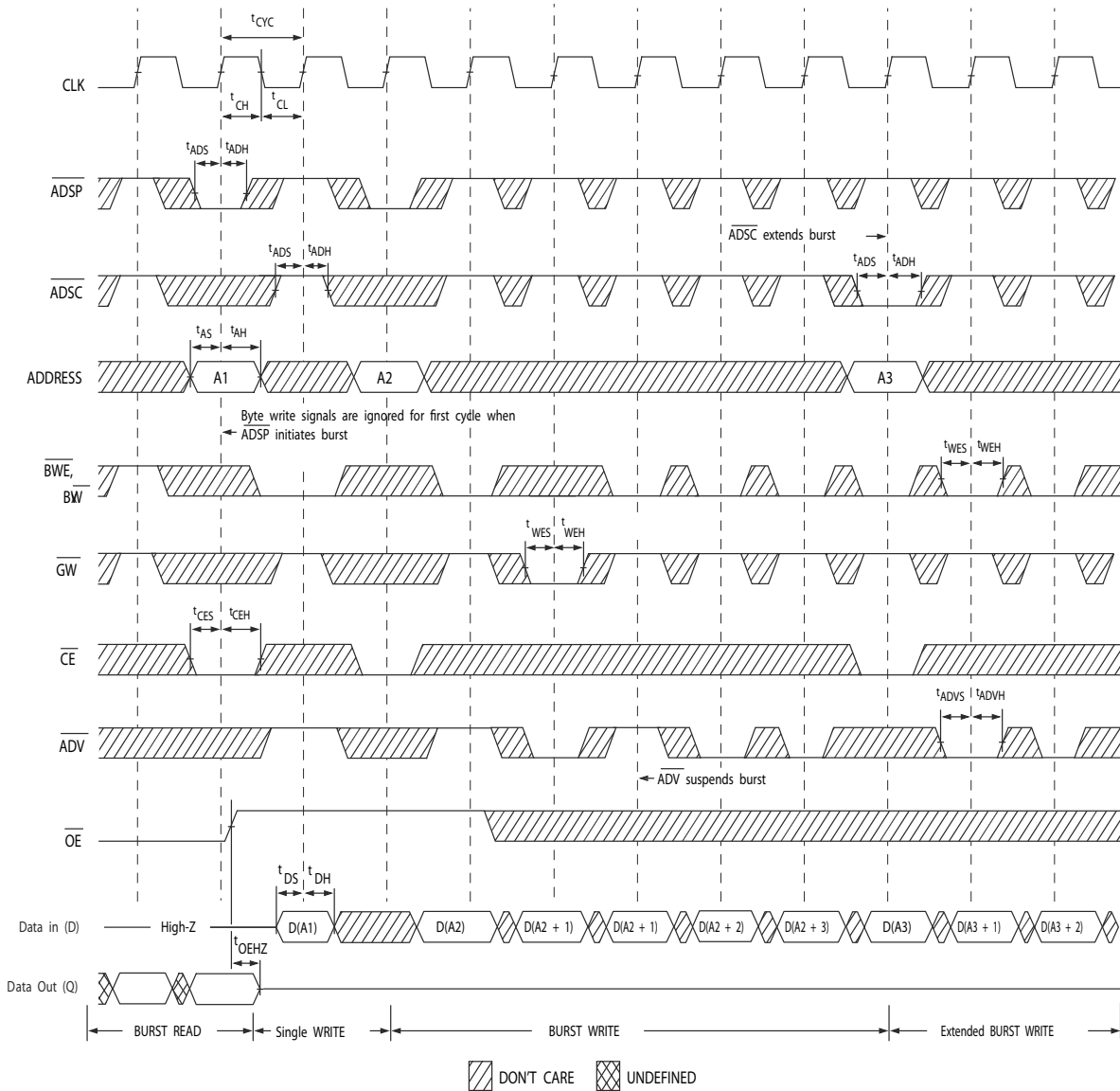
Figure 4. Write Cycle Timing [17, 18]



Notes

- 17. In this diagram, when \overline{CE} is LOW: \overline{CE}_1 is LOW, \overline{CE}_2 is HIGH, and \overline{CE}_3 is LOW. When \overline{CE} is HIGH: \overline{CE}_1 is HIGH, \overline{CE}_2 is LOW, or \overline{CE}_3 is HIGH.
- 18. Full-width write can be initiated by either \overline{GW} LOW; or by \overline{GW} HIGH, \overline{BWE} LOW, and \overline{BW}_X LOW.

Timing Diagrams (continued)

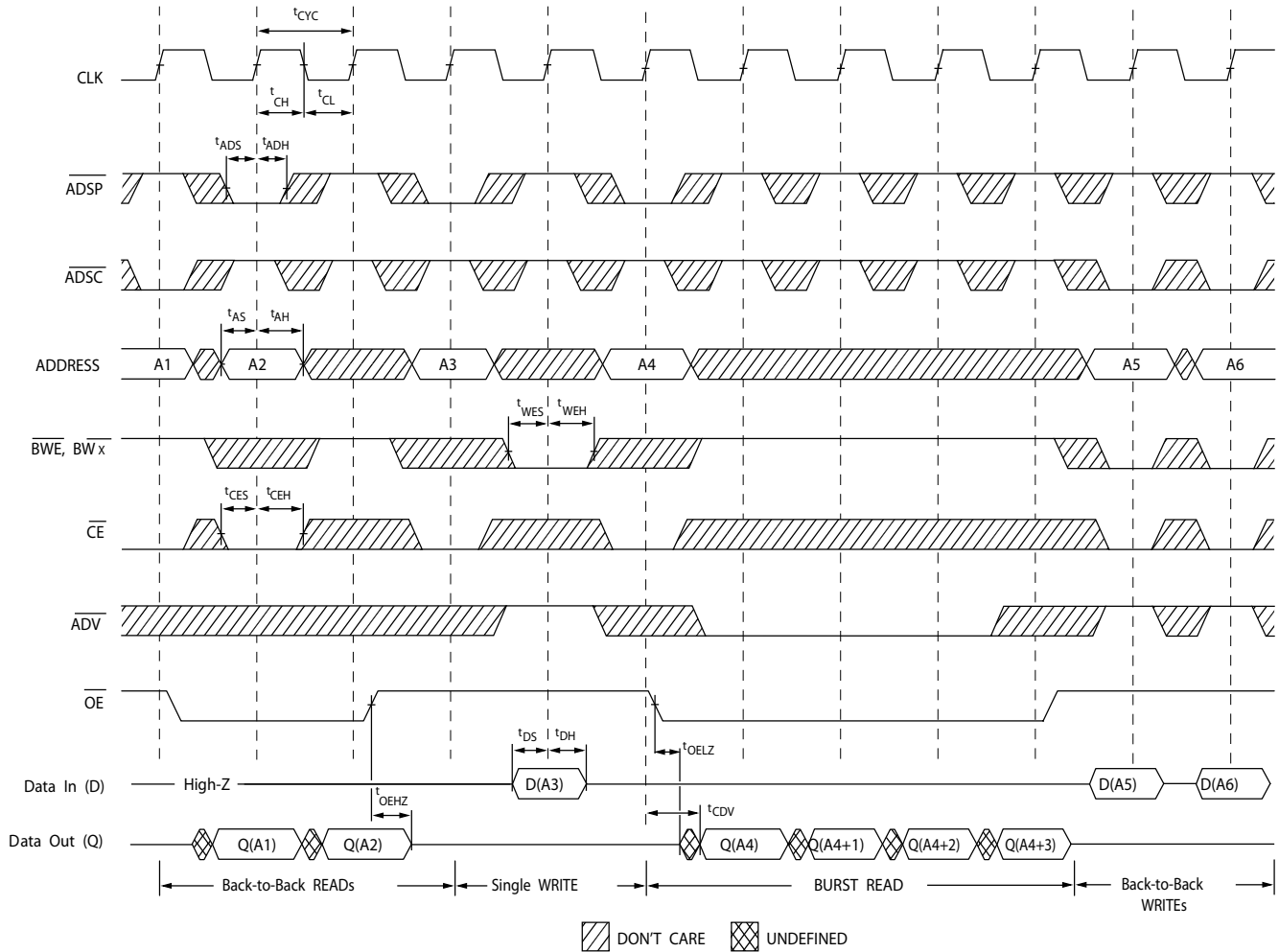
Figure 5. Read/Write Cycle Timing [19, 20, 21]

Notes

19. In this diagram, when \overline{CE} is LOW: \overline{CE}_1 is LOW, CE_2 is HIGH, and \overline{CE}_3 is LOW. When \overline{CE} is HIGH: \overline{CE}_1 is HIGH, CE_2 is LOW, or \overline{CE}_3 is HIGH.
 20. The data bus (Q) remains in high-Z following a Write cycle, unless a new read access is initiated by ADSP or ADSC.
 21. \overline{GW} is HIGH.

Timing Diagrams (continued)

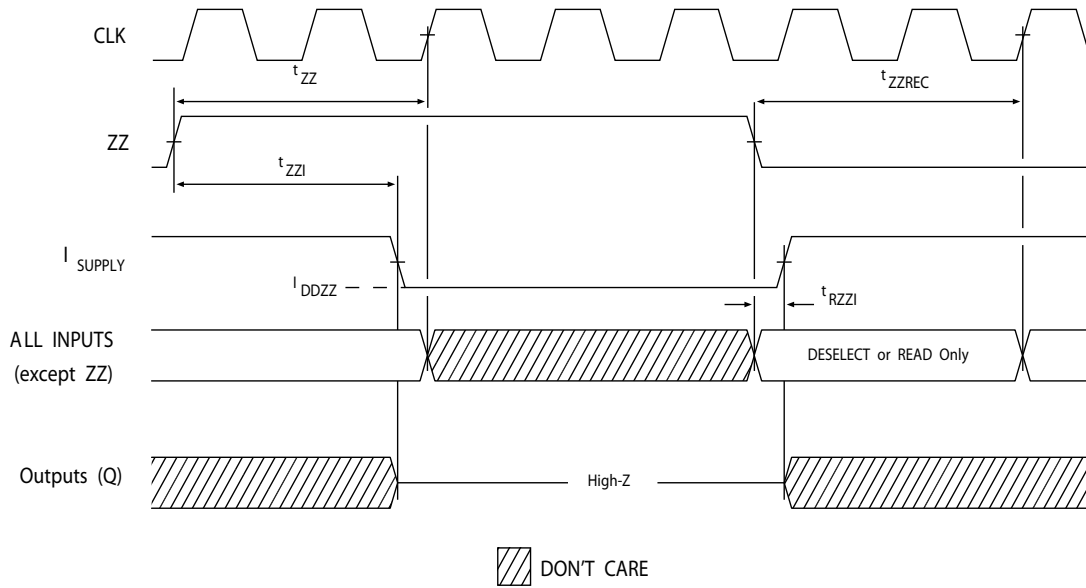
Figure 6. ZZ Mode Timing [22, 23]



Notes

- 22. Device must be deselected when entering ZZ mode. See Truth Table on page 8 for all possible signal conditions to deselect the device.
- 23. DQs are in high Z when exiting ZZ sleep mode.

Ordering Information

Cypress offers other versions of this product type in many different configurations and features. The following table contains only the list of parts that are currently available. For a complete listing of all options, visit the Cypress website at www.cypress.com and refer to the product summary page at www.cypress.com/products or contact your local sales representative. Cypress maintains a worldwide network of offices, solution centers, manufacturers' representatives and distributors. To find the office closest to you, visit www.cypress.com/go/datasheet/offices.

Speed (MHz)	Ordering Code	Package Diagram	Part and Package Type	Operating Range
133	CY7C1381KVE33-133AXM	51-85050	100-pin TQFP (14 × 20 × 1.4 mm) Lead-free	Military

Ordering Code Definitions

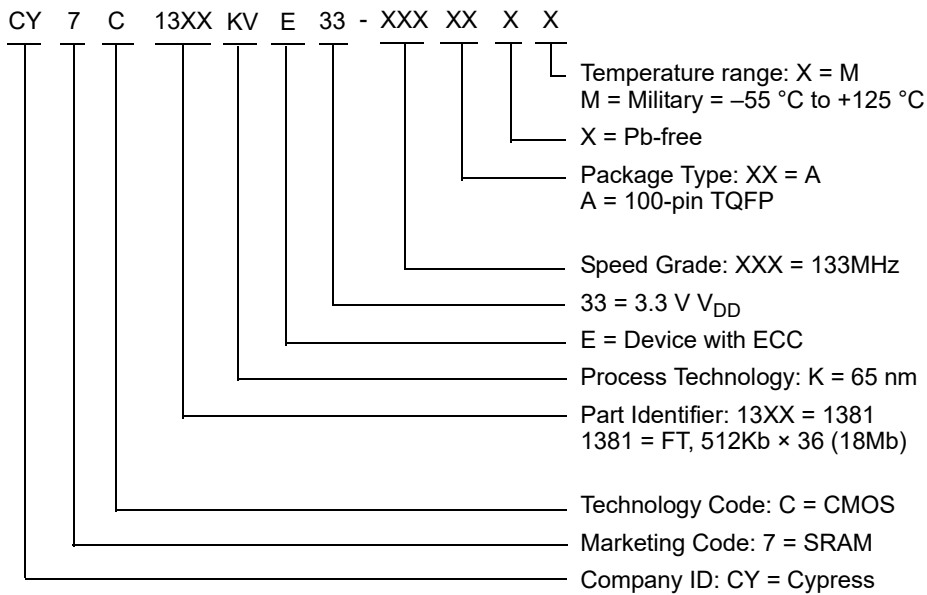

Acronyms

Acronym	Description
\overline{CE}	Chip Enable
CMOS	Complementary Metal Oxide Semiconductor
EIA	Electronic Industries Alliance
I/O	Input/Output
JEDEC	Joint Electron Devices Engineering Council
LMBU	Logical Multi-Bit Upsets
LSB	Least Significant Bit
LSBU	Logical Single-Bit Upsets
MSB	Most Significant Bit
\overline{OE}	Output Enable
SEL	Single Event Latch Up
SRAM	Static Random Access Memory
TQFP	Thin Quad Flat Pack
TTL	Transistor-Transistor Logic

Document Conventions

Units of Measure

Symbol	Unit of Measure
°C	degree Celsius
MHz	megahertz
μA	microampere
mA	milliampere
mm	millimeter
ms	millisecond
mV	millivolt
ns	nanosecond
Ω	ohm
%	percent
pF	picofarad
V	volt
W	watt

Document History Page

Document Title: CY7C1381KVE33, Military Temp, 18-Mbit (512K × 36) Flow-Through SRAM (With ECC) Document Number: 002-12853				
Rev.	ECN No.	Orig. of Change	Submission Date	Description of Change
**	5414121	PRIT	08/26/2016	New data sheet.
*A	6065307	CNX	02/09/2018	Updated Package Diagrams : spec 51-85050 – Changed revision from *E to *G. Updated to new template.

Sales, Solutions, and Legal Information

Worldwide Sales and Design Support

Cypress maintains a worldwide network of offices, solution centers, manufacturer's representatives, and distributors. To find the office closest to you, visit us at [Cypress Locations](#).

Products

Arm® Cortex® Microcontrollers	cypress.com/arm
Automotive	cypress.com/automotive
Clocks & Buffers	cypress.com/clocks
Interface	cypress.com/interface
Internet of Things	cypress.com/iot
Memory	cypress.com/memory
Microcontrollers	cypress.com/mcu
PSoC	cypress.com/psoc
Power Management ICs	cypress.com/pmic
Touch Sensing	cypress.com/touch
USB Controllers	cypress.com/usb
Wireless Connectivity	cypress.com/wireless

PSoC® Solutions

[PSoC 1](#) | [PSoC 3](#) | [PSoC 4](#) | [PSoC 5LP](#) | [PSoC 6 MCU](#)

Cypress Developer Community

[Community](#) | [Projects](#) | [Video](#) | [Blogs](#) | [Training](#) | [Components](#)

Technical Support

cypress.com/support

© Cypress Semiconductor Corporation, 2016-2018. This document is the property of Cypress Semiconductor Corporation and its subsidiaries, including Spansion LLC ("Cypress"). This document, including any software or firmware included or referenced in this document ("Software"), is owned by Cypress under the intellectual property laws and treaties of the United States and other countries worldwide. Cypress reserves all rights under such laws and treaties and does not, except as specifically stated in this paragraph, grant any license under its patents, copyrights, trademarks, or other intellectual property rights. If the Software is not accompanied by a license agreement and you do not otherwise have a written agreement with Cypress governing the use of the Software, then Cypress hereby grants you a personal, non-exclusive, nontransferable license (without the right to sublicense) (1) under its copyright rights in the Software (a) for Software provided in source code form, to modify and reproduce the Software solely for use with Cypress hardware products, only internally within your organization, and (b) to distribute the Software in binary code form externally to end users (either directly or indirectly through resellers and distributors), solely for use on Cypress hardware product units, and (2) under those claims of Cypress's patents that are infringed by the Software (as provided by Cypress, unmodified) to make, use, distribute, and import the Software solely for use with Cypress hardware products. Any other use, reproduction, modification, translation, or compilation of the Software is prohibited.

TO THE EXTENT PERMITTED BY APPLICABLE LAW, CYPRESS MAKES NO WARRANTY OF ANY KIND, EXPRESS OR IMPLIED, WITH REGARD TO THIS DOCUMENT OR ANY SOFTWARE OR ACCOMPANYING HARDWARE, INCLUDING, BUT NOT LIMITED TO, THE IMPLIED WARRANTIES OF MERCHANTABILITY AND FITNESS FOR A PARTICULAR PURPOSE. To the extent permitted by applicable law, Cypress reserves the right to make changes to this document without further notice. Cypress does not assume any liability arising out of the application or use of any product or circuit described in this document. Any information provided in this document, including any sample design information or programming code, is provided only for reference purposes. It is the responsibility of the user of this document to properly design, program, and test the functionality and safety of any application made of this information and any resulting product. Cypress products are not designed, intended, or authorized for use as critical components in systems designed or intended for the operation of weapons, weapons systems, nuclear installations, life-support devices or systems, other medical devices or systems (including resuscitation equipment and surgical implants), pollution control or hazardous substances management, or other uses where the failure of the device or system could cause personal injury, death, or property damage ("Unintended Uses"). A critical component is any component of a device or system whose failure to perform can be reasonably expected to cause the failure of the device or system, or to affect its safety or effectiveness. Cypress is not liable, in whole or in part, and you shall and hereby do release Cypress from any claim, damage, or other liability arising from or related to all Unintended Uses of Cypress products. You shall indemnify and hold Cypress harmless from and against all claims, costs, damages, and other liabilities, including claims for personal injury or death, arising from or related to any Unintended Uses of Cypress products.

Cypress, the Cypress logo, Spansion, the Spansion logo, and combinations thereof, WICED, PSoC, CapSense, EZ-USB, F-RAM, and Traveo are trademarks or registered trademarks of Cypress in the United States and other countries. For a more complete list of Cypress trademarks, visit cypress.com. Other names and brands may be claimed as property of their respective owners.