

NUMBER C-178691

3rd ANGLE PROJECTION

METRIC

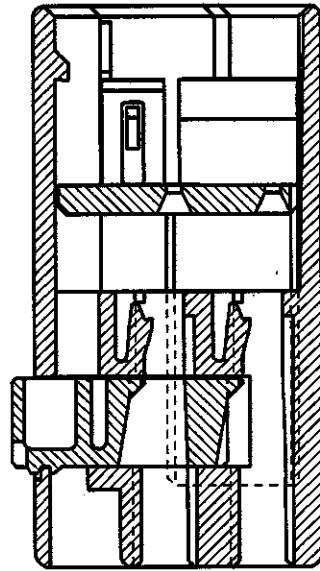
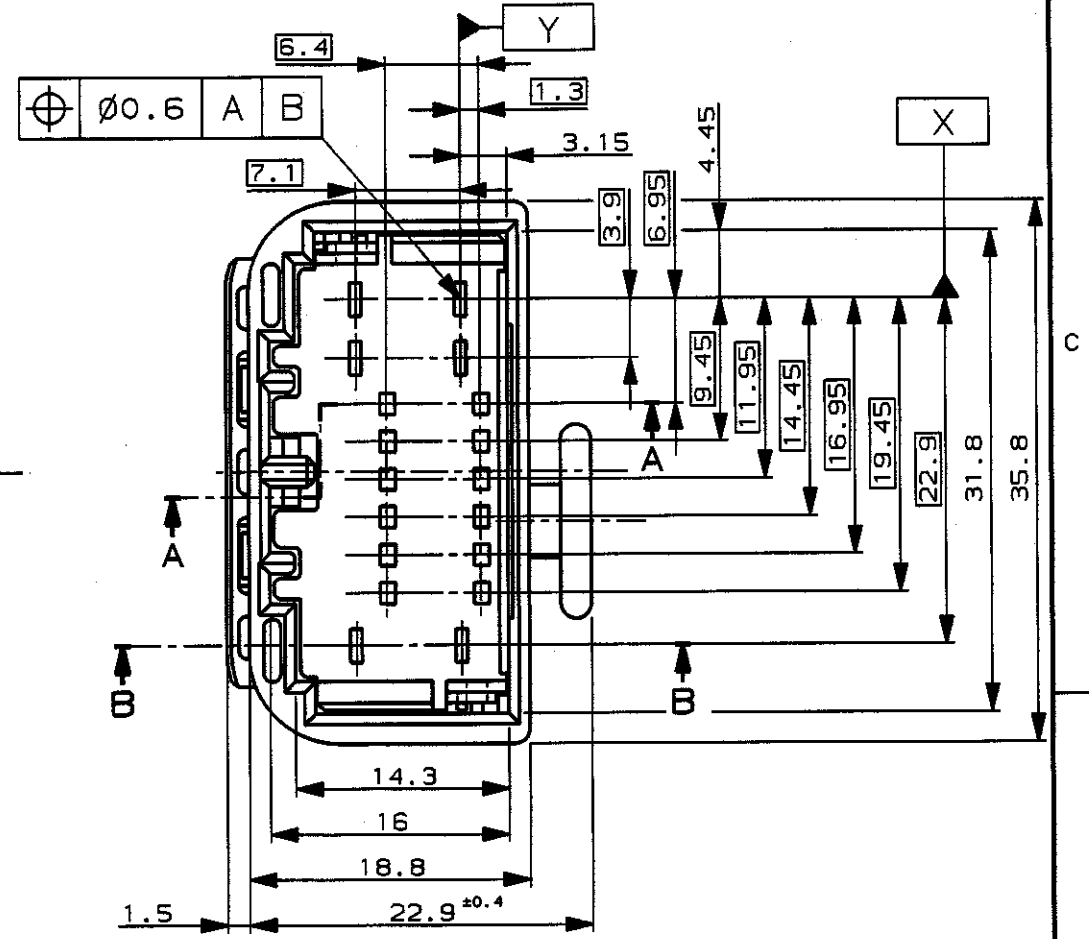
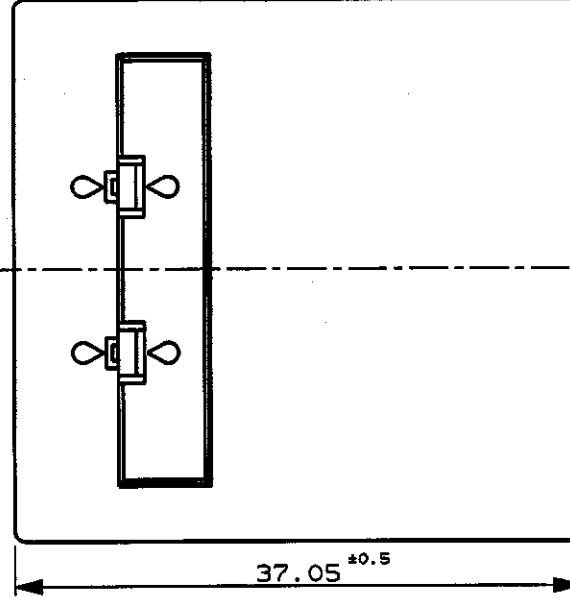
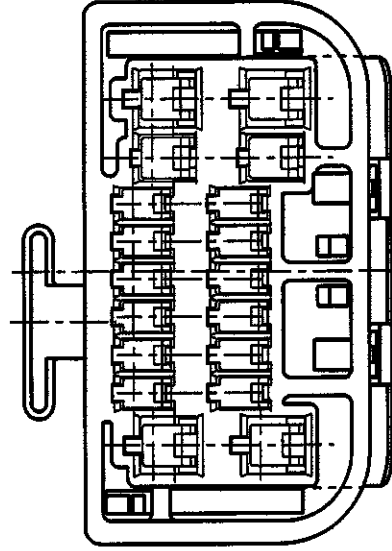
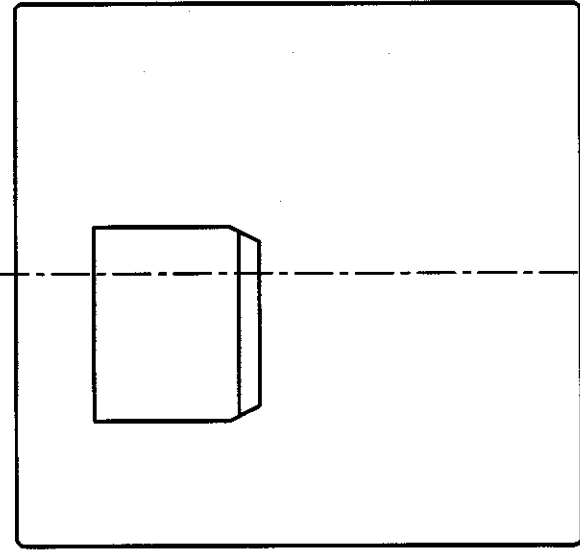

SECT. 断面 A-A

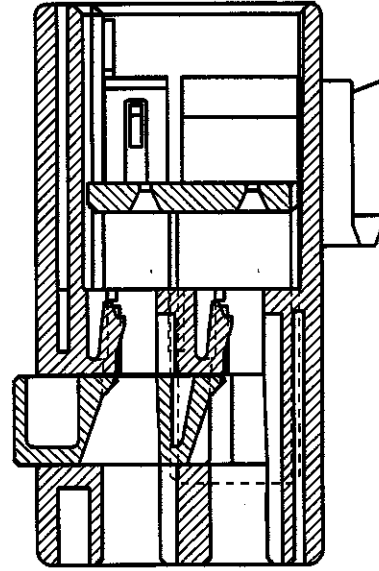

SECT. 断面 B-B

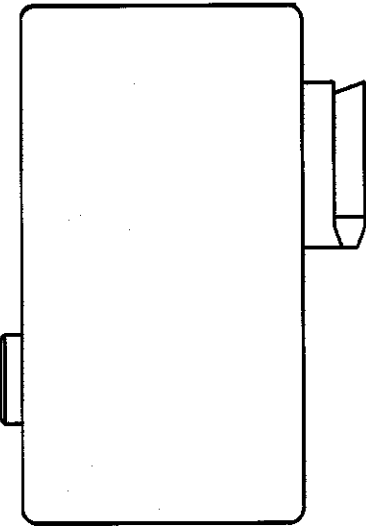

6- -6; AS SHOWN  
6- -6; 本図

注記

- 1 嵌合相手ハウジング型番 : 6-178692-6
- 2 適用製品規格番号 108-5374

NOTE,

- 1 MATING HOUSING P/N ; 6-178692-6
- 2 APPLICABLE PRODUCT SPEC NO.108-5374

Copyright ©1990年 AMP (Japan), LTD. ALL RIGHTS RESERVED.				Copyright ©1990 AMP (Japan), LTD. ALL RIGHTS RESERVED.				<b>AMP</b> 日本エー・エム・ピー株式会社 Tokyo, Japan	
名称 (NAME) 040II/070II STEERING COLUMN CONNECTOR 18POSITION CAP HOUSING 040II/070II ステアリング コラム コネクタ 18極 キャップハウジング				一般公差 (GENERAL TOLERANCE) 10以下: ±0.2 10を超え30以下: ±0.25 30を超え100以下: ±0.3 角 度: ±3°		SIZE LOC 番号 (No.) A3 J C-178691		尺 度 (SCALE) REV. SHEET 2-1 B2 1 OF 1	
B2 REVISED FJ00-0995-99 TS KB 09JUN 99		B1 ADD NOTE 2 FJ00-0937-99 TS KB 28MAY 99		B (REVISED) 変更 J-12551 KO SI 6/27 '91		A (REDRAWN) 再作成 KO SI 4/25 '91		LTR 変更 (REVISION RECORD) DR CHK DATE	
DR. Y. Fujimori 4/19 '91		DE. K. Oda 4/19 '91		CHK. S. Sato 6/27 '91		APP. S. Sato 4/25 '91			

PRINT DIST