

STELLA-HB

~75° high bay beam for warehouse and outdoor lighting. Compatible with up to 23 mm LES size COBs.

TECHNICAL SPECIFICATIONS:

Dimensions	Ø 90 mm
Height	19.5 mm
Fastening	screw
Colour	black
Box size	480 x 280 x 300 mm
Box weight	7.9 kg
Quantity in Box	135 pcs
ROHS compliant	yes ⓘ



MATERIAL SPECIFICATIONS:

Component	Type	Material	Colour
STELLA-HB	Lens	Silicone	clear
STELLA-FRAME	Holder	PA66	black

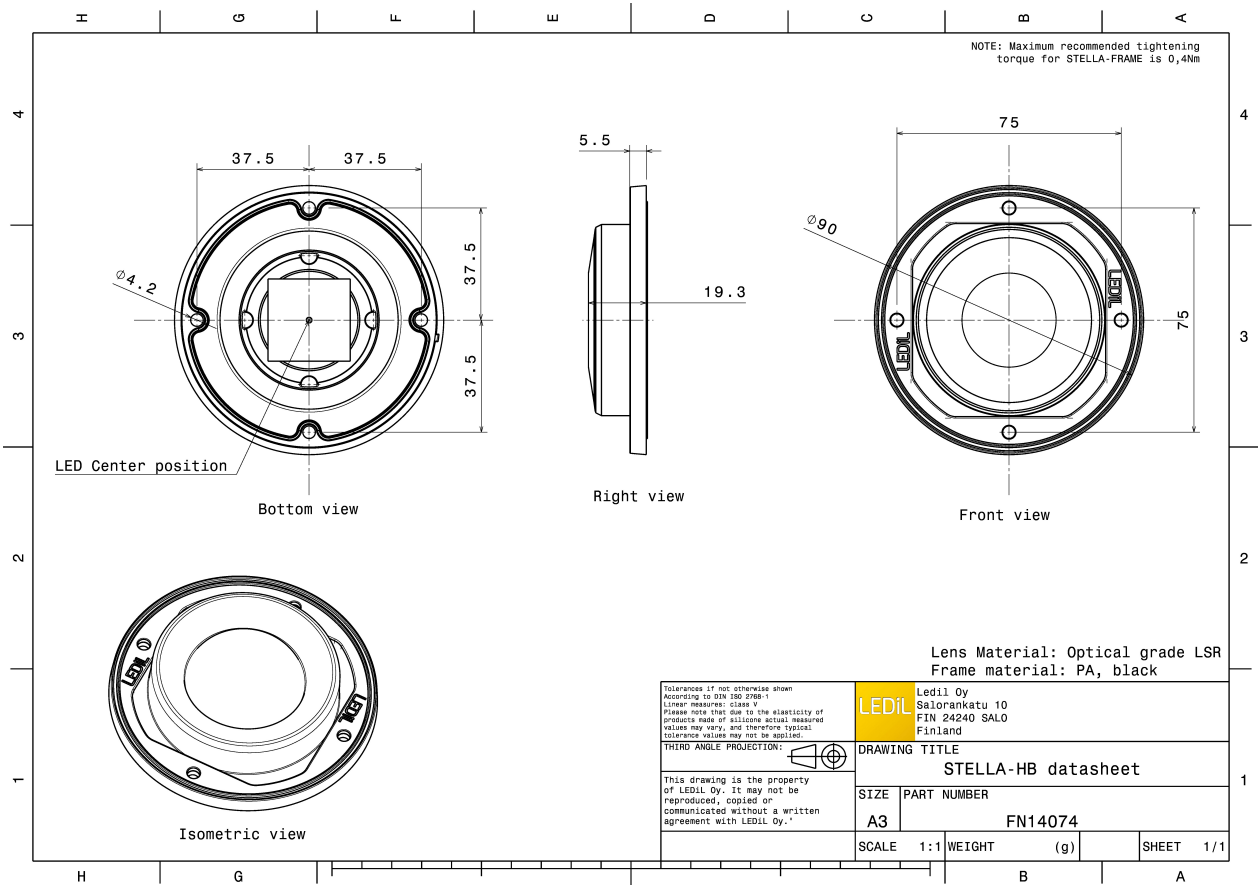

PHOTOMETRIC DATA (MEASURED):

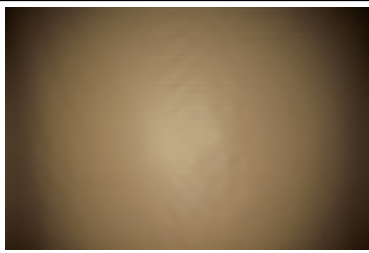
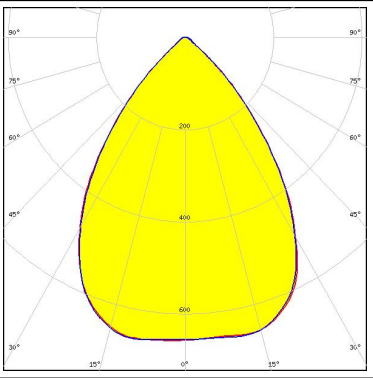
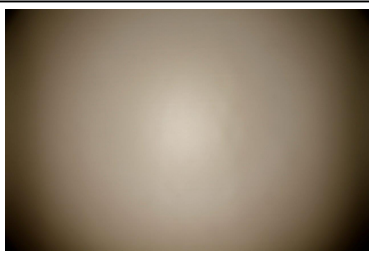
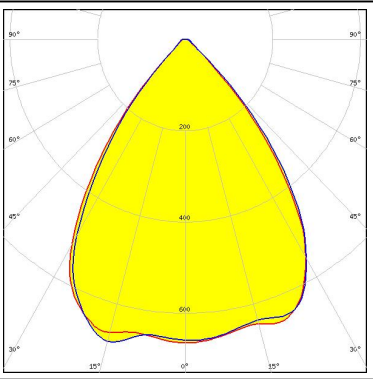
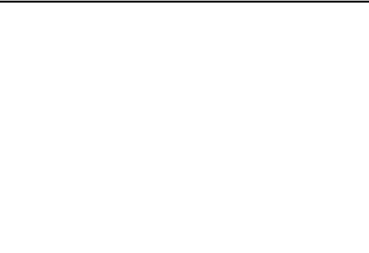
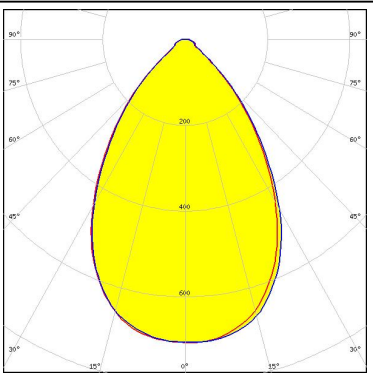
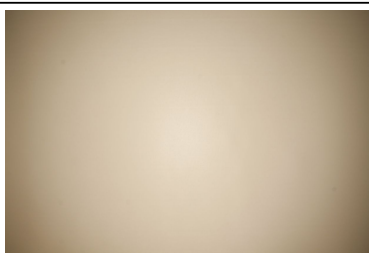
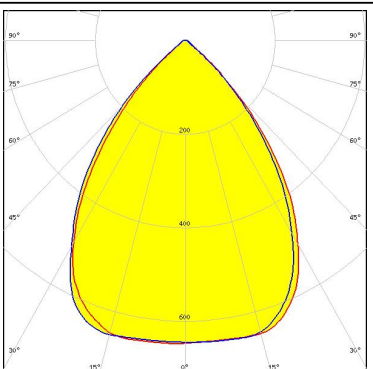
<p>bridgelux.</p> <p>LED V22 Gen7</p> <p>FWHM 75.0°</p> <p>Efficiency 93 %</p> <p>Peak intensity 0.660 cd/lm</p> <p>Required components:</p>		
<p>bridgelux.</p> <p>LED VERO18</p> <p>FWHM 75.0°</p> <p>Efficiency 93 %</p> <p>Peak intensity 0.700 cd/lm</p> <p>Required components:</p>		
<p>bridgelux.</p> <p>LED VERO29</p> <p>FWHM 69.0°</p> <p>Efficiency 94 %</p> <p>Peak intensity 0.708 cd/lm</p> <p>Required components:</p>		
<p>CITIZEN</p> <p>LED CLL04x/CLU04x</p> <p>FWHM 77.0°</p> <p>Efficiency 94 %</p> <p>Peak intensity 0.650 cd/lm</p> <p>Required components:</p>		

PHOTOMETRIC DATA (MEASURED):

CITIZEN

LED CLL04x/CLU04x
 FWHM 68.0°
 Efficiency 93 %
 Peak intensity 0.770 cd/lm
 Required components:
 Bender Wirth: 431 Typ L4

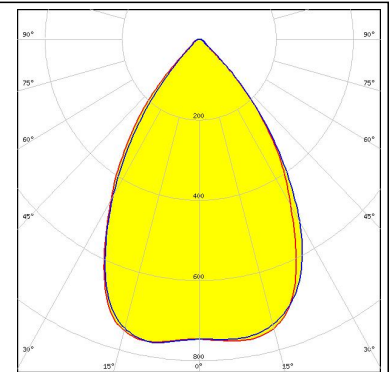
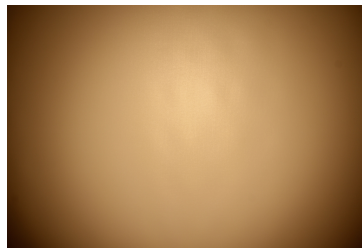

CITIZEN

LED CLL05x/CLU05x
 FWHM 73.0°
 Efficiency 93 %
 Peak intensity 0.630 cd/lm
 Required components:

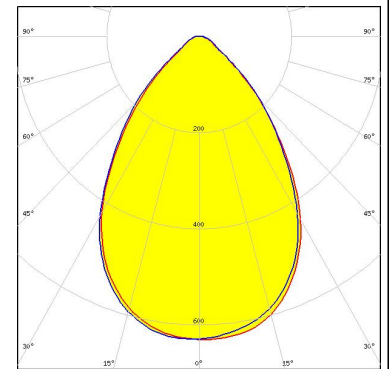
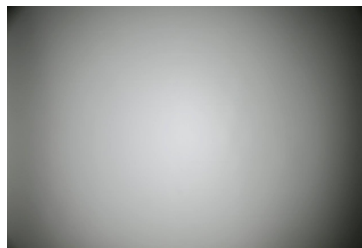

CITIZEN

LED CLL05x/CLU05x
 FWHM 65.0°
 Efficiency 94 %
 Peak intensity 0.740 cd/lm
 Required components:
 Bender Wirth: 458 Typ L4

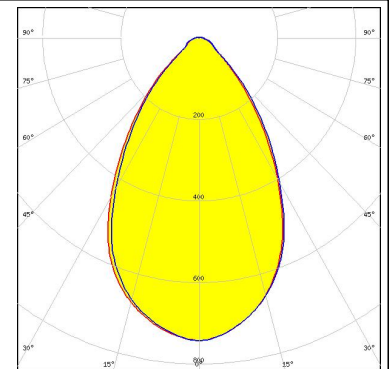
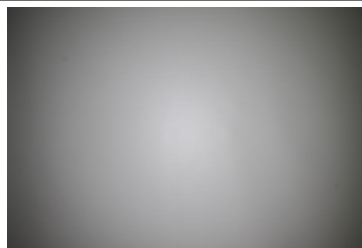

CREE

LED CMA2550
 FWHM 74.0°
 Efficiency 94 %
 Peak intensity 0.700 cd/lm
 Required components:

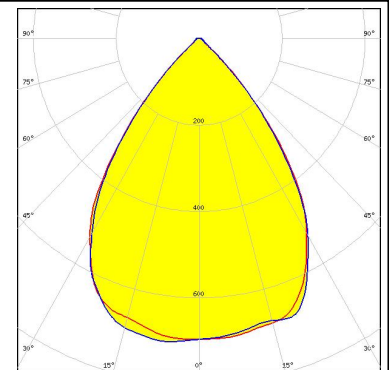
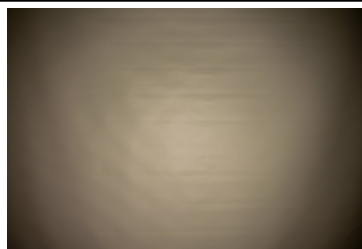

PHOTOMETRIC DATA (MEASURED):



LED CMA3090
 FWHM 67.0°
 Efficiency 96 %
 Peak intensity 0.800 cd/lm
 Required components:

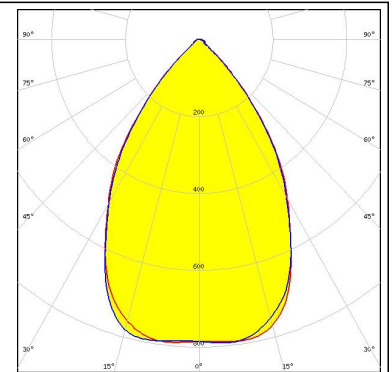

LED CXA/B 1816 & CXA/B 1820 & CXA 1850
 FWHM 87.0°
 Efficiency 93 %
 Peak intensity 0.600 cd/lm
 Required components:

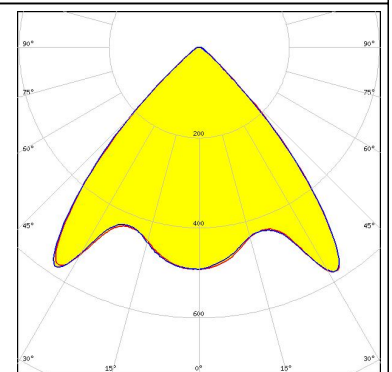
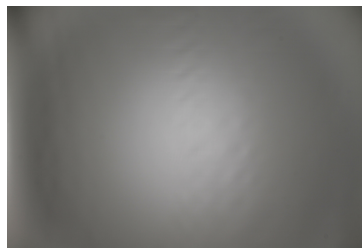

LED CXA/B 25xx
 FWHM 83.0°
 Efficiency 93 %
 Peak intensity 0.566 cd/lm
 Required components:

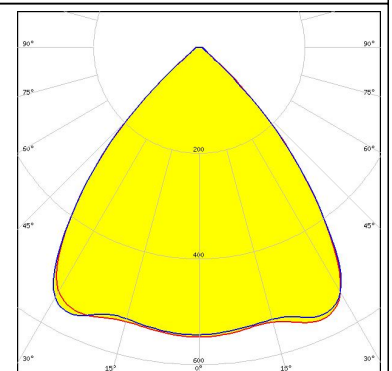

LED CXA/B 30xx
 FWHM 78.0°
 Efficiency 93 %
 Peak intensity 0.630 cd/lm
 Required components:

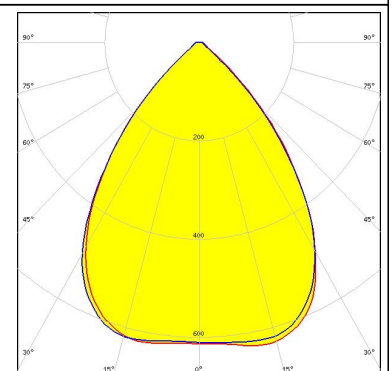

PHOTOMETRIC DATA (MEASURED):



LED CXA/B 3590
FWHM 72.0°
Efficiency 93 %
Peak intensity 0.682 cd/lm
Required components:

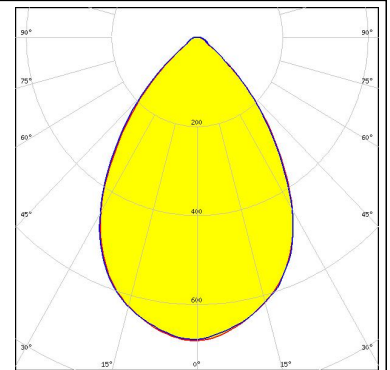

LED LUXEON CoB 1211
FWHM 71.0°
Efficiency 93 %
Peak intensity 0.730 cd/lm
Required components:

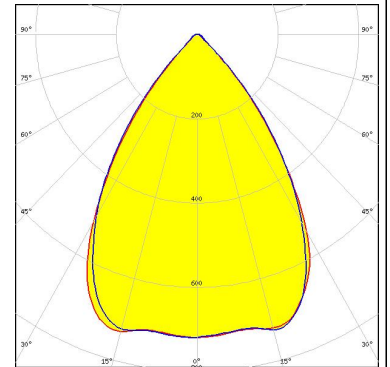
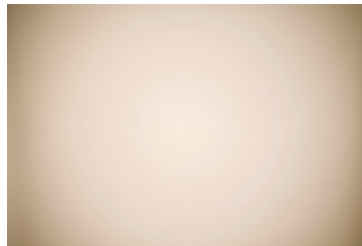

LED LUXEON CoB 1216/1812
FWHM 72.0°
Efficiency 94 %
Peak intensity 0.720 cd/lm
Required components:

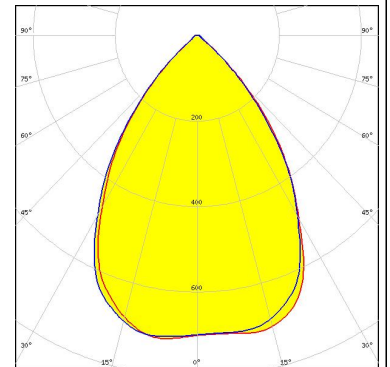

LED LUXEON CoB 1321
FWHM 71.0°
Efficiency 94 %
Peak intensity 0.700 cd/lm
Required components:

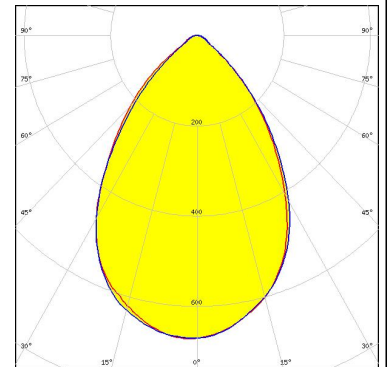
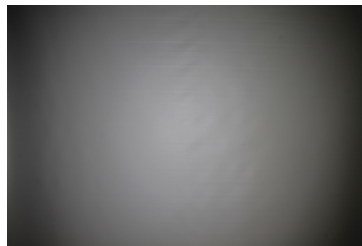

PHOTOMETRIC DATA (MEASURED):



LED LUXEON CoB 1825
FWHM 72.0°
Efficiency 93 %
Peak intensity 0.600 cd/lm
Required components:

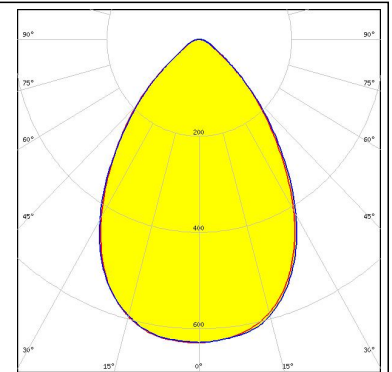

LED CXM-18
FWHM 80.0°
Efficiency 93 %
Peak intensity 0.600 cd/lm
Required components:

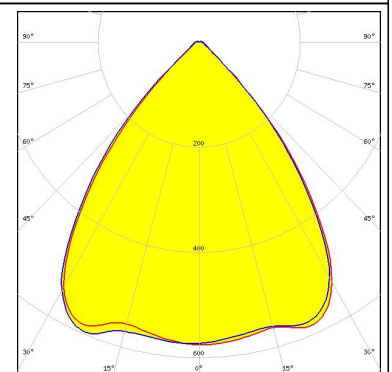

LED CXM-22
FWHM 73.0°
Efficiency 93 %
Peak intensity 0.700 cd/lm
Required components:

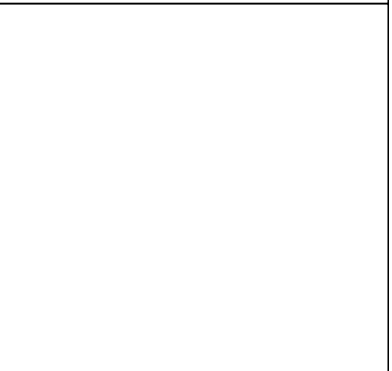
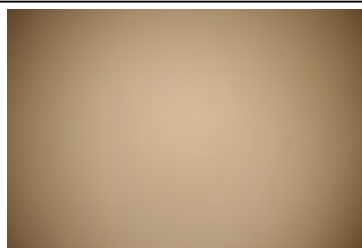

LED COB H-Type
FWHM 74.0°
Efficiency 94 %
Peak intensity 0.670 cd/lm
Required components:

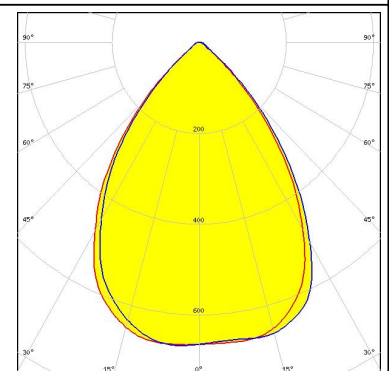
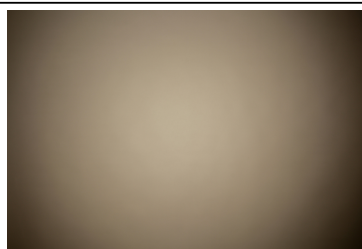

PHOTOMETRIC DATA (MEASURED):



LED COB J-Type
 FWHM 84.0°
 Efficiency 94 %
 Peak intensity 0.570 cd/lm
 Required components:

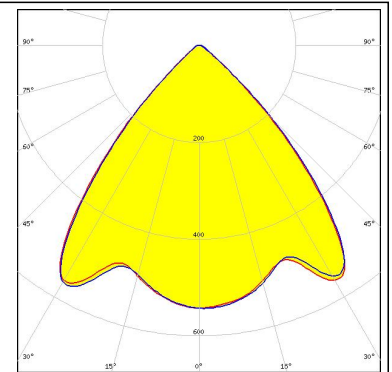
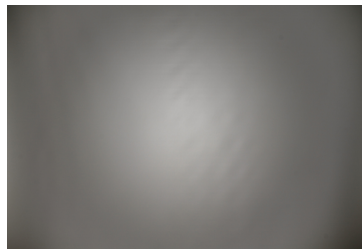

LED Soleriq S19
 FWHM 84.0°
 Efficiency 92 %
 Peak intensity 0.570 cd/lm
 Required components:

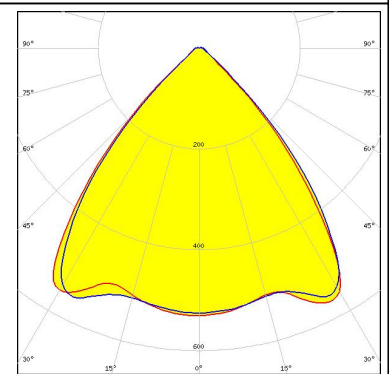

LED COB D Series LES 14.5 mm
 FWHM 83.0°
 Efficiency 93 %
 Peak intensity 0.570 cd/lm
 Required components:

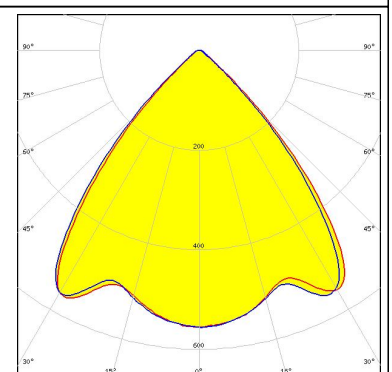
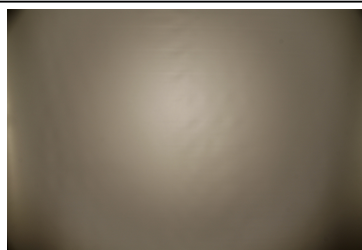

LED COB D Series LES 22 mm
 FWHM 77.0°
 Efficiency 93 %
 Peak intensity 0.630 cd/lm
 Required components:

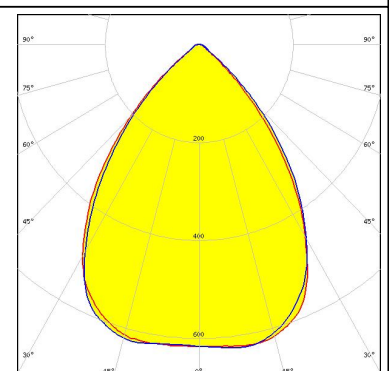
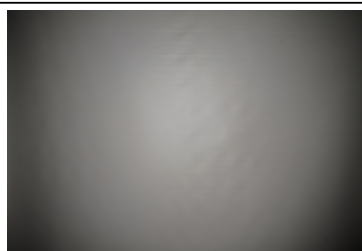

PHOTOMETRIC DATA (MEASURED):



PHOTOMETRIC DATA (SIMULATED):

bridgelux

LED V22 Gen7
FWHM 68.0°
Efficiency 94 %
Peak intensity 0.853 cd/lm
Required components:
Bender Wirth: 431 Typ L4

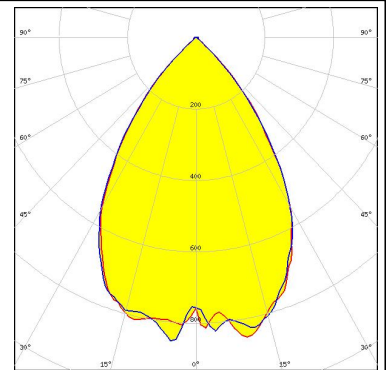

CREE

LED CMA3090
FWHM 73.0°
Efficiency 94 %
Peak intensity 0.760 cd/lm
Required components:

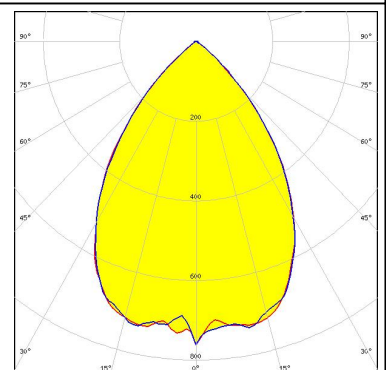

TRIDONIC

LED SLE G6 LES19
FWHM 76.0°
Efficiency 94 %
Peak intensity 0.760 cd/lm
Required components:
Bender Wirth: 466 Typ L4

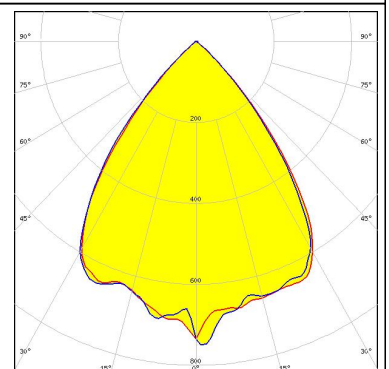

GENERAL INFORMATION:

NOTE: The typical beam angle will be changed by different color, chip size and chip position tolerance. The typical total beam angle is the full angle measured where the luminous intensity is half of the peak value.

Due to use of high power COB's with this product, special attention to proper thermal design is highly recommended. LEDiL has no liability for direct, indirect or consecutive damages arising from the LEDiL products being used outside of the recommended temperature range.

MATERIALS:

As part of our continuous research and improvement processes, and to ensure the best possible quality and availability of our products, LEDiL reserves the right to change material grades without notice.

PRODUCT DATA USER AGREEMENT AND DISCLAIMER:

The measured data in the provided downloadable LEDiL Product Datasheets and Mechanical 2D-Drawings is rounded and provided as reference for planning. LEDiL Oy's optical specifications have been verified by conducting performance testing of the products in accordance with the company's quality system. The reported data are averaged results of multiple measurements with typical variation. LEDiL Oy reserves the right to without prior notification make changes and improvements to its products.

LEDiL Oy assumes neither warranty, nor guarantee nor any other liability of any kind for the contents and correctness of the provided data. The provided data has been generated with highest diligence but the provided data may in reality not represent the complete possible variation range of all intrinsic parameters. Therefore, in certain cases a deviation from the provided data could occur.

LEDiL Oy reserves the right to undertake technical changes of its products without further notification which could lead to changes in the provided data. LEDiL Oy assumes no liability of any kind for the possible deviation from any provided data or any other damage resulting from the usage of the provided data.

The user agrees to this disclaimer and user agreement with the download or usage of the provided files.

LEDiL Oy

Joensuunkatu 13
FI-24240 SALO
Finland

LEDiL Inc.

228 West Page Street
Suite D
Sycamore IL 60178
USA

Local sales and technical support

www.ledil.com/where_to_buy

Shipping locations

Salo, Finland
Hong Kong, China

Distribution Partners

www.ledil.com/where_to_buy