



Is Now Part of



ON Semiconductor®

To learn more about ON Semiconductor, please visit our website at
www.onsemi.com

ON Semiconductor and the ON Semiconductor logo are trademarks of Semiconductor Components Industries, LLC dba ON Semiconductor or its subsidiaries in the United States and/or other countries. ON Semiconductor owns the rights to a number of patents, trademarks, copyrights, trade secrets, and other intellectual property. A listing of ON Semiconductor's product/patent coverage may be accessed at www.onsemi.com/site/pdf/Patent-Marking.pdf. ON Semiconductor reserves the right to make changes without further notice to any products herein. ON Semiconductor makes no warranty, representation or guarantee regarding the suitability of its products for any particular purpose, nor does ON Semiconductor assume any liability arising out of the application or use of any product or circuit, and specifically disclaims any and all liability, including without limitation special, consequential or incidental damages. Buyer is responsible for its products and applications using ON Semiconductor products, including compliance with all laws, regulations and safety requirements or standards, regardless of any support or applications information provided by ON Semiconductor. "Typical" parameters which may be provided in ON Semiconductor data sheets and/or specifications can and do vary in different applications and actual performance may vary over time. All operating parameters, including "Typicals" must be validated for each customer application by customer's technical experts. ON Semiconductor does not convey any license under its patent rights nor the rights of others. ON Semiconductor products are not designed, intended, or authorized for use as a critical component in life support systems or any FDA Class 3 medical devices or medical devices with a same or similar classification in a foreign jurisdiction or any devices intended for implantation in the human body. Should Buyer purchase or use ON Semiconductor products for any such unintended or unauthorized application, Buyer shall indemnify and hold ON Semiconductor and its officers, employees, subsidiaries, affiliates, and distributors harmless against all claims, costs, damages, and expenses, and reasonable attorney fees arising out of, directly or indirectly, any claim of personal injury or death associated with such unintended or unauthorized use, even if such claim alleges that ON Semiconductor was negligent regarding the design or manufacture of the part. ON Semiconductor is an Equal Opportunity/Affirmative Action Employer. This literature is subject to all applicable copyright laws and is not for resale in any manner.

SG6520A PC Power Supply Supervisors

Features

- Two 12V Sense Input Pins: VS12 and VS12B
- Over-Voltage Protection (OVP) for 3.3V, 5V, and Two 12V
- Over-Current Protection (OCP) for 3.3V, 5V, and Two 12V
- Under-Voltage Protection (UVP) for 3.3V, 5V, and Two 12V
- Open-Drain Output for PGO and FPO Pins
- 300ms Power-Good Delay
- 2.8ms PSON Control to FPO Turn-off Delay
- 48ms PSON Control Delay
- No Lock-up During the Fast AC Power On/Off
- Wide Supply Voltage Range: 4V to 15V
- Over-Temperature Protection (OTP)

Applications

- Switch-Mode Power Supplies with Active PFC
- Servo System Power Supplies
- PC-ATX Power Supplies

Description

The SG6520A is designed to provide the supply voltage, current supervisor, remote on/off (PSON), power good (PGO) indicator, and fault protection (FPO) functions for switching power systems.

For supervisory functions, it provides the over-voltage protection (OVP) for 3.3V, 5V, and two 12V; over-current protection (OCP) for 3.3V, 5V, and two 12V; under-voltage protection (UVP) for 3.3V, 5V, and two 12V. When 3.3V, 5V, or 12V voltage decreases to 2.3V, 3.5V, and 9V, respectively, the under-voltage protection function is enabled. FPO is set HIGH to turn off the PWM controller IC. The voltage difference across the external current shunt is used for OCP functions. An external resistor can be used to adjust protection threshold. An additional protection input pin provides the flexibility for designing protection circuits.

The power supply is turned on after a 48ms delay when PSON signal is set from HIGH to LOW. To turn off the power supply, the PSON signal is set from LOW to HIGH with a delay of 48ms. The PGI circuitry provides a power-down warning signal for PGO. When PGI input is lower than the internal 1.25V reference voltage, the PGO signal is pulled LOW.

Ordering Information

| Part Number | Operating Temperature Range |  Eco Status | Package | Packing Method |
|-------------|-----------------------------|--|-----------------------------------|----------------|
| SG6520ADY | -40°C to +85°C | Green | 16-pin Dual In-Line Package (DIP) | Tube |

 For Fairchild's definition of "green" Eco Status, please visit: http://www.fairchildsemi.com/company/green/rohs_green.html.

Block Diagram

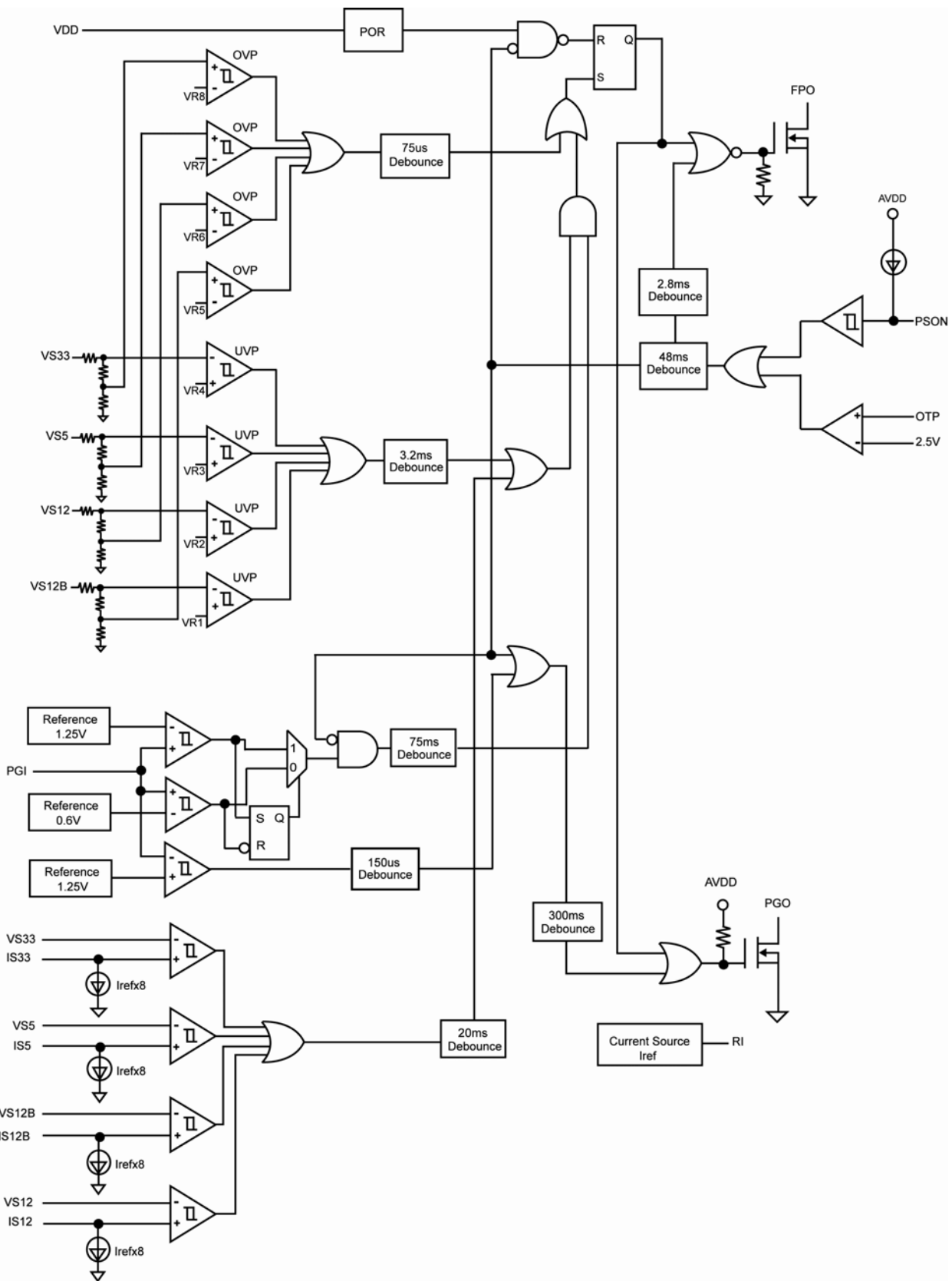
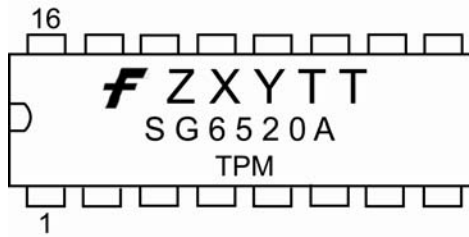

Figure 2. Function Block Diagram

Marking Information



- F* – Fairchild logo
- Z* – Plant code
- X* – 1 digit year code
- Y* – 1 digit week code
- TT* – 2 digits die run code
- T* – Package type (D:DIP)
- P* – Z:Pb free, Y:Green package
- M* – Manufacture flow code

Figure 3. Top Mark

Pin Configuration

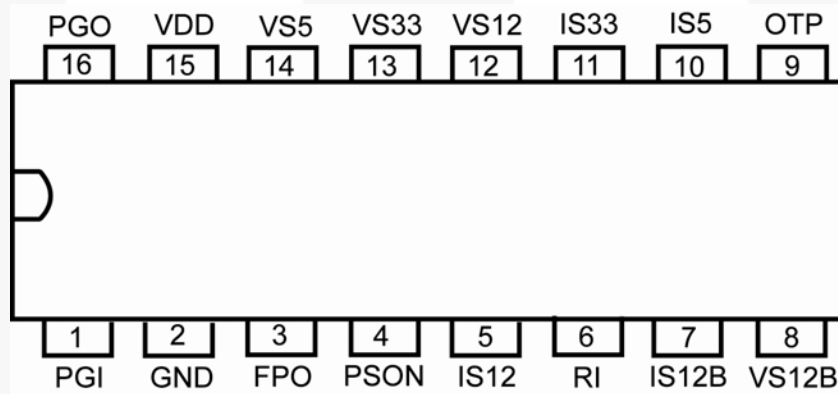

Figure 4. Pin Configuration (Top View)

Pin Definitions

| Pin # | Name | Description |
|-------|-------|---|
| 1 | PGI | Power good input. For ATX SMPS, it detects AC line voltage through the main transformer. |
| 2 | GND | Ground. |
| 3 | FPO | Fault protection output. Output signal to control the primary PWM IC through an opto-coupler. When FPO is low, the PWM IC is enabled. |
| 4 | PSON | Remote on/off logic input from CPU or main board. The power supply is turned on/off after a 48ms delay. |
| 5 | IS12 | 12V over-current protection sense input. For typical applications, this pin is connected to the positive end of a current shunt through one resistor. When the voltage on IS12 is higher than that of VS12 by 5mV, OCP is enabled. |
| 6 | RI | Reference setting. One external resistor RI connected between the RI and GND pins determines a reference current, $I_{REF} = 1.25/R_i$, for OCP programming. |
| 7 | IS12B | 12V over-current protection sense input. For typical application, this pin is connected to the positive end of a current shunt through one resistor. When the voltage on IS12 is higher than that of VS12 by 5mV, OCP is enabled. |
| 8 | VS12B | Second 12V over/under-voltage control sense input. |
| 9 | OTP | Over-temperature protection. |
| 10 | IS5 | 5V over-current protection sense input. |
| 11 | IS33 | 3.3V over-current protection sense input. |
| 12 | VS12 | 12V over/under-voltage control sense input. |
| 13 | VS33 | 3.3V over/under-voltage control sense input. |
| 14 | VS5 | 5V over/under-voltage control sense input. |
| 15 | VDD | Supply voltage: 4.2V ~ 15V. For ATX SMPS, it is connected to 5V-standby and 12V through diodes, respectively. |
| 16 | PGO | Power-good logic output, 0 or 1 (open-drain). Power good=1 means that the power supply is good for operation. The power good delay is 300ms. |

Absolute Maximum Ratings

Stresses exceeding the absolute maximum ratings may damage the device. The device may not function or be operable above the recommended operating conditions and stressing the parts to these levels is not recommended. In addition, extended exposure to stresses above the recommended operating conditions may affect device reliability. The absolute maximum ratings are stress ratings only.

| Symbol | Parameter | | Min. | Max. | Unit |
|------------------|---|--------------------------------------|------|------|------|
| V _{DD} | DC Supply Voltage ^(1, 2) | | | 16 | V |
| V _{IN} | Input Voltage | PSON, PGI, VS5, IS5, VS33, IS33, OTP | -0.3 | 7.0 | V |
| | | VS12, VS12B, IS12, IS12B | -0.3 | 15.0 | V |
| V _{OUT} | Output Voltage | FPO, PGO | -0.3 | 7.0 | V |
| T _J | Operating Junction Temperature | | -40 | +125 | °C |
| T _{STG} | Storage Temperature Range | | -55 | +150 | °C |
| T _L | Lead Temperature (Soldering) | | | +260 | °C |
| ESD | Electrostatic Discharge Capability, Human Body Model, JESD22-A114 | | | 3.0 | KV |
| | Electrostatic Discharge Capability, Machine Model, JESD22-A115 | | | 200 | V |

Notes:

- All voltage values, except differential voltage, are given with respect to GND pin.
- Stresses beyond those listed under “absolute maximum ratings” may cause permanent damage to the device.

Recommended Operating Conditions

The Recommended Operating Conditions table defines the conditions for actual device operation. Recommended operating conditions are specified to ensure optimal performance to the datasheet specifications. Fairchild does not recommend exceeding them or designing to Absolute Maximum Ratings.

| Symbol | Parameter | Min. | Typ. | Max. | Unit |
|----------------|-------------------------------|------|------|------|------|
| T _A | Operating Ambient Temperature | -40 | | +85 | °C |

Electrical Characteristics

$V_{DD} = 5V$, $T_A = 25^\circ C$, unless otherwise noted.

| Symbol | Parameter | Conditions | Min. | Typ. | Max. | Units |
|--|--|---|-----------|-------|-----------|---------|
| V_{DD} Section | | | | | | |
| V _{DD} | DC Supply Voltage | | 4.2 | | 15.0 | V |
| I _{DD1} | Supply Current | PSON = LOW | | 1.7 | 2.6 | mA |
| I _{DD2} | Supply Current | PSON = HIGH | | 1.0 | 1.5 | mA |
| t _R | Supply Voltage Rising Time | | 1 | | | ms |
| V _{ST} | V _{DD} Start Threshold Voltage | | | | 4.2 | V |
| Over-Voltage (OVP) and Over-Current (OCP) Protections | | | | | | |
| V _{OVP} | Over-Voltage Protection | VS33 | 3.830 | 3.965 | 4.100 | V |
| | | VS5 | 5.80 | 6.15 | 6.50 | |
| | | VS12, VS12B | 13.70 | 14.05 | 14.40 | |
| I _{REF} | Ratio of Current-Sense Sink Current to Current-Sense Setting Pin (RI) Source Current | R _i = 18.5k Ω ~ 75k Ω (temperature = -40 $^\circ$ C ~ +80 $^\circ$ C) | 7.80 | 8.05 | 8.30 | |
| V _{OFFSET} | OCP Comparator Input Offset Voltage | | -3 | | 3 | mV |
| I _{LKG-FPO} | Leakage Current (FPO) | FPO = 5V | | | 5 | μ A |
| V _{OL-FPO} | Low-Level Output Voltage (FPO) | I _{SINK} 20mA | | | 0.4 | V |
| t _{OVP} | OVP Delay Time | | 33 | 75 | 110 | μ s |
| t _{OCP} | OCP Delay Time | | 12.5 | 20.0 | 27.5 | ms |
| V _{RI} | RI Pin Voltage | | 0.98•Typ. | 1.25 | 1.01•Typ. | V |
| I _{RI} | Output Current RI | | 12.5 | | 62.5 | μ A |
| t _{ST-OCP} | Start-up OCP / UVP Protection Time | 0.6V < PGI < 1.25V; FPO = Low | 49 | 75 | 114 | ms |
| Under-Voltage Protection and PGI, PGO | | | | | | |
| V _{PGI_1} | Input Threshold Voltage | PGI 1 | 0.98•Typ. | 1.25 | 1.02•Typ. | V |
| V _{PGI_2} | Input Threshold Voltage | PGI 2 | 0.96•Typ. | 0.60 | 1.03•Typ. | V |
| V _{UVP} | Under-Voltage Protection | VS33 | 2.65 | 2.80 | 2.95 | V |
| | | VS5 | 3.7 | 4.1 | 4.5 | |
| | | VS12, VS12B | 9.2 | 10.0 | 10.8 | |
| t _{OND} | Under-Voltage Turn-on Delay | PGI > 0.6V | 49 | 75 | 114 | ms |
| t _{UVP} | UVP Delay | PGI > 1.25V | 2.4 | 3.2 | 4.0 | ms |
| I _{LKG-PGO} | Leakage Current (PGO) | PGO = 5V | | | 5 | μ A |
| V _{OL-PGO} | Low-Level Output Voltage (PGO) | V _{DD} = 12V; I _{SINK} 10mA | | | 0.4 | V |
| t _{PG} | Timing PG Delay | | 200 | 300 | 450 | ms |
| t _{ND1} | Noise Deglitch Time | | 90 | 150 | 210 | μ s |
| PSON Control | | | | | | |
| I _{PSON} | Input Pull-up Current | PSON = 0V | | 120 | | μ A |
| V _{IH} | High-Level Input Voltage | | 2 | | | V |
| V _{IL} | Low-Level Input Voltage | | | | 0.8 | V |
| t _{PSON} | Timing PSON to On/Off | PSON LOW to FPO LOW | 34 | 48 | 67 | ms |
| | | PSON HIGH to PGO LOW | 34 | 48 | 67 | |
| t _{PSOFF} | Timing PGO LOW to FPO HIGH | | 1.6 | 2.8 | 4.5 | ms |
| Over-Temperature Section | | | | | | |
| V _{TH} | Over-Temperature Threshold | | 2.4 | 2.5 | 2.6 | V |
| V _{HYST} | Hysteresis | | 0.18 | | 0.23 | V |

Functional Description

The SG6520A provides over-current protection for the 3.3V, 5V, and two 12V rails. Whenever an OCP condition occurs at any of the voltage rails, PGO is LOW and FPO is open. The internal OCP comparators have a very small offset voltage ($\pm 3\text{mV}$). The sink currents of IS33, IS5, and IS12 are eight times the current at the RI pin. The current at the RI pin is V_{RI}/R_I .

Here is an example demonstrating how to set the over current protection. If $I_1 \times R_1 > I_{RI} \times R_2$, OCP is active. If $R_1 = 5\text{m}\Omega$, $R_I = 30\text{K}\Omega$, and the OCP active level is 35A, the R_2 resistor is:

$$R_2 = \frac{I_1 \times R_1}{I_{RI} \times 8} = 525\Omega \quad (1)$$

where C is bypass noise; suggested value is between $1\mu\text{F} \sim 2.2\mu\text{F}$.

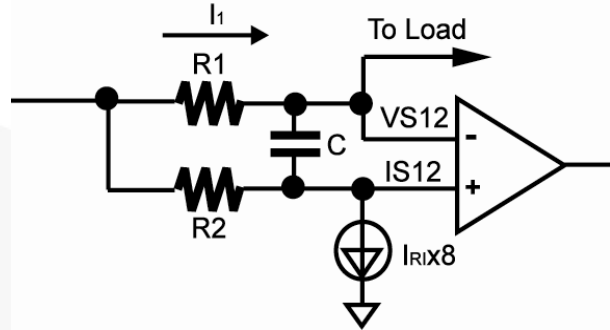

Figure 5. OCP Set Up

Timing Chart

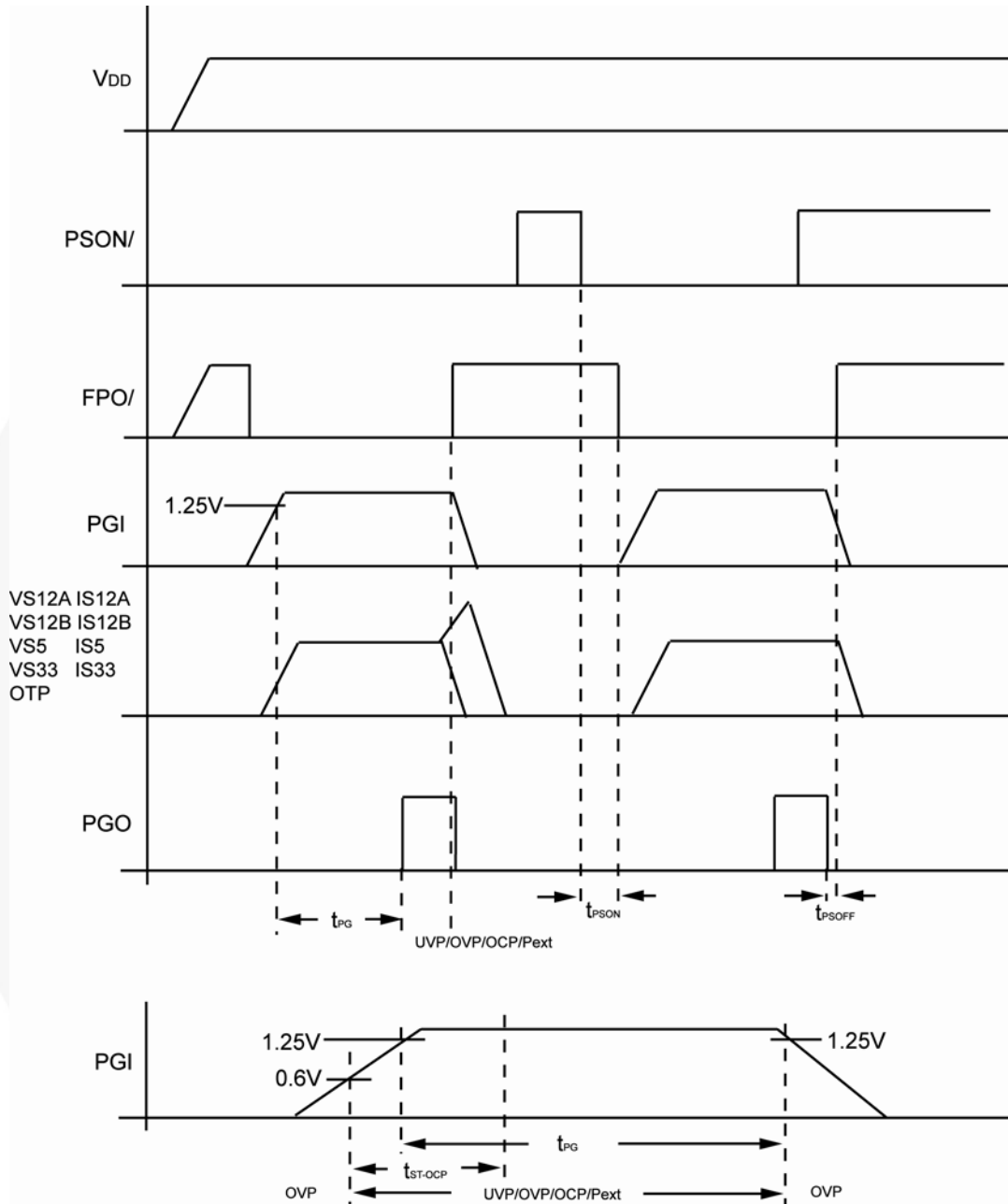

Figure 6. Timing Diagram

Typical Performance Characteristics

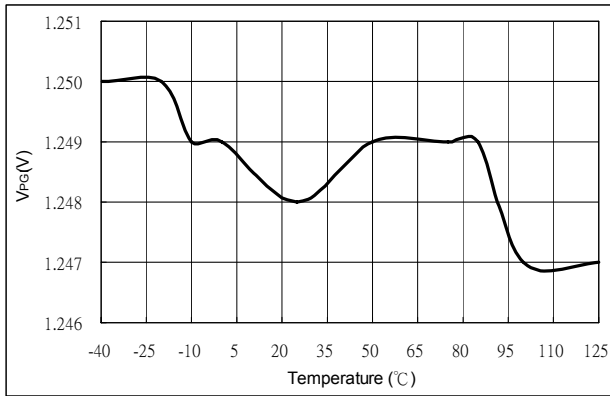

Figure 7. V_{PG1} vs. T_A

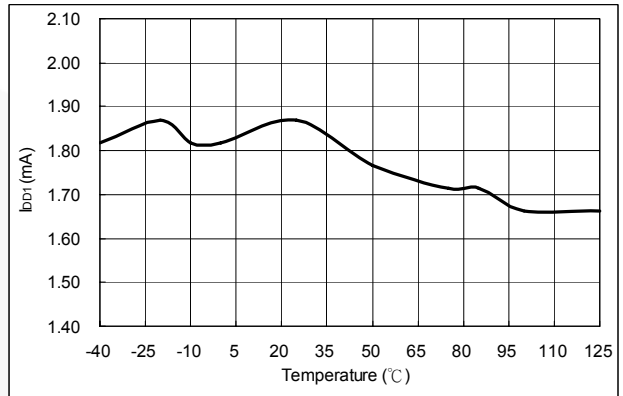

Figure 8. I_{D1} vs. T_A

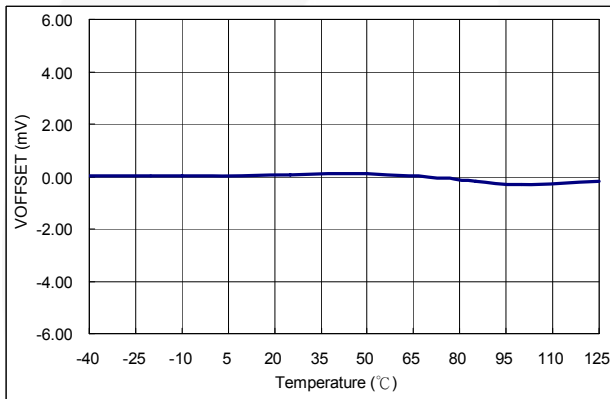

Figure 9. V_{OFFSET} vs. T_A

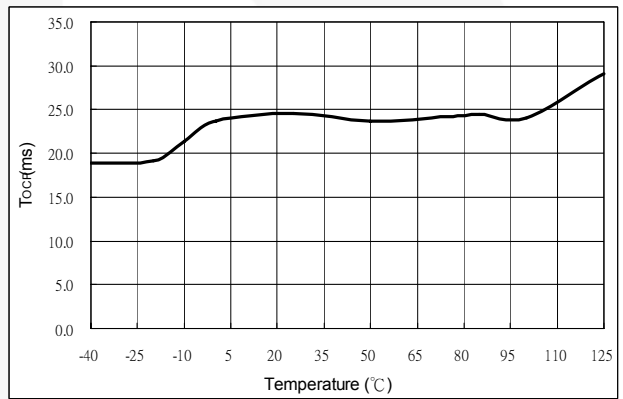

Figure 10. T_{OCP} vs. T_A

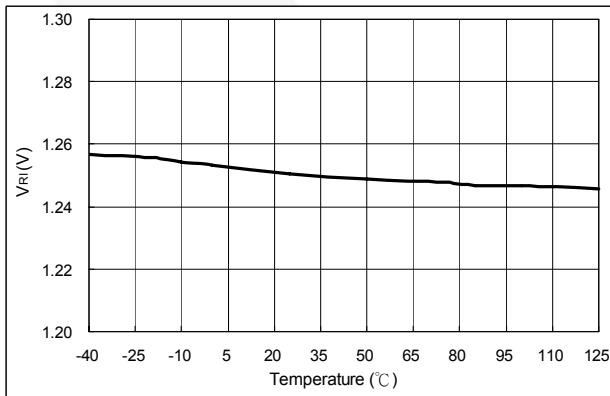







Figure 11. V_{R1} vs. T_A



TRADEMARKS

The following includes registered and unregistered trademarks and service marks, owned by Fairchild Semiconductor and/or its global subsidiaries, and is not intended to be an exhaustive list of all such trademarks.

- | | | | |
|---|---|---|---|
| Build it Now™ | F-PFS™ | PowerTrench® | The Power Franchise® |
| CorePLUS™ | FRFET® | Programmable Active Droop™ | the power franchise |
| CorePOWER™ | Global Power Resource SM | QFET® | TinyBoost™ |
| CROSSVOLT™ | Green FPS™ | QS™ | TinyBuck™ |
| CTL™ | Green FPS™ e-Series™ | Quiet Series™ | TinyLogic® |
| Current Transfer Logic™ | GTO™ | RapidConfigure™ | TINYOPTO™ |
| EcoSPARK® | IntelliMAX™ |  ™ | TinyPower™ |
| EfficientMax™ | ISOPLANAR™ | Saving our world, 1mW/W/kW at a time™ | TinyPWM™ |
| EZSWITCH™* | MegaBuck™ | SmartMax™ | TinyWire™ |
|  ™ | MICROCOUPLER™ | SMART START™ | µSerDes™ |
|  ™ | MicroFET™ | SPM® |  |
| Fairchild® | MicroPak™ | STEALTH™ | UHC® |
| Fairchild Semiconductor® | MillerDrive™ | SuperFET™ | Ultra FRFET™ |
| FACT Quiet Series™ | MotionMax™ | SuperSOT™-3 | UniFET™ |
| FACT® | Motion-SPM™ | SuperSOT™-6 | VCX™ |
| FAST® | OPTOLOGIC® | SuperSOT™-8 | VisualMax™ |
| FastvCore™ | OPTOPLANAR® | SupreMOS™ | |
| FlashWriter®* |  ™ | SyncFET™ | |
| FPS™ | PDP µPM™ |  | |
| | Power-SPM™ | | |

* EZSWITCH™ and FlashWriter® are trademarks of System General Corporation, used under license by Fairchild Semiconductor.

DISCLAIMER

FAIRCHILD SEMICONDUCTOR RESERVES THE RIGHT TO MAKE CHANGES WITHOUT FURTHER NOTICE TO ANY PRODUCTS HEREIN TO IMPROVE RELIABILITY, FUNCTION, OR DESIGN. FAIRCHILD DOES NOT ASSUME ANY LIABILITY ARISING OUT OF THE APPLICATION OR USE OF ANY PRODUCT OR CIRCUIT DESCRIBED HEREIN; NEITHER DOES IT CONVEY ANY LICENSE UNDER ITS PATENT RIGHTS, NOR THE RIGHTS OF OTHERS. THESE SPECIFICATIONS DO NOT EXPAND THE TERMS OF FAIRCHILD'S WORLDWIDE TERMS AND CONDITIONS, SPECIFICALLY THE WARRANTY THEREIN, WHICH COVERS THESE PRODUCTS.

LIFE SUPPORT POLICY

FAIRCHILD'S PRODUCTS ARE NOT AUTHORIZED FOR USE AS CRITICAL COMPONENTS IN LIFE SUPPORT DEVICES OR SYSTEMS WITHOUT THE EXPRESS WRITTEN APPROVAL OF FAIRCHILD SEMICONDUCTOR CORPORATION.

As used herein:

- Life support devices or systems are devices or systems which, (a) are intended for surgical implant into the body or (b) support or sustain life, and (c) whose failure to perform when properly used in accordance with instructions for use provided in the labeling, can be reasonably expected to result in a significant injury of the user.
- A critical component in any component of a life support device, or system whose failure to perform can be reasonably expected to cause the failure of the life support device or system, or to affect its safety or effectiveness.

ANTI-COUNTERFEITING POLICY

Fairchild Semiconductor Corporation's Anti-Counterfeiting Policy. Fairchild's Anti-Counterfeiting Policy is also stated on our external website, www.fairchildsemi.com, under Sales Support.

Counterfeiting of semiconductor parts is a growing problem in the industry. All manufacturers of semiconductor products are experiencing counterfeiting of their parts. Customers who inadvertently purchase counterfeit parts experience many problems such as loss of brand reputation, substandard performance, failed applications, and increased cost of production and manufacturing delays. Fairchild is taking strong measures to protect ourselves and our customers from the proliferation of counterfeit parts. Fairchild strongly encourages customers to purchase Fairchild parts either directly from Fairchild or from Authorized Fairchild Distributors who are listed by country on our web page cited above. Products customers buy either from Fairchild directly or from Authorized Fairchild Distributors are genuine parts, have full traceability, meet Fairchild's quality standards for handling and storage and provide access to Fairchild's full range of up-to-date technical and product information. Fairchild and our Authorized Distributors will stand behind all warranties and will appropriately address any warranty issues that may arise. Fairchild will not provide any warranty coverage or other assistance for parts bought from Unauthorized Sources. Fairchild is committed to combat this global problem and encourage our customers to do their part in stopping this practice by buying direct or from authorized distributors.

PRODUCT STATUS DEFINITIONS

Definition of Terms

| Datasheet Identification | Product Status | Definition |
|--------------------------|-----------------------|---|
| Advance Information | Formative / In Design | Datasheet contains the design specifications for product development. Specifications may change in any manner without notice. |
| Preliminary | First Production | Datasheet contains preliminary data; supplementary data will be published at a later date. Fairchild Semiconductor reserves the right to make changes at any time without notice to improve design. |
| No Identification Needed | Full Production | Datasheet contains final specifications. Fairchild Semiconductor reserves the right to make changes at any time without notice to improve the design. |
| Obsolete | Not In Production | Datasheet contains specifications on a product that is discontinued by Fairchild Semiconductor. The datasheet is for reference information only. |

Rev. 136

ON Semiconductor and  are trademarks of Semiconductor Components Industries, LLC dba ON Semiconductor or its subsidiaries in the United States and/or other countries. ON Semiconductor owns the rights to a number of patents, trademarks, copyrights, trade secrets, and other intellectual property. A listing of ON Semiconductor's product/patent coverage may be accessed at www.onsemi.com/site/pdf/Patent-Marking.pdf. ON Semiconductor reserves the right to make changes without further notice to any products herein. ON Semiconductor makes no warranty, representation or guarantee regarding the suitability of its products for any particular purpose, nor does ON Semiconductor assume any liability arising out of the application or use of any product or circuit, and specifically disclaims any and all liability, including without limitation special, consequential or incidental damages. Buyer is responsible for its products and applications using ON Semiconductor products, including compliance with all laws, regulations and safety requirements or standards, regardless of any support or applications information provided by ON Semiconductor. "Typical" parameters which may be provided in ON Semiconductor data sheets and/or specifications can and do vary in different applications and actual performance may vary over time. All operating parameters, including "Typicals" must be validated for each customer application by customer's technical experts. ON Semiconductor does not convey any license under its patent rights nor the rights of others. ON Semiconductor products are not designed, intended, or authorized for use as a critical component in life support systems or any FDA Class 3 medical devices or medical devices with a same or similar classification in a foreign jurisdiction or any devices intended for implantation in the human body. Should Buyer purchase or use ON Semiconductor products for any such unintended or unauthorized application, Buyer shall indemnify and hold ON Semiconductor and its officers, employees, subsidiaries, affiliates, and distributors harmless against all claims, costs, damages, and expenses, and reasonable attorney fees arising out of, directly or indirectly, any claim of personal injury or death associated with such unintended or unauthorized use, even if such claim alleges that ON Semiconductor was negligent regarding the design or manufacture of the part. ON Semiconductor is an Equal Opportunity/Affirmative Action Employer. This literature is subject to all applicable copyright laws and is not for resale in any manner.

PUBLICATION ORDERING INFORMATION

LITERATURE FULFILLMENT:

Literature Distribution Center for ON Semiconductor
19521 E. 32nd Pkwy, Aurora, Colorado 80011 USA
Phone: 303-675-2175 or 800-344-3860 Toll Free USA/Canada
Fax: 303-675-2176 or 800-344-3867 Toll Free USA/Canada
Email: orderlit@onsemi.com

N. American Technical Support: 800-282-9855 Toll Free
USA/Canada
Europe, Middle East and Africa Technical Support:
Phone: 421 33 790 2910
Japan Customer Focus Center
Phone: 81-3-5817-1050

ON Semiconductor Website: www.onsemi.com
Order Literature: <http://www.onsemi.com/orderlit>
For additional information, please contact your local
Sales Representative