

THIS DOCUMENT IS THE PROPERTY OF
KEYSTONE ELECTRONICS CORP. AND
SHALL NOT BE REPRODUCED, DISTRIBUTED
OR USED AS A BASIS FOR MANUFACTURE
WITHOUT PRIOR WRITTEN PERMISSION
FROM KEYSTONE ELECTRONICS CORP.

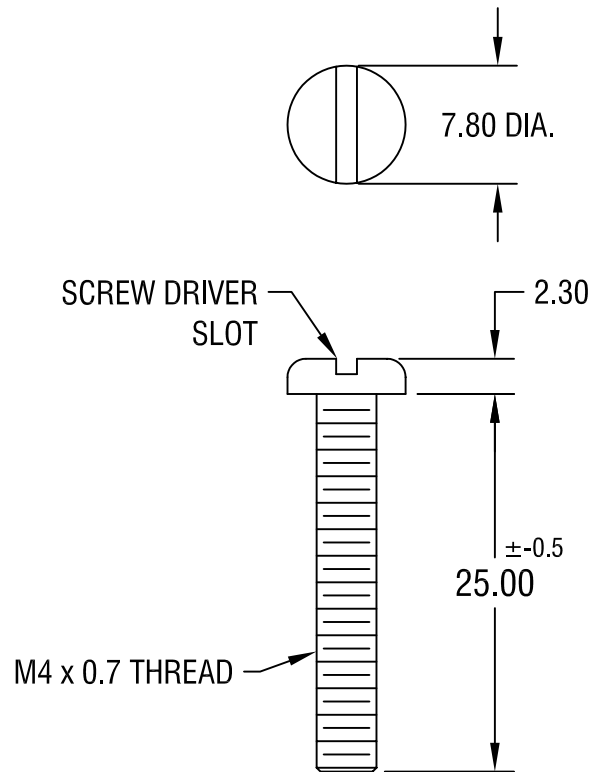

NOTE:

1. ALL DIMENSIONS ARE IN MILLIMETERS

KEYSTONE ELECTRONICS CORP.			
ASTORIA, N.Y. 11105-2017			
PART NAME		M4 PAN HEAD SCREW	
MATERIAL		NYLON 6/6 UL 94V-2	
FINISH	-	DRN BY	BOONE
		APP'D	LN
		DATE	10.12.06
		SCALE	2X
TOLERANCES	INCH [MM]	CODE	DWG NO.
DECIMAL	± [± 0.25]	C/M	29358
ANGULAR	± 1°		
UNLESS OTHERWISE SPECIFIED			

DATE	DESCRIPTION	REV.