

click™

USB adapter

Connect the desired Click™ additional board directly to your PC via USB cable. No micro-controllers required.

TO OUR VALUED CUSTOMERS

I want to express my thanks to you for being interested in our products and for having confidence in MikroElektronika.

The primary aim of our company is to design and produce high quality electronic products and to constantly improve the performance thereof in order to better suit your needs.

A handwritten signature in white ink, appearing to read 'N. Matic', is positioned on the right side of the page. The signature is fluid and cursive, with a large initial 'N' and 'M'.

Nebojsa Matic
General Manager

Table of Contents

Introduction	4
Schematic	5
Install drivers before use	6
Click boards are plug and play!	7
Dimensions	8
Disclaimer	11

Introduction

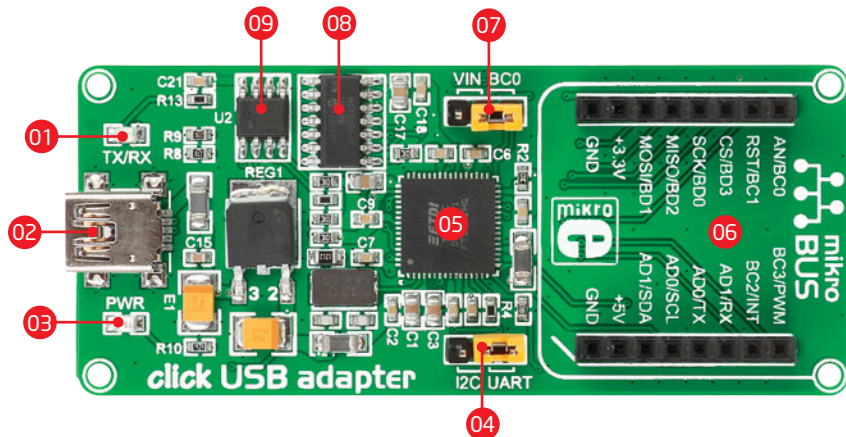

- 01 TX/RX indication LED
- 02 USB MINI-B connector
- 03 Power indication LED
- 04 I²C/UART jumper (J1)
- 05 FT2232H IC
- 06 mikroBUS™ socket
- 07 VIN/BC0 jumper (J2)
- 08 MCP3204 ADC converter
- 09 EEPROM memory

Click USB adapter board provides necessary interface for connecting Click™ add-on boards to your PC through high speed USB connection. There is no need to use a microcontroller. It features **FT2232H** dual high speed USB to multipurpose IC, Analog-to-Digital converter, EEPROM memory and a single mikroBUS™ host socket. **FT2232H** provides necessary communication lines defined by the mikroBUS™ standard. mikroBUS™ host connector consists of two 1x8 female headers with **SPI** (MOSI, MISO, SCK, CS), **I²C** (SDA,

SCL), **UART** (Tx, Rx), **RST**, **PWM**, **Analog** and **Interrupt** lines as well as **3.3V**, **5V** and **GND** power lines. **Click USB adapter** board can be powered through USB cable only. On-board power circuitry generates 3.3V and 5V. Two jumpers are provided on the board. **J1** jumper is used to select whether UART or I²C will be used. **J2** selects whether AN pin on mikroBUS™ socket will be just another GPIO pin, or connected to **MCP3204** AD converter circuit, thus serving for analog readings.

3.3V VOLTAGE REGULATOR

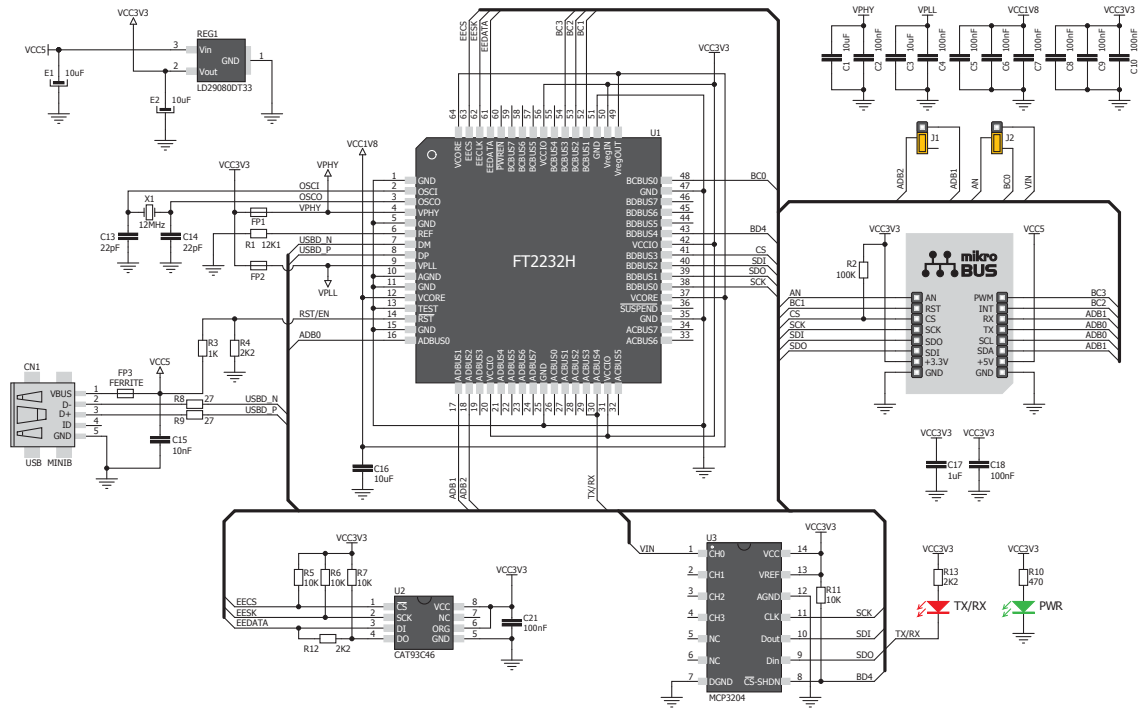

Figure 1: Click USB adapter schematic

Install drivers before use

On-board **FT232H** chip requires drivers to be installed on your PC before operation. Drivers are available on the manufacturer's website: <http://www.ftdichip.com/Drivers/VCP.htm>

Figure 2:
FT232H
controller
from FTDI® Chip

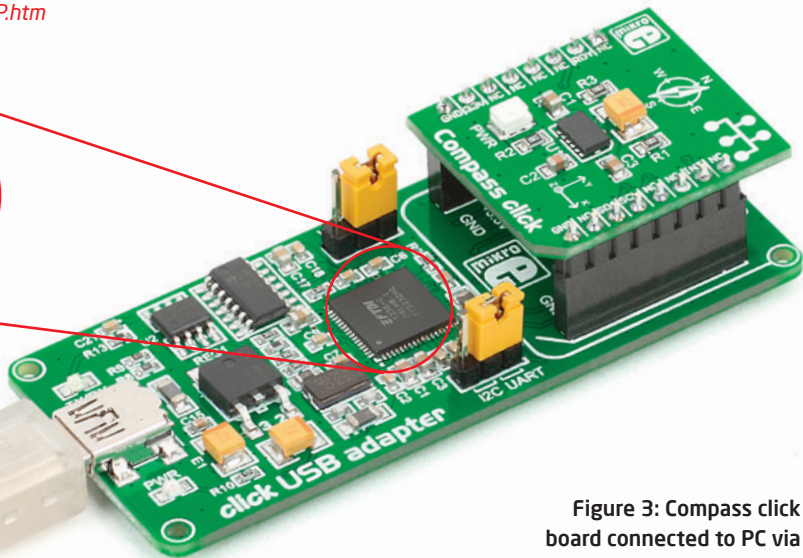
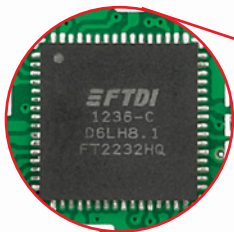
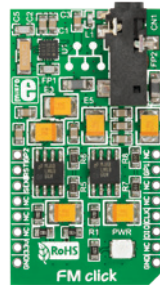

Figure 3: Compass click
board connected to PC via
click USB adapter board

Click boards are plug and play!

Up to now, MikroElektronika has released more than 60 mikroBUS™ compatible **Click Boards™**. On the average, one click board is released per week. It is our intention to provide you with as many add-on boards as possible, so you will be able to expand your development board with additional functionality. Each board comes with a set of working example codes. Please visit the Click boards™ webpage for the complete list of currently available boards:

<http://www.mikroe.com/click/>



FM click™

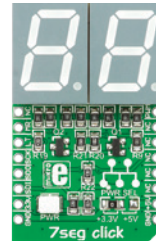

7seg click™

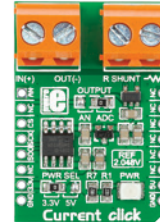

Current click™



Bluetooth2 click™

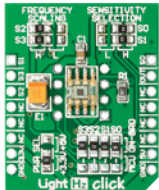

LightHz click™

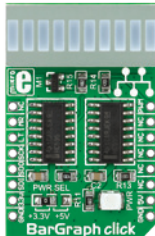

BarGraph click™

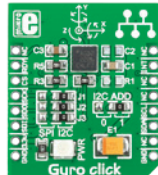

Gyro click™

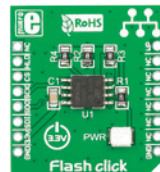

Flash click™

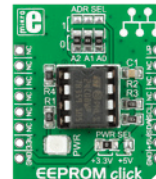

EEPROM click™



THERMO click™

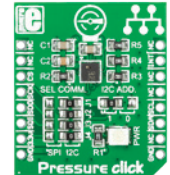

Pressure click™

Dimensions

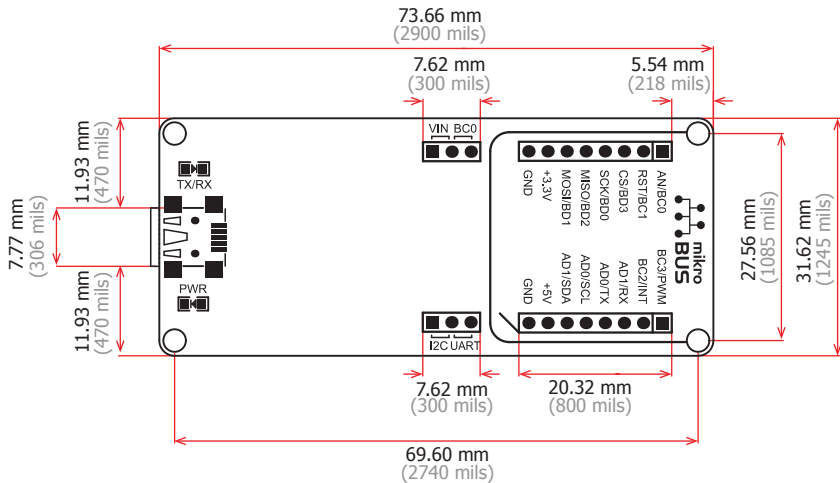

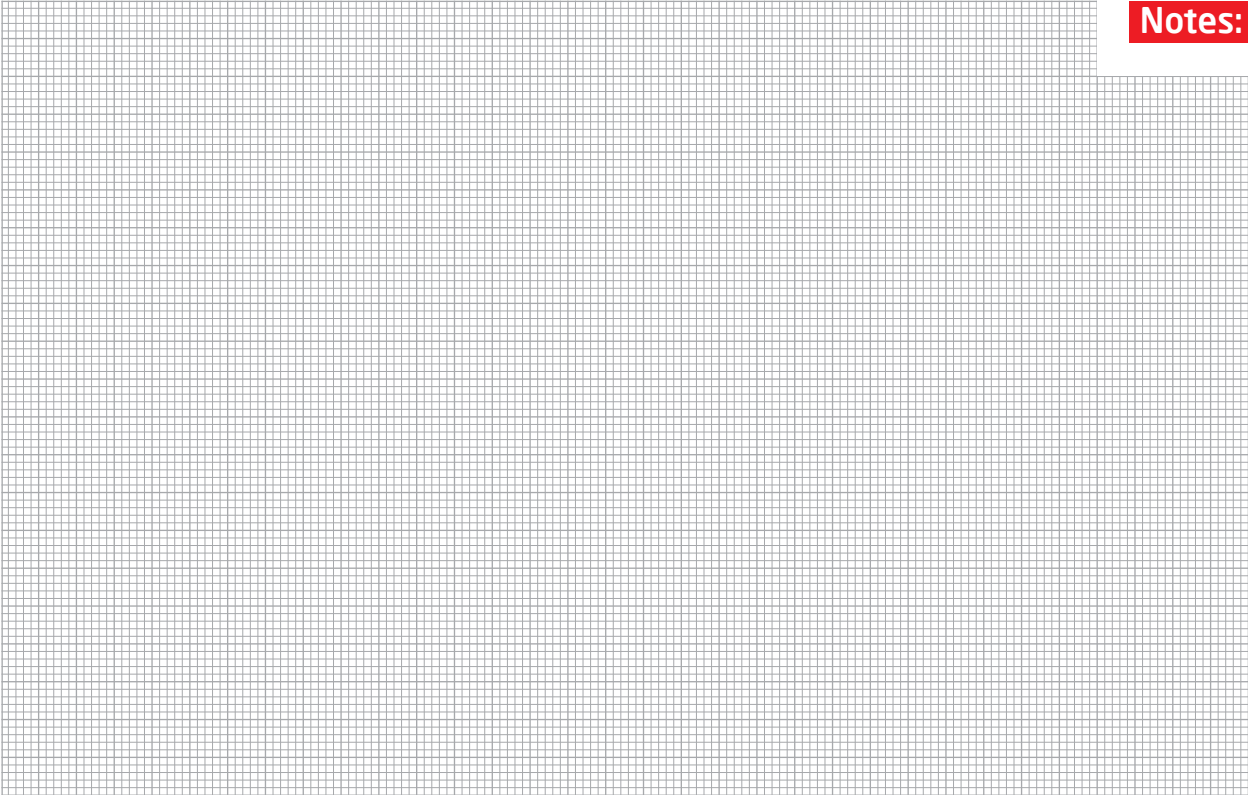

Notes:

DISCLAIMER

All the products owned by MikroElektronika are protected by copyright law and international copyright treaty. Therefore, this manual is to be treated as any other copyright material. No part of this manual, including product and software described herein, may be reproduced, stored in a retrieval system, translated or transmitted in any form or by any means, without the prior written permission of MikroElektronika. The manual PDF edition can be printed for private or local use, but not for distribution. Any modification of this manual is prohibited.

MikroElektronika provides this manual 'as is' without warranty of any kind, either expressed or implied, including, but not limited to, the implied warranties or conditions of merchantability or fitness for a particular purpose.

MikroElektronika shall assume no responsibility or liability for any errors, omissions and inaccuracies that may appear in this manual. In no event shall MikroElektronika, its directors, officers, employees or distributors be liable for any indirect, specific, incidental or consequential damages (including damages for loss of business profits and business information, business interruption or any other pecuniary loss) arising out of the use of this manual or product, even if MikroElektronika has been advised of the possibility of such damages. MikroElektronika reserves the right to change information contained in this manual at any time without prior notice, if necessary.

HIGH RISK ACTIVITIES

The products of MikroElektronika are not fault - tolerant nor designed, manufactured or intended for use or resale as on - line control equipment in hazardous environments requiring fail - safe performance, such as in the operation of nuclear facilities, aircraft navigation or communication systems, air traffic control, direct life support machines or weapons systems in which the failure of Software could lead directly to death, personal injury or severe physical or environmental damage ('High Risk Activities'). MikroElektronika and its suppliers specifically disclaim any expressed or implied warranty of fitness for High Risk Activities.

TRADEMARKS

The MikroElektronika name and logo, the MikroElektronika logo, mikroBUS™, Click Boards™ are trademarks of MikroElektronika. All other trademarks mentioned herein are property of their respective companies.

All other product and corporate names appearing in this manual may or may not be registered trademarks or copyrights of their respective companies, and are only used for identification or explanation and to the owners' benefit, with no intent to infringe.



If you want to learn more about our products, please visit our web site at www.mikroe.com

If you are experiencing some problems with any of our products or just need additional information, please place your ticket at www.mikroe.com/support

If you have any questions, comments or business proposals,
do not hesitate to contact us at office@mikroe.com

Click USB Adapter Manual
ver. 1.02



0 100000 023891