



Atop Technologies, Inc.

Industrial Managed Gigabit Ethernet Switches

EHG7504/EHG7508 Series
EHG7604/EHG7608 Series

Hardware Installation Guide

Version 1.2
Updated in November, 2016



Tel: 886-3-5508137
Fax: 886-3-5508131
www.atop.com.tw

P/N:89900488G

Package Check List

Inside the package you will find the following items:

- Industrial Managed Gigabit Ethernet Switch x 1
- 4-Pin 5.08mm Lockable Terminal Block (Already mounted to the device) x 1
- 5-Pin 5.08mm Lockable Terminal Block (Already mounted to the device) x 1
- DIN-Rail Kit (Already mounted to the device) x 1
- Protective caps for all SFP and PoE ports (Depend on purchased model)
- Installation Guide with Warranty Card x 1

- Never install or work on electrical or cabling during periods of lightning activity. Never connect or disconnect power when hazardous gases are present.
- Warning: Hot Surface Do Not Touch. RESTRICTED ACCESS AREA: The equipment should only be installed in a Restricted Access Area.
- Caution: CLASS 1 LASER PRODUCT. Do not stare into the laser!
- This equipment should be installed indoor and not connect directly with equipment installed outdoor.

Product Layout

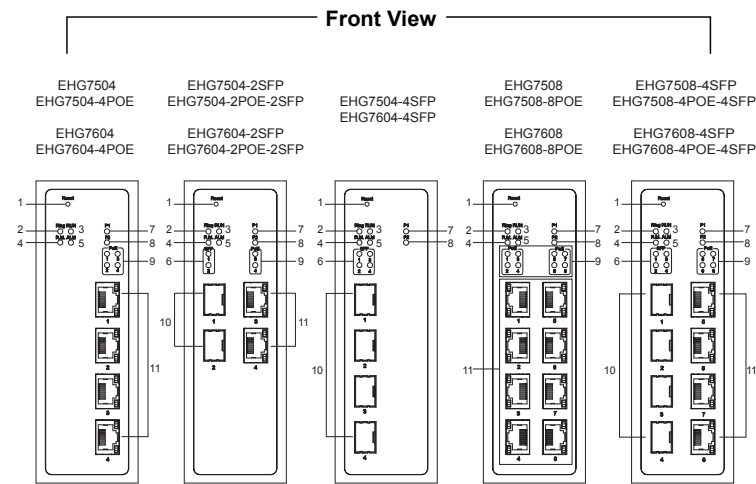

- | | |
|--------------------|--|
| 1. Reset button | 7. PWR1 LED |
| 2. Ring LED | 8. PWR2 LED |
| 3. RUN LED | 9. PoE LEDs |
| 4. Ring Master LED | 10. 1000 BASE-X SFP Slots |
| 5. Alarm LED | 11. 10/100/1000 BASE-T(X) RJ-45 Ports and/or 10/100/1000 BASE-T(X) PoE RJ-45 Ports |
| 6. SFP Ports LEDs | |

Top View

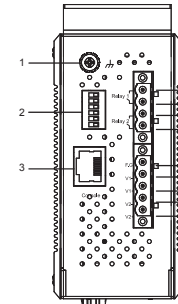

1. Grounding Screw
2. DIP Switches
3. RS-232 Console
4. Relay Output 1 with current carrying capacity of 1A@24 VDC (Normal Open)
5. Relay Output 2 with current carrying capacity of 1A@24 VDC (Normal Open)
6. Frame Ground
7. Terminal for Power 1
8. Terminal for Power 2

Installation Overview

The device's appearance is as in the figure below.

1. If you have purchased the wall mount kit, proceed to place the screws on the back of the device as show in (Fig. 1).
2. Although internal grounding has been done inside, in order to ensure overall maximum performance and protect your device, it is still strongly advised to ground the device properly; hazardous ESD can come into contact and damage your equipment. On the power terminal block, there is a terminal for Frame Ground, you can choose whether to connect it to the grounding or you may opt to connect to the grounding screw next to the terminal block (the one chosen should be connected at all times) (Fig. 2)

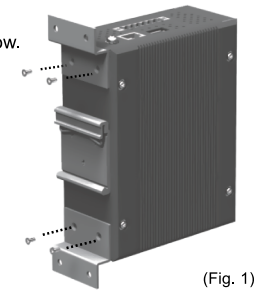

(Fig. 1)

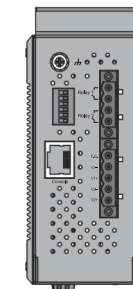

(Fig. 2)

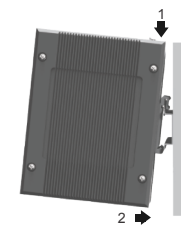

(Fig. 3)

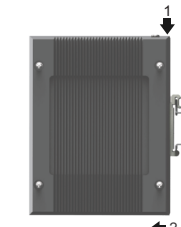

(Fig. 4)

3. You can then choose whether to plug in the other peripheral ports at this point or do it later depending on the actual location of the device or level of comfort for performing such operation.
Remember to plug in the protective caps for the unused SFP and PoE ports.
4. Once the plate has been firmly put in place, proceed to mount the whole device as shown in (Fig. 3). Proceed to (Fig. 4) if you want to remove the device from DIN-Rail.
5. Next we can then proceed to connect the device to the LAN (switch or PC, depending on the case), take care on using the RJ-45 connector; after this we can then proceed to the device's settings

- The opening to the sides are for the device's heat dissipation please never obstruct or cover them with any objects or try to insert them through it.
- This switch's factory IP by default is 10.0.50.1 you can access the device by its Web UI once it is connected to a physical network (or using Management Utility, for more information on Management Utility, please refer to its manual). Please be aware that the PC needed for this procedure needs to be in the same subnet, or you may refer yourself to the device User's Manual.

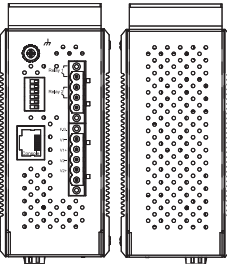

LED Indicators

Name	Color	Status	Message
P1	Green	On	Power is being supplied through this power input
		Off	Power is not supplied through this power input
ALM	Red	On	Alarm is triggered by user defined events
		Off	Alarm is not triggered by user defined events
RUN	Green	Blinking	AP firmware is running normally
		On/Off	System is not ready or halt
Ring	Green	On	All the Rings are running normally
		Blinking	Ring is in protection state
		Off	Ring is disabled
R.M.	Green	On	The device is a Master of the Ring
		Off	The device is a Slave of the Ring
SFP	Green	On	Port is linked
		Blinking	Data is transmitting on this port
		Off	No data is transmitting on this port
PoE	Amber	On	Power is being supplied to a Powered Device (PD)
		Off	Power is not supplied to a PD
LAN	Amber	On	Ethernet is connected at 1000Mbps
		Blinking	Ethernet is connected at 100Mbps
		Off	Ethernet is connected at 10Mbps
	Green	On	Ethernet is connected
		Blinking	Data is transmitting on this port
	Green	Off	Ethernet is disconnected

Power Requirements

Each device has two power requirements. For Non-PoE models, 9-57VDC can be supplied to PWR1 and/or PWR2. For PoE models, 45-57VDC should be supplied under 802.3af mode and 51-57VDC should be supplied under 802.3at mode. The maximum system power consumption is 10W under DC input. Each PoE port will consume up to 15.4W (802.3af) or 30W (802.3at). Please add up the numbers and choose a power supply wisely.

Pin Assignments and Connections

10/100/1000BASE-T(X) Ethernet, PoE and RS-232 Console Pinouts

RJ-45								
10/100BASE-T(X)								
Pin	1	2	3	4	5	6	7	8
Signal	Tx+	Tx-	Rx+			Rx-		
1000BASE-T								
Pin	1	2	3	4	5	6	7	8
Signal	BI_DA+	BI_DA-	BI_DB+	BI_DC+	BI_DC-	BI_DB-	BI_DD+	BI_DD-
PoE								
Pin	1	2	3	4	5	6	7	8
DC	V+	V+	V-			V-		
RS-232 Console								
Pin	1	2	3	4	5	6	7	8
Signal			Tx	GND	GND	Rx		

1000BASE-X Fiber Optics SFP Slot

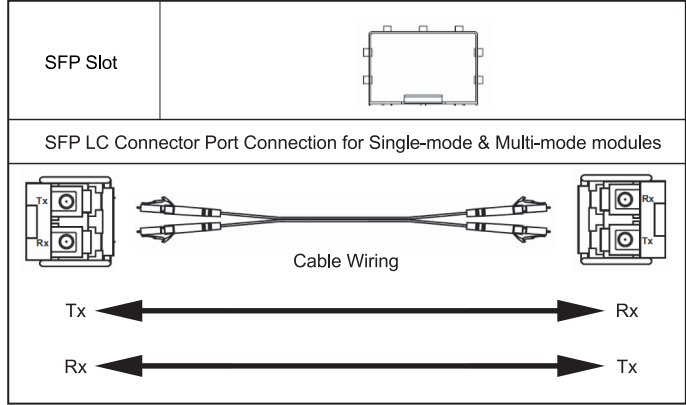

Caution
The SFP slot should be used in conjunction with a MSA compliant optical transceiver.

DIP Switch

	DIP Switch			Function
1	ON			Ring active
	OFF			Ring inactive
2	ON			Master
	OFF			Slave
3	ON	4	OFF	Compatible Ring
	OFF		ON	iA-Ring
	OFF		OFF	ERPS Ring
5	ON			Apply Profinet settings
	OFF			Apply standard switch settings
6	Reserve for future use			

*Settings are applied when the device is restored to default.

Field Maintenance and Service

If the device requires servicing of any kind, you may need to disconnect and remove it from its mounting. The initial installation should be done in a way that makes this as convenient as possible.

- Voltage/Power lines should be properly insulated as well as other cables. Be careful when handling the so as to not trip over
- Do not under any circumstance insert foreign objects of any kind into the heat dissipation holes located in the different faces of the device. This may not only harm the internal layout but might cause harm to you as well.
- Do not under any circumstance open the device for any reason. Please contact your dealer for any repair needed or follow the instructions on section of your User's Manual.

Mechanical Dimensions (Unit=mm)

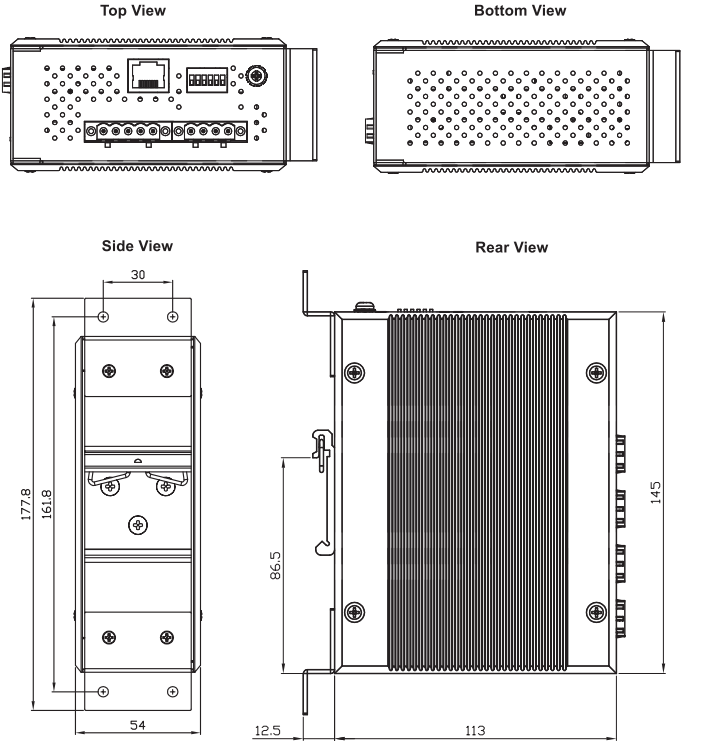
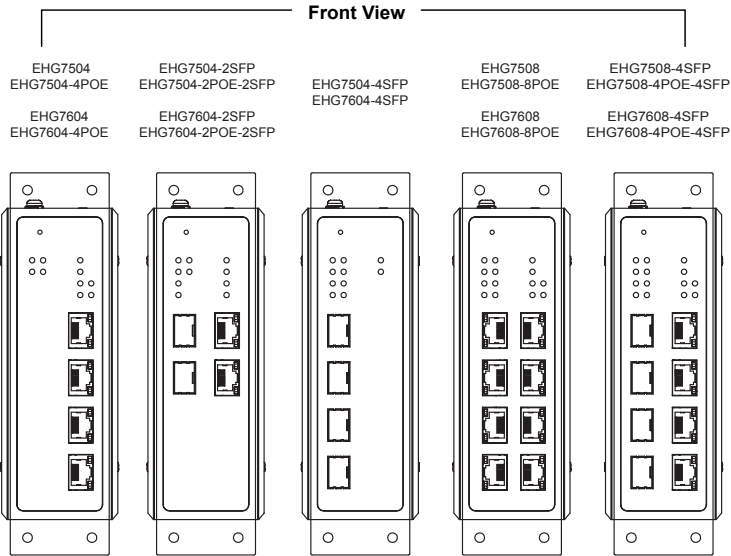

※ The wall mount kit illustrated in this document is for reference only and is not included in the package.

Warranty Policy

Warranty Conditions

Products supplied by Atop Technologies are covered in this warranty for sub-standard performance or defective workmanship. The warranty is not, however, extended to goods damaged in the following circumstances:

- Excessive forces or impacts
- War or an Act of God: wind storm, fire, flood, electric shock, earthquake
- Use of unqualified power supply, connectors, or unauthorized parts/kits
- Replacement with unauthorized parts

RMA and Shipping Costs Reimbursement

Customers shall always obtain an authorized "RMA" number from Atop before shipping the goods to be repaired to Atop. When in normal use, a sold product shall be replaced with a new one within 3 months after purchase. The shipping cost from the customer to Atop will be reimbursed by Atop.

After 3 months and still within the warranty period, it is up to Atop whether to replace the unit with a new one; normally, as long as a product is under warranty, all parts and labor are free of charge to the customers.

After the warranty period, the customer shall cover the cost for parts and labor. Three months after purchase, the shipping cost from the customer to Atop will not be reimbursed, but the shipping cost from Atop to the customer will be paid by Atop.

Limited Liability

Atop shall not be held responsible for any consequential losses from using Atop's product.

Warranty Period

Product Categories	Warranty	Product Categories	Warranty
Ethernet Switches	5 Years	DIN-Rail Power Supplies	3 Years
Wireless		Power Adaptors	1 Year
Serial Device Servers		Antennas	
Modbus Gateways		Other Accessories	
Media Converters			
Embedded Device Servers			

The warranty certification will not be effective until an authorized stamp issued by Atop's overseas agents.

Purchase Date: / / (yyyy/mm/dd)

Serial Number



Atop Customer Services and Supports

- Please contact your local dealers or Atop Technical Support Center at the following numbers.
+ 886-3-550-8137 (Atop Taiwan)
+ 86-21-6495-6232 (Atop China)
- Please report the defected problems via Atop's Web site or E-mail account
Web Site : www.atop.com.tw, e-mail : service@atop.com.tw
Web Site : www.atop.com.cn, e-mail : service@atop.com.cn

— Any changes to this material will be announced on Atop website. —