



KEELOQ[®] 3 Development Kit User's Guide

Note the following details of the code protection feature on Microchip devices:

- Microchip products meet the specification contained in their particular Microchip Data Sheet.
- Microchip believes that its family of products is one of the most secure families of its kind on the market today, when used in the intended manner and under normal conditions.
- There are dishonest and possibly illegal methods used to breach the code protection feature. All of these methods, to our knowledge, require using the Microchip products in a manner outside the operating specifications contained in Microchip's Data Sheets. Most likely, the person doing so is engaged in theft of intellectual property.
- Microchip is willing to work with the customer who is concerned about the integrity of their code.
- Neither Microchip nor any other semiconductor manufacturer can guarantee the security of their code. Code protection does not mean that we are guaranteeing the product as "unbreakable."

Code protection is constantly evolving. We at Microchip are committed to continuously improving the code protection features of our products. Attempts to break Microchip's code protection feature may be a violation of the Digital Millennium Copyright Act. If such acts allow unauthorized access to your software or other copyrighted work, you may have a right to sue for relief under that Act.

Information contained in this publication regarding device applications and the like is provided only for your convenience and may be superseded by updates. It is your responsibility to ensure that your application meets with your specifications. MICROCHIP MAKES NO REPRESENTATIONS OR WARRANTIES OF ANY KIND WHETHER EXPRESS OR IMPLIED, WRITTEN OR ORAL, STATUTORY OR OTHERWISE, RELATED TO THE INFORMATION, INCLUDING BUT NOT LIMITED TO ITS CONDITION, QUALITY, PERFORMANCE, MERCHANTABILITY OR FITNESS FOR PURPOSE. Microchip disclaims all liability arising from this information and its use. Use of Microchip devices in life support and/or safety applications is entirely at the buyer's risk, and the buyer agrees to defend, indemnify and hold harmless Microchip from any and all damages, claims, suits, or expenses resulting from such use. No licenses are conveyed, implicitly or otherwise, under any Microchip intellectual property rights.

Trademarks

The Microchip name and logo, the Microchip logo, Accuron, dsPIC, KEELOQ, KEELOQ logo, MPLAB, PIC, PICmicro, PICSTART, rfPIC, SmartShunt and UNI/O are registered trademarks of Microchip Technology Incorporated in the U.S.A. and other countries.

FilterLab, Linear Active Thermistor, MXDEV, MXLAB, SEEVAL, SmartSensor and The Embedded Control Solutions Company are registered trademarks of Microchip Technology Incorporated in the U.S.A.

Analog-for-the-Digital Age, Application Maestro, CodeGuard, dsPICDEM, dsPICDEM.net, dsPICworks, dsSPEAK, ECAN, ECONOMONITOR, FanSense, In-Circuit Serial Programming, ICSP, ICEPIC, Mindi, MiWi, MPASM, MPLAB Certified logo, MPLIB, MPLINK, mTouch, nanoWatt XLP, PICKit, PICDEM, PICDEM.net, PICTail, PIC³² logo, PowerCal, PowerInfo, PowerMate, PowerTool, REAL ICE, rfLAB, Select Mode, Total Endurance, TSHARC, WiperLock and ZENA are trademarks of Microchip Technology Incorporated in the U.S.A. and other countries.

SQTP is a service mark of Microchip Technology Incorporated in the U.S.A.

All other trademarks mentioned herein are property of their respective companies.

© 2009, Microchip Technology Incorporated, Printed in the U.S.A., All Rights Reserved.

 Printed on recycled paper.

QUALITY MANAGEMENT SYSTEM
CERTIFIED BY DNV
== ISO/TS 16949:2002 ==

Microchip received ISO/TS-16949:2002 certification for its worldwide headquarters, design and wafer fabrication facilities in Chandler and Tempe, Arizona; Gresham, Oregon and design centers in California and India. The Company's quality system processes and procedures are for its PIC[®] MCUs and dsPIC[®] DSCs, KEELOQ[®] code hopping devices, Serial EEPROMs, microperipherals, nonvolatile memory and analog products. In addition, Microchip's quality system for the design and manufacture of development systems is ISO 9001:2000 certified.

Table of Contents

Chapter 1. KEELOQ[®] 3 Development Kit Overview

1.1 Introduction	7
1.2 Highlights	7
1.3 KEELOQ 3 Development Kit Contents	7
1.4 KEELOQ Development Systems	8
1.5 KEELOQ 3 Development Kit Hardware	8
1.5.1 Controller Board	8
1.5.2 Receiver Board	9
1.5.3 Transmitter Boards	10
1.6 KEELOQ 3 Development Kit Software	11
1.6.1 The MPLAB [®] Plug-In	11
1.6.2 Controller I ² C [™] Graphical User Interface	11

Chapter 2. Getting Started

2.1 Introduction	13
2.2 Highlights	13
2.3 Setting Up the KEELOQ 3 Development Kit Hardware	13
2.3.1 Using the Transmitter Boards	14
2.3.2 How the Controller Board Learns a Transmitter	15
2.3.3 How the Controller Board Erases Stored Transmitter Information	15
2.4 Installing the KEELOQ 3 Development Kit Software	15
2.4.1 Installing the MPLAB Plug-In	15
2.4.2 Installing the I ² C GUI Sample Program	16
2.5 Starting the MPLAB Plug-In	16
2.6 Starting the I ² C GUI Demonstration Program	16
2.7 Demo I ² C [™] Source Code and Firmware	16

Chapter 3. Using the KEELOQ[®] 3 Development Kit MPLAB[®] Plug-In

3.1 Introduction	17
3.2 Highlights	17
3.3 Installing the KEELOQ 3 Development Kit Plug-In	17
3.4 Starting the Program	17
3.5 Selecting a Device	17
3.6 Programming the HCS362 Transmitter.	18
3.6.1 Programming the Part	20
3.7 Programming the PIC16F636 Transmitter	20
3.8 Memory Map for XTEA/AES	24

KEELOQ[®] 3 Development Kit User's Guide

Chapter 4. Using the I²C™ GUI Interface Demo Tool

4.1 Introduction	25
4.2 Highlights	25
4.3 Overview: Installing the I ² C Graphical User Interface	25
4.4 Interface Window	26
4.5 Resetting the PICkit™ Serial	27
4.6 Communications Test	27
4.7 Erasing and Learning Transmitters	27
4.8 Receiving Data	27
4.9 LED Commands	28
4.10 I ² C™ Communications – Summary of Commands	28

Chapter 5. KEELOQ[®] Development Kit Controller

5.1 Introduction	29
5.2 Highlights	29
5.3 PICkit™ Serial Pin Assignments	29
5.4 PICkit™ 2 Pin assignments	30
5.5 Learning a Transmitter to the Controller	30
5.6 Receiver Board Selector Pin	31
5.7 PICtail™ Connector	31
5.8 LCD Display	31
5.9 Main Processor	31
5.10 Power Supply and Prototyping Area	31

Chapter 6. KEELOQ[®] Development Kit Controller Firmware

6.1 Introduction	33
6.2 Highlights	33
6.3 KEELOQ Data Packet Receiving	33
6.4 KEELOQ Decryption	34
6.5 I ² C Communication	34
6.6 LCD Display	34

Chapter 7. KEELOQ[®] Development Kit PIC16F636 Transmitter

7.1 Introduction	35
7.2 Highlights	35
7.3 Main Features	35
7.4 PICkit™ 2 Pin Assignments	36
7.5 Programming the Transmitter	36
7.6 Transmitter Firmware	36

Chapter 8. Troubleshooting

8.1 Introduction	37
8.2 Frequently Asked Questions	37

Appendix A. KEELOQ[®] 3 Development Kit Schematics

Preface

NOTICE TO CUSTOMERS

All documentation becomes dated, and this manual is no exception. Microchip tools and documentation are constantly evolving to meet customer needs, so some actual dialogs and/or tool descriptions may differ from those in this document. Please refer to our web site (www.microchip.com) to obtain the latest documentation available.

Documents are identified with a “DS” number. This number is located on the bottom of each page, in front of the page number. The numbering convention for the DS number is “DSXXXXA”, where “XXXX” is the document number and “A” is the revision level of the document.

For the most up-to-date information on development tools, see the MPLAB[®] IDE on-line help. Select the Help menu, and then Topics to open a list of available on-line help files.

INTRODUCTION

This chapter contains general information that will be useful to know before using the KEELOQ[®] 3 Development Kit User's Guide. Items discussed in this chapter include:

- Document Layout
- Conventions Used in this Guide
- Warranty Registration
- Recommended Reading
- The Microchip Web Site
- Development Systems Customer Change Notification Service
- Customer Support
- Document Revision History

DOCUMENT LAYOUT

This document describes how to use the KEELOQ[®] 3 Development Kit User's Guide as a development tool to emulate and debug firmware on a target board. The manual layout is as follows:

- **Chapter 1. “KEELOQ[®] 3 Development Kit Overview”**
- **Chapter 2. “Getting Started”**
- **Chapter 3. “Using the KEELOQ[®] 3 Development Kit MPLAB[®] Plug-In”**
- **Chapter 4. “Using the I²C™ GUI Interface Demo Tool”**
- **Chapter 5. “KEELOQ[®] Development Kit Controller”**
- **Chapter 6. “KEELOQ[®] Development Kit Controller Firmware”**
- **Chapter 7. “KEELOQ[®] Development Kit PIC16F636 Transmitter”**
- **Chapter 8. “Troubleshooting”**
- **Appendix A. “KEELOQ[®] 3 Development Kit Schematics”**

KEELOQ[®] 3 Development Kit User's Guide

CONVENTIONS USED IN THIS GUIDE

This manual uses the following documentation conventions:

DOCUMENTATION CONVENTIONS

Description	Represents	Examples
Arial font:		
Italic characters	Referenced books	<i>MPLAB[®] IDE User's Guide</i>
	Emphasized text	...is the <i>only</i> compiler...
Initial caps	A window	the Output window
	A dialog	the Settings dialog
	A menu selection	select Enable Programmer
Quotes	A field name in a window or dialog	"Save project before build"
Underlined, italic text with right angle bracket	A menu path	<u><i>File>Save</i></u>
Bold characters	A dialog button	Click OK
	A tab	Click the Power tab
N'Rnnnn	A number in verilog format, where N is the total number of digits, R is the radix and n is a digit.	4'b0010, 2'hF1
Text in angle brackets < >	A key on the keyboard	Press <Enter>, <F1>
Courier New font:		
Plain Courier New	Sample source code	#define START
	Filenames	autoexec.bat
	File paths	c:\mcc18\h
	Keywords	_asm, _endasm, static
	Command-line options	-Opa+, -Opa-
	Bit values	0, 1
	Constants	0xFF, 'A'
Italic Courier New	A variable argument	<i>file.o</i> , where <i>file</i> can be any valid filename
Square brackets []	Optional arguments	mcc18 [options] <i>file</i> [options]
Curly brackets and pipe character: { }	Choice of mutually exclusive arguments; an OR selection	errorlevel {0 1}
Ellipses...	Replaces repeated text	var_name [, var_name...]
	Represents code supplied by user	void main (void) { ... }

WARRANTY REGISTRATION

Please complete the enclosed Warranty Registration Card and mail it promptly. Sending in the Warranty Registration Card entitles users to receive new product updates. Interim software releases are available at the Microchip web site.

RECOMMENDED READING

This user's guide describes how to use KEELOQ[®] 3 Development Kit User's Guide. Other useful documents are listed below. The following Microchip documents are available and recommended as supplemental reference resources.

Readme for KEELOQ[®] 3 Development Kit User's Guide

For the latest information on using KEELOQ[®] 3 Development Kit User's Guide, read the "Readme for KEELOQ[®] 3 Development Kit User's Guide.txt" file (an ASCII text file) in the Readmes subdirectory of the MPLAB IDE installation directory. The Readme file contains update information and known issues that may not be included in this user's guide.

Readme Files

For the latest information on using other tools, read the tool-specific Readme files in the Readmes subdirectory of the MPLAB IDE installation directory. The Readme files contain update information and known issues that may not be included in this user's guide.

KEELOQ[®] 3 Development Kit User's Guide

THE MICROCHIP WEB SITE

Microchip provides online support via our web site at www.microchip.com. This web site is used as a means to make files and information easily available to customers. Accessible by using your favorite Internet browser, the web site contains the following information:

- **Product Support** – Data sheets and errata, application notes and sample programs, design resources, user's guides and hardware support documents, latest software releases and archived software
- **General Technical Support** – Frequently Asked Questions (FAQs), technical support requests, online discussion groups, Microchip consultant program member listing
- **Business of Microchip** – Product selector and ordering guides, latest Microchip press releases, listing of seminars and events, listings of Microchip sales offices, distributors and factory representatives

DEVELOPMENT SYSTEMS CUSTOMER CHANGE NOTIFICATION SERVICE

Microchip's customer notification service helps keep customers current on Microchip products. Subscribers will receive e-mail notification whenever there are changes, updates, revisions or errata related to a specified product family or development tool of interest.

To register, access the Microchip web site at www.microchip.com, click on Customer Change Notification and follow the registration instructions.

The Development Systems product group categories are:

- **Compilers** – The latest information on Microchip C compilers and other language tools. These include the MPLAB C18 and MPLAB C30 C compilers; MPASM[™] and MPLAB ASM30 assemblers; MPLINK[™] and MPLAB LINK30 object linkers; and MPLIB[™] and MPLAB LIB30 object librarians.
- **Emulators** – The latest information on Microchip in-circuit emulators. This includes the MPLAB ICE 2000 and MPLAB ICE 4000.
- **In-Circuit Debuggers** – The latest information on the Microchip in-circuit debugger, MPLAB ICD 2.
- **MPLAB[®] IDE** – The latest information on Microchip MPLAB IDE, the Windows[®] Integrated Development Environment for development systems tools. This list is focused on the MPLAB IDE, MPLAB SIM simulator, MPLAB IDE Project Manager and general editing and debugging features.
- **Programmers** – The latest information on Microchip programmers. These include the MPLAB PM3 and PRO MATE[®] II device programmers and the PICSTART[®] Plus and PICkit[™] 1 development programmers.

CUSTOMER SUPPORT

Users of Microchip products can receive assistance through several channels:

- Distributor or Representative
- Local Sales Office
- Field Application Engineer (FAE)
- Technical Support

Customers should contact their distributor, representative or field application engineer (FAE) for support. Local sales offices are also available to help customers. A listing of sales offices and locations is included in the back of this document.

Technical support is available through the web site at: <http://support.microchip.com>

DOCUMENT REVISION HISTORY

Revision A (March 2009)

- Initial Release of this Document.

KEELOQ[®] 3 Development Kit User's Guide

NOTES:

Chapter 1. KEELOQ[®] 3 Development Kit Overview

1.1 INTRODUCTION

The KEELOQ[®] 3 Development Kit consists of a controller board, a radio receiver board and two handheld transmitters.

The controller board uses a modular approach so it can be used in various configurations. The board features a 14-pin PICKit™ Tail connector to accommodate a radio receiver board and a 28-pin PICKit Tail connector for expansion. The PIC16F886 microcontroller on the controller board can be programmed in circuit using the onboard PICKit 2 connector. Also, it can be connected to the PICKit Serial Analyzer for serial communication with a PC.

One *receiver board* containing the Microchip rRXD0420 ASK radio receiver chip is included in the kit.

Two *hand-held transmitters* are included with the KEELOQ 3 Development Kit. One uses a standard HCS362 hardware encoder and the other uses a PIC16F636 microcontroller.

To assist in KEELOQ encoder/decoder development and programming, an MPLAB KEELOQ plug-in is also supplied. A separate graphical user interface (GUI) is supplied to demonstrate I²C communication using the PICKit serial analyzer connection.

In addition to the traditional KEELOQ encryption/decryption routines, KEELOQ/AES and KEELOQ/XTEA encryption/decryption routines are available by ordering the CD “Advanced Security Algorithms for KEELOQ[®] Systems” (DS51813).

1.2 HIGHLIGHTS

This chapter discusses:

- KEELOQ 3 Development kit contents
- KEELOQ 3 Development kit Hardware
- KEELOQ 3 Development kit Software

1.3 KEELOQ 3 DEVELOPMENT KIT CONTENTS

The KEELOQ 3 Development Kit contains the following items:

- KEELOQ 3 controller board
- PIC16F636 KEELOQ transmitter
- HCS362 KEELOQ transmitter
- 433.92 MHz ASK receiver board
- Documentation and software CD-ROM
- Optional PICKit 2 Programmer/Debugger
- Optional USB cable
- Optional PICKit Serial Analyzer

KEELOQ[®] 3 Development Kit User's Guide

1.4 KEELOQ DEVELOPMENT SYSTEMS

The KEELOQ 3 Development Kit is a hardware platform that can be used to evaluate various KEELOQ-based encryption/decryption solutions. Once the user gets familiar with the operation of the kit, the software can be modified to suit the user's needs. The kit itself is based on a modular approach so it can be used in many configurations without being restricted to a specific application.

1.5 KEELOQ 3 DEVELOPMENT KIT HARDWARE

1.5.1 Controller Board

FIGURE 1-1: KEELOQ[®] 3 DEVELOPMENT KIT

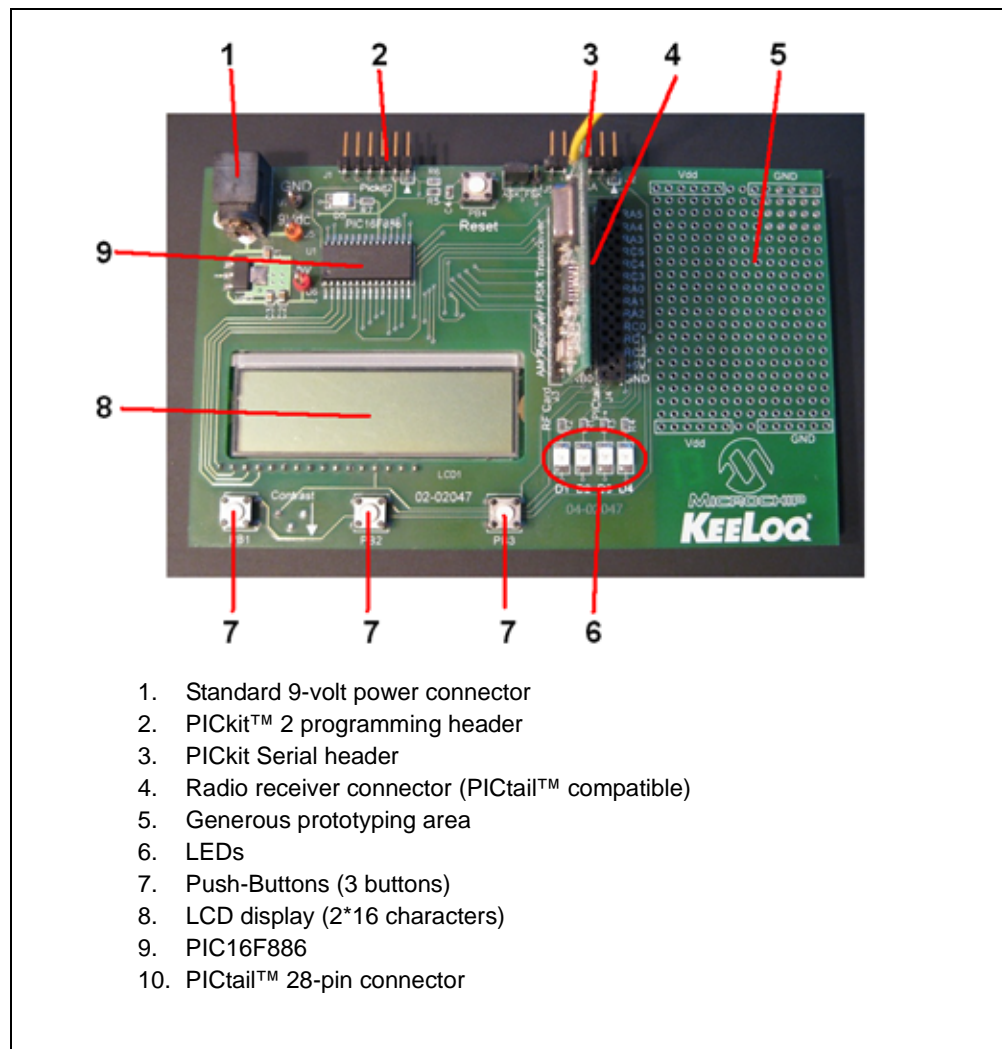

The controller board is meant to be a decoding portion of a complete security system, such as a car security system, garage door or any other application requiring data encryption.

The controller is also the radio receiver and decoder of the KEELOQ Kit. The received data is decrypted and checked against a known transmitter (if it was previously learned by the controller), then the Transmitter function is signaled to the user.

The controller features various connectivity elements. The supplied receiver card features a Microchip rRXD0420 ASK radio receiver chip used in the 433.92 MHz ISM band. Because the receiver is a separate card with a PICtail™ connector ([4] in Figure 1-1), the user can replace the receiver card with any custom radio receiver unit.

The heart of the controller board is the Microchip PIC16F886 microcontroller ([9] in Figure 1-1). The controller features a PICkit 2 compatible connector header ([2] in Figure 1-1) that allows in-circuit programming using the PICkit 2 microcontroller programmer/debugger. Any other Microchip programmer/debugger tool can be used, provided that:

- The programmer/debugger supports the PIC16F886 (please check for the latest firmware update for the programmer).
- Some in-circuit debuggers use an RJ-11 connector. You will need an RJ-11 to ICSP™ adapter (Microchip part number AC164110).

To demonstrate serial communication, the board can be connected to the Microchip PICkit Serial Analyzer module through the PICkit serial header ([3] in Figure 1-1). The controller firmware is configured to support I²C slave communication (the PICkit Serial module should be configured as the master).

Also, for user interaction with the board, the following elements are present on the board:

- a LCD display (2* 16 characters) ([8] in Figure 1-1)
- 3 push buttons ([7] in Figure 1-1)
- 4 LED's ([6] in Figure 1-1)

The control board can be powered in one of the following ways:

- Using a 9-volt adapter connected to the board's power socket ([1] in Figure 1-1)
- PICkit 2 supplied power
- PICkit Serial Analyzer supplied power

1.5.2 Receiver Board

The receiver board features the Microchip rRXD0420, low-cost, high-performance ASK receiver IC. The module is suitable for:

- Wireless remote command and control
- Remote Keyless Entry (RKE)
- Security Systems
- Low-power telemetry applications

The module characteristics are:

- Single channel, fixed frequency of 433.92 MHz
- ASK modulation
- Baud rate: 4800bps

For more information on the rRXD0420 receiver module, please refer to the technical brief TB070.

FIGURE 1-2: RFRXD0420 RECEIVER BOARD



1.5.3 Transmitter Boards

FIGURE 1-3: TRANSMITTER BOARD

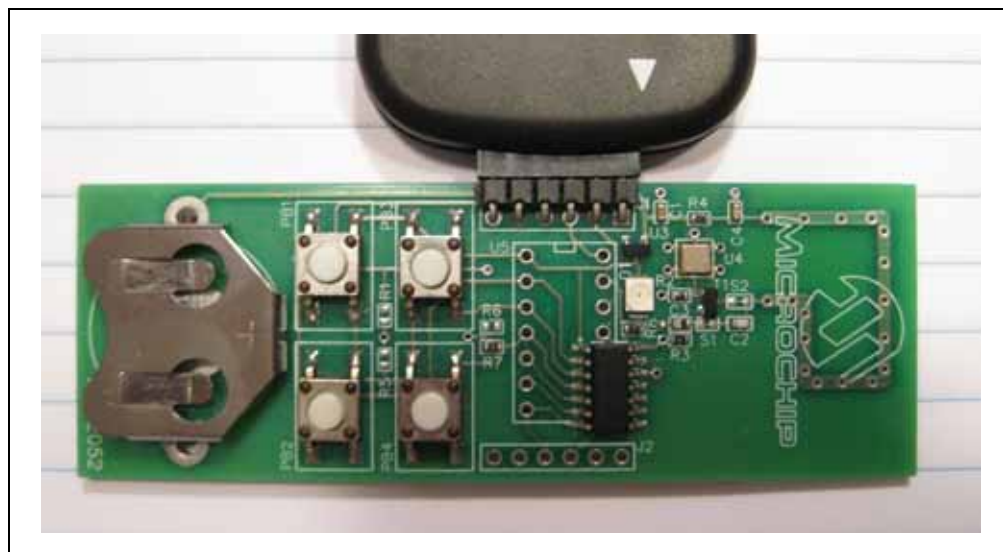

The kit contains two hand-held transmitter boards:

- HCS362 KEELOQ hardware encoder
- PIC16F636 microcontroller software encoder

These transmitters allow the user to explore a wider range of hardware configurations. Additionally, both transmitters can be modified to add DIP sockets, enabling the user to change the encoder device easily.

The RF transmitters use a simple Colpitts oscillator driven by a SAW (Surface Acoustic Wave) resonator. Both transmitters are powered by a CR2032 or equivalent 3V battery (not included in the kit).

1.6 KEELOQ 3 DEVELOPMENT KIT SOFTWARE

1.6.1 The MPLAB[®] Plug-In

The KEELOQ 3 Development Kit MPLAB plug-in is a tool that integrates into the MPLAB Integrated Development Environment. It helps with setting and programming the transmitter encoders. The MPLAB plug-in supports KEELOQ/XTEA/AES key generation. To enable the XTEA/AES options please order the CD *“Advanced Security Algorithms for KEELOQ[®] Systems”* (DS51813).

More detailed information can be found in **Chapter 3. “Using the KEELOQ 3 Development Kit MPLAB Plug-In”**.

1.6.2 Controller I²C[™] Graphical User Interface

The controller firmware supports a set of I²C commands. These commands are used to control and interact with the Controller Board Decoding functions.

The I²C GUI uses the PICkit Serial Analyzer connected to the controller to communicate and display the results on the PC. More details can be found in **Chapter 4. “Using the I²C[™] GUI Interface Demo Tool”**.

KEELOQ[®] 3 Development Kit User's Guide

NOTES:

Chapter 2. Getting Started

2.1 INTRODUCTION

This chapter will get you started using the KEELOQ[®] 3 Development Kit and the attached software.

2.2 HIGHLIGHTS

This chapter discusses:

- Setting up the KEELOQ 3 Development Kit hardware
- Installing the KEELOQ 3 Development Kit software
- Starting the KEELOQ 3 Development Kit software
- Basic I²C communication
- Source code

2.3 SETTING UP THE KEELOQ 3 DEVELOPMENT KIT HARDWARE

Plug the radio board into the PICtail 14 pin connector as shown in Figure 2-1 below:

FIGURE 2-1: PICtail™ 14-PIN ASK CONNECTION

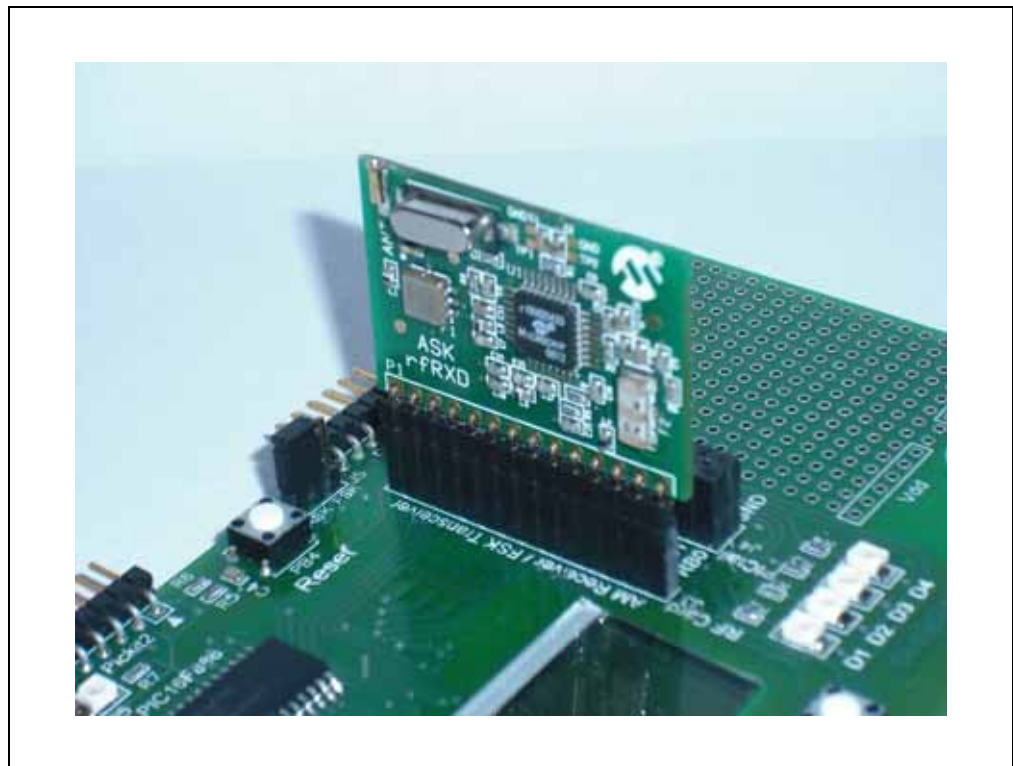

Connect the controller to a 9V DC power supply.

KEELOQ[®] 3 Development Kit User's Guide

Once powered up, the controller LED-D1 will flash five times and the welcome screen will appear on the LCD screen:

“KEELOQ 3 Development Kit”

FIGURE 2-2: LCD SCREEN – WELCOME MESSAGE



2.3.1 Using the Transmitter Boards

Install a 3V CR2032 or equivalent battery on the PIC16F636 transmitter board. Press any button on the transmitter board. LED-D4 will flash and the serial number and the decoded transmitted information will appear on the LCD display.

FIGURE 2-3: LCD SCREEN WITH DECODED INFORMATION



2.3.2 How the Controller Board Learns a Transmitter

- Press button **PB3** on the controller board. LED-D4 will remain on indicating the controller has entered Learn mode.
- Press a button on the transmitter once, the LED will blink indicating that the controller is waiting for a second press.
- Press the transmitter button a second time. LED-D4 will flash rapidly followed by LED-D3.
- Now, whenever the transmitter button is pressed, LED-D4 will flash, followed by LED-D3 indicating that the transmitter is a valid learned transmitter.

2.3.3 How the Controller Board Erases Stored Transmitter Information

- Press button **PB3** on the controller board. LED-D4 will remain on.
- Keep button pressed for about 10 seconds. LED-D4 will turn off.
- Release **PB3**, all stored transmitter information is now erased. When a transmitter button is pressed, LED-D4 will now flash rapidly.

2.4 INSTALLING THE KEELOQ 3 DEVELOPMENT KIT SOFTWARE

2.4.1 Installing the MPLAB Plug-In

From the CD, run *MPLAB PlugIn > MPLAB PlugInSetup.exe*.

The installer software installs everything automatically. Once the installer software begins you must accept the Microchip License Agreement in order to proceed with the installation process.

More details can be found in **Chapter 3. "Using the KEELOQ 3 Development Kit MPLAB Plug-In"**.

2.4.2 Installing the I²C GUI Sample Program

From the CD, run *I2C GUI > I2C GUI Setup.exe*.

The installer software installs everything automatically. There is no KEELOQ related license agreement for the I²C Graphical User Interface. However, the software is covered by Microchip's general license terms.

More details about the installation process can be found in **Section 4.3 "Overview: Installing the I2C Graphical User Interface"**.

2.5 STARTING THE MPLAB PLUG-IN

To start the plug-in:

Launch MPLAB[®] IDE (navigate to *Start > All Programs > Microchip > MPLAB IDE v8.xx > MPLAB IDE*).

In MPLAB IDE, under the *Tools* menu, click on **KEELOQ 3 Development Kit**.

2.6 STARTING THE I²C GUI DEMONSTRATION PROGRAM

You can start the KEELOQ 3 Development Kit I²C Graphical User Interface by navigating to *Start > All Programs > Microchip > KEELOQ 3 Development Kit > click on I²C GUI*. For detailed information, see **Chapter 4. "Using the I2C[™] GUI Interface Demo Tool"**.

2.7 DEMO I²C[™] SOURCE CODE AND FIRMWARE

The source code is installed automatically by the I²C Graphical User Interface installation program.

To start the KEELOQ 3 Development Kit I²C Graphical User Interface, navigate to *Start > All Programs > Microchip > KEELOQ 3 Development Kit > click on I²C GUI VB workspace*.

Chapter 3. Using the KEELOQ 3 Development Kit MPLAB Plug-In

3.1 INTRODUCTION

The KEELOQ[®] 3 Development Kit MPLAB[®] Plug-in is a tool that integrates into the MPLAB Integrated Development Environment.

The KEELOQ MPLAB Plug-in automatically calculates the necessary codes needed for a KEELOQ encoder. These include the encryption key, configuration parameters, seed, and serial number.

Also, the KEELOQ MPLAB Plug-in features some debugging tools such as a code calculator that allows the user to KEELOQ encrypt and/or decrypt a code for debugging purposes.

It also allows encoder programming directly from the MPLAB IDE.

3.2 HIGHLIGHTS

This chapter discusses:

- Installing the KEELOQ 3 Development Kit Plug-in
- Starting the plug-in
- Selecting a device
- Programming the HCS362 based transmitter
- Programming a PIC16F636 based transmitter
- KEELOQ tool

3.3 INSTALLING THE KEELOQ 3 DEVELOPMENT KIT PLUG-IN

Insert the KEELOQ 3 Development Kit CD-ROM into the CD-ROM drive. Browse the CD-ROM directory and find the *Setup.exe* file located in the MPLAB KEELOQ Plug-in directory.

Follow the directions on the screen to install the KEELOQ 3 Development Kit Plug-in. MPLAB-IDE must be already installed.

3.4 STARTING THE PROGRAM

You can start the plug-in by starting the MPLAB IDE (navigate to Start > All Programs > Microchip > MPLAB IDE v8.xx > MPLAB IDE)

In MPLAB IDE, under the *Tools* menu, click on **KEELOQ 3 Development Kit**.

The plug-in can be used with or without having a currently loaded project (workspace).

3.5 SELECTING A DEVICE

In the MPLAB KEELOQ plug-in there is a selection tree in the left side.

Click on an item in the left side tree. The right side of the Main window changes according to the current selected item.

3.6 PROGRAMMING THE HCS362 TRANSMITTER.

The MPLAB KEELOQ Plug-in supports direct programming of the HCS362 transmitter using one of the following programmers:

- PICkit 2 microcontroller programmer
- PM3 universal programmer.

To select a programmer:

- Under the KEELOQ menu, go to *Programmer* menu
- Select one of the supported programmers

Note: The programming section of the MPLAB KEELOQ plug-in is independent of the MPLAB programming section. When programming a hardware KEELOQ encoder (such as the HCS series) there is no need to change the current selected device in the main MPLAB window. However, there is a limitation that one programmer cannot be selected as active programmer for both the KEELOQ plug-in and the MPLAB current programmer. If using the same programmer, you can deselect it in the MPLAB main window and use it with the KEELOQ plug-in. Different programmers can be used at the same time.

To enter the manufacturer code:

- In the two lower side boxes, enter the manufacturer codes needed to calculate both encryption keys

Please note that once the manufacturer code was entered, it is internally stored but it will not be displayed – the manufacturer code edit box will show “xxxxxxxxxxxxxxxx”.

Programming all the encoder options is done by means of the selection boxes and check boxes (as shown in Figure 3-1).

The HCS362 transmitter only supports traditional KEELOQ encryption.

Using the KEELOQ 3 Development Kit MPLAB Plug-In

FIGURE 3-1: HCS362 OPTIONS WINDOW

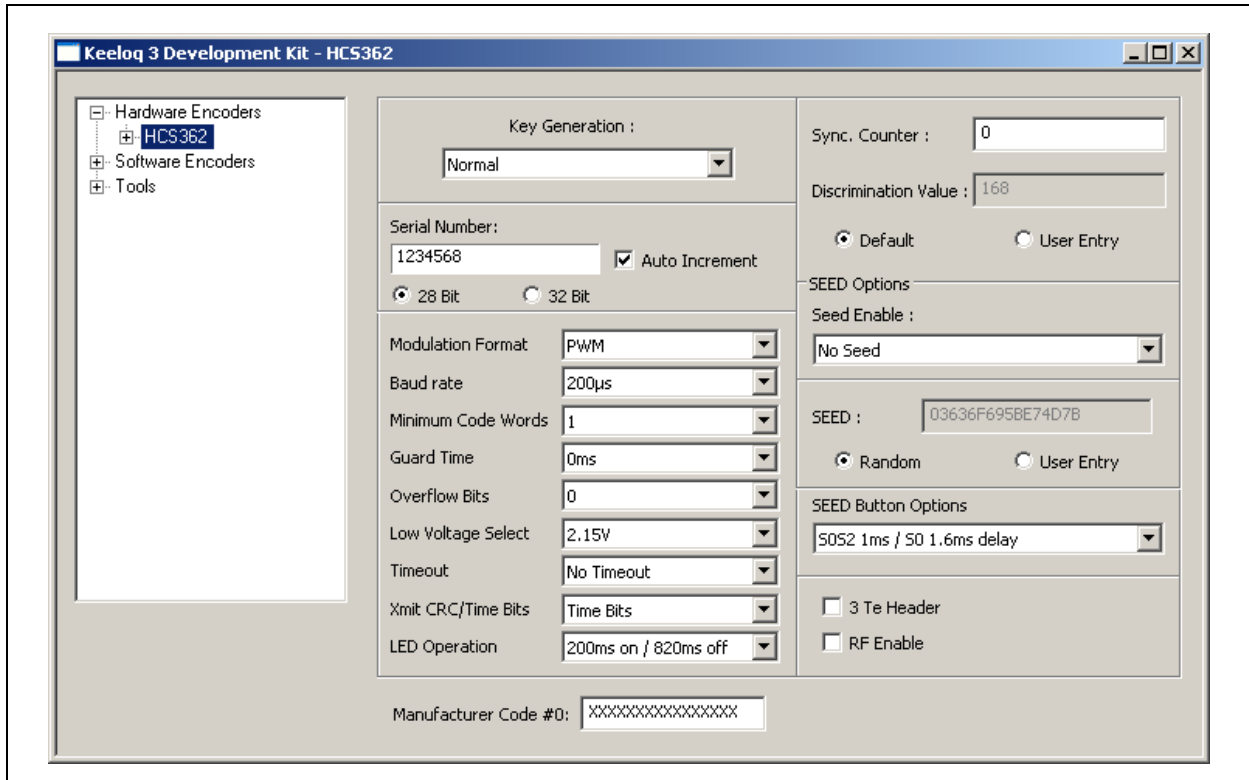

All the encoder configuration options are explained in the following table:

TABLE 3-1: ENCODER CONFIGURATION OPTIONS

Configuration Option	Description
Key Generation	Select the Key generation algorithm.
User Serial Number	Enter a 28/32-bit hex value. If the Extended Serial Number option is not selected, only the 28 LSbs will be transmitted.
Auto Increment	This will cause the serial number field to increment if an encoder is programmed successfully.
28-bit or 32-bit	If 32-bit is selected, the full 32-bit serial number is transmitted. If 28-bit is selected, the top serial number nibble is replaced with the function code.
Modulation Format	There are two modulation formats: PWM and Manchester.
Baud Rate	TE value used during transmissions. Select Baud Rate: 100 µs, 200 µs, 400 µs or 800 µs.
Minimum Code Words	Used to select the minimum number of code words transmitted when the device is activated.
Guard Time	The longest guard time or time between transmissions can be used to lower the average power transmitted during a period of time to help meet regulatory requirements.
Overflow Bits	Select the overflow cycles for the synchronous counters.
Low Voltage Select	Selects the voltage at which the VLOW flag (bit) is set in a transmission.
Time-out	If enabled, the device will shut off after transmitting continuously for a predetermined time. This prevents a complete battery discharge if an input transmitter button is stuck in the ON position.
Xmit CRC/Time Bits	You can select the desired functionality of these two Status bits. Selecting CRC will enable a two-bit Cyclic Redundancy Check code used by the decoder to verify the integrity of a code word. Selecting Time bits will send different bit patterns at different points in time when pressing and holding a button. This permits multiple functions obtained from the same function code.

KEELOQ® 3 Development Kit User's Guide

TABLE 3-1: ENCODER CONFIGURATION OPTIONS

LED Operation	Two different LED flashing rates are available which correspond to different low battery indication modes.
Sync. Counter	Enter a 16-bit hex value (0 through FFFF). This is the initial value of the synchronization counter.
Discrimination Value	You can opt for the default setting equal to the 10 LSBs of the serial number or enter an arbitrary 10-bit value (0 through 3FF).
SEED Enable	Select between four modes of operation: No Seed – disables the Seed transmission feature Limited Seed – disables Seed transmission when the synchronization counter reaches 80 hex (128) Permanent and Delayed Seed – Seed transmissions are permanently enabled and delayed Permanent Seed only – disables the Delayed Seed Transmission function codes
SEED	The Seed is a 60-bit value that can be either random (recommended for Secure Learn methods) or an arbitrary 60-bit value. It will be transmitted in place of the hopping code and fixed code portions of the code word when the predetermined Seed function code (button) is activated.
SEED Button Options	This field determines what function code will produce an immediate or delayed Seed transmission.
3 TE Header	This option allows you to shorten the synchronization header to 3xTE. Otherwise, the default value is 10xTE
RF Enable	If enabled, this option produces a high output on the S3 pin before data is transmitted through the DATA pin. The S3 pin will still be available as a button input, but its de-bouncing and repeat timing functionality will be affected.

3.6.1 Programming the Part

Click on the **Program** button in the toolbar:



Programming progress is displayed in the MPLAB Output window.

After a successful programming, if the option is enabled, the serial code is incremented and a new programming sequence can start.

3.7 PROGRAMMING THE PIC16F636 TRANSMITTER

The PIC16F636 transmitter is a microcontroller-based solution, allowing the firmware to be adapted for a particular need. The PIC16F636 KEELOQ Software encoder KEELOQ/XTEA, KEELOQ/AES source codes are provided by Microchip under the KEELOQ encoder license agreement.

All the encoder configuration data, encryption keys, seeds, and serial numbers are stored into the EEPROM of the PIC16F636.

The MPLAB KEELOQ plug-in cannot directly program the microcontroller in the same way as programming a hardware encoder. Instead, the KEELOQ software encoder source code must be loaded into MPLAB. The MPLAB KEELOQ plug-in can export the memory map for the current encoder options to the EEPROM memory. Programming is done in the usual way, as when programming a microcontroller.

Using the KEELOQ 3 Development Kit MPLAB Plug-In

TABLE 3-2: PIC16F636 TRANSMITTER CONFIGURATION TRADITIONAL KEELOQ OPTIONS

Configuration Option	Description
Encryption Key	Selects key generation algorithm.
Serial Number	Enter a 28-bit or a 32-bit hex value depending on the 28 or 32-bit selection below the serial number box.
Auto Increment	This will cause the serial number field to increment if an encoder is programmed successfully.
28-bit or 32-bit radio buttons	If 32-bit is selected, 32-bit serial numbers can be used. If 28-bit is selected, only 28-bit serial numbers can be used. Also, if the current serial number has more than 28 bits, it is automatically adjusted to 28 bits.
Modulation Format	There are four modulation formats: PWM, Manchester, VPWM, and PPM.
Baud Rate	TE value used during transmissions. There are four baud rates: 100 μ s, 200 μ s, 400 μ s, and 800 μ s.
Header Length	Select the header time frame as either 4xTE or 10xTE.
Guard Time	Extending the guard time can be used to lower the average power transmitted during a period of time; to help meet regulatory requirements.
Low Voltage LED Blink	If set to Once, the transmitter's LED blinks only once if a low battery condition is detected.
LED On Time	Allows selection of the LED blink timing.
Overflow Bits	Select the overflow cycles for the synchronous counters.
SEED	The Seed is a 60-bit value that can be either random (recommended for Secure Learn methods) or an arbitrary 60-bit value. It will be transmitted in place of the hopping code and fixed code portions of the code word when the predetermined Seed function code (button) is activated.
SEED Button	This field determines what function code will produce an immediate or delayed Seed transmission.
SEED Trigger	This field determines what function code will produce an immediate or delayed Seed transmission.
Time before SEED	Determines if and when a delayed Seed transmission will be activated by the Seed Button function code.
Production SEED	If enabled, the Seed mode is set to Production mode. If disabled, it is set to User mode.
Limited SEED	If enabled, disables the Seed transmission when the synchronization counter reaches 80 hex (128).
Sync Counter	Depending on the <i>Counter Select</i> option enter a 16-bit or a 20-bit sync counter. This is the starting point of the sync counter.
Discrimination Value	You can opt for the default setting equal to the 10 LSbs of the serial number or enter an arbitrary 10-bit value (0 through 3FF).
Start/Stop Pulse Enable	If enabled, this option adds a Start bit (1) to the code word after the synchronization header and a Stop bit (1) after the last Status bit (end of the code word).
Queue Counter Enable	Activates the Queue status bits functionality. This allows an application to distinguish between single, double, triple and quadruple button presses.
Time-Out	If enabled, the device will shut off after transmitting continuously for a predetermined time. This prevents a complete battery discharge if an accidental input.
Low Voltage Select	Selects the voltage at which the VLOW flag (bit) is set in a transmission.
Wake-Up Select	Selects the length and duty cycle of an optional extra Wake-Up preamble, transmitted before the first code word.
PLL Interface Select	Choose between ASK and FSK for the PLL Interface.
Minimum Code Words	Used to select the minimum number of code words transmitted when the device is activated.

KEELOQ® 3 Development Kit User's Guide

TABLE 3-2: PIC16F636 TRANSMITTER CONFIGURATION TRADITIONAL KEELOQ OPTIONS

Counter Select	Selects the Synchronization Counter size to be the standard 16-bit or extended to 20-bit.
Dual Encoder Enable*	Makes the S3 pin act as a SHIFT input to select between (sub) encoder #1 and #2 activation.
Low Voltage Latch	If enabled, Low battery indication is latched on the first occurrence and remains so until the battery is changed (i.e., power cycled).
RF Enable	If enabled, this option will produce a high output on the S3 pin to use as an Enable signal for ASK PLL transmitter circuits. The S3 pin will still be available as a button input, but its de-bouncing and repeat timing functionality will be affected; its use cannot be recommended for frequent function codes use.

For the PIC16F636 software encoder, the KEELOQ plug-in uses the following memory map:

TABLE 3-3: MEMORY MAP

Memory location	Description	Encoder
0x00 = A 0x01 = B 0x02 = C	Sync counter. MSB first.	Encoder 1
0x03 = B XOR C 0x04 = A XOR B 0x05 = A XOR C	Checksums for sync counter.	
0x08 = A 0x09 = B 0x0A = C	Sync counter. MSB first.	Encoder 2
0x0B = B XOR C 0x0C = A XOR B 0x0D = A XOR C	Checksums for sync counter.	
0x10 0x11 0x12 0x13	32-bit serial number. MSB first.	Encoder 1
0x14 0x15 0x16 0x17 0x18 0x19 0x1A 0x1B	4-bit seed code + 60-bit seed. MSB first	
0x1C	: --- --10 Discrimination value first 2 MSB : --- 32-- Transmission Modulation Format : ---4 --- Header Select : --5- --- Extended Serial Number : -6- --- Queue counter : 7--- --- Start/Stop Pulse Enable	
0x1D	Discrimination value 8 LSB	
0x1E 0x1F 0x20 0x21 0x22 0x23 0x24 0x25	64-bit encryption key. MSB first	

Using the KEELOQ 3 Development Kit MPLAB Plug-In

TABLE 3-3: MEMORY MAP (CONTINUED)

0x26 0x27 0x28 0x29	32-bit serial number. MSB first.	Encoder 2
0x2A 0x2B 0x2C 0x2D 0x2E 0x2F 0x30 0x31	4-bit seed code + 60-bit seed. MSB first	
0x32	: ---- --10 Discrimination value first 2 MSB : ---- 32-- Transmission Modulation Format : ---4 ---- Header Select : --5- ---- Extended Serial Number : -6-- ---- Queue counter	
0x33	Discrimination value 8 LSB	
0x34 0x35 0x36 0x37 0x38 0x39 0x3A 0x3B	64-bit encryption key. MSB first	
0x3C	: ---- ---0 Limited Seed : ---- --1- Seed Mode : ---- 32-- Time Before Seed Code : --54 ---- Transmission Baud Rate : 76-- ---- Guard Time Select	Encoder 1
0x3D	Device Options: : ---- --10 Minimum Code Words Value : ---- -2-- Dual Encoder : ---- 3--- RF Enable Output Select : --54 ---- Time-out Select Value2 Time(s) 2.0 : -6-- ---- Low Voltage LED Blink (Encoder 2) : 7--- ---- LED On Time Select (Encoder 2)	Device options
0x3E	: ---- ---0 Limited Seed : ---- --1- Seed Mode : ---- 32-- Time Before Seed Code : --54 ---- Transmission Baud Rate : 76-- ---- Guard Time Select	Encoder 2
0x3F	Device options: : ---- --10 Wake-up : ---- -2-- Counter Select : ---- 3--- Low Voltage Latch Enable : ---4 ---- Low Voltage Trip Point Select : --5- ---- PLL Interface Select : -6-- ---- Low Voltage LED Blink (Encoder 1) : 7--- ---- LED On Time Select (Encoder 1)	Device options

Once you have selected all the required options you can export the memory map to the EEPROM memory by pressing the EEPROM export button.



3.8 MEMORY MAP FOR XTEA/AES

The full version of the plug-in has the capability of programming the memory maps for a KEELOQ/XTEA and KEELOQ/AES transmitter. The full version plug-in advanced transmitter application notes are contained in the CD "Advanced Security Algorithms for KEELOQ Systems" (DS51813).

FIGURE 3-2: KEELOQ[®] CODE CALCULATOR

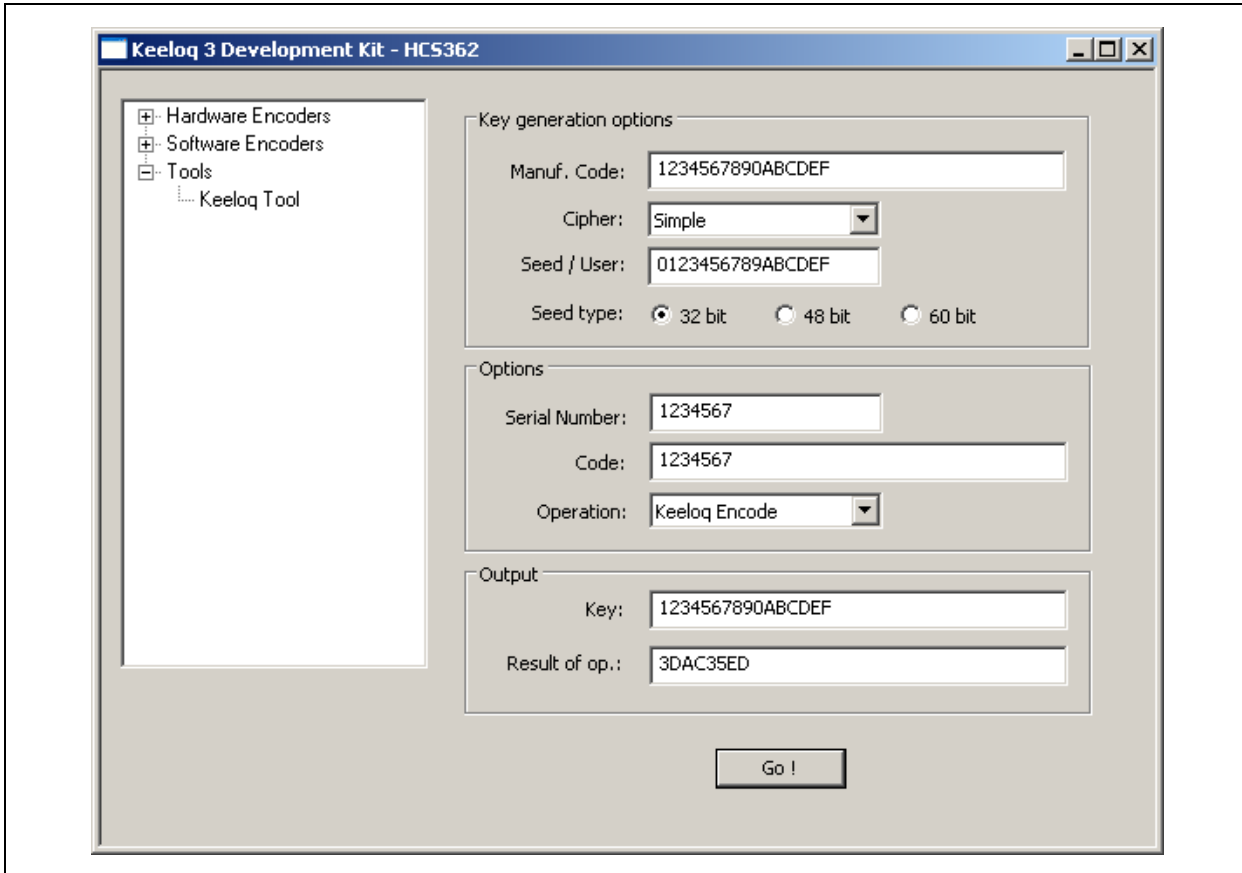

The KEELOQ code calculator is a tool that can encrypt and/or decrypt a 32-bit value, based on a 64-bit encryption key.

The encryption key can be also calculated based on several key generation algorithms; a manufacturer code, a serial number and/or a seed value. For key generation algorithms that are based on a seed value, there are three buttons to select between 32, 48 or 60-bit seed value. Depending on the seed length, the key generation algorithm changes accordingly.

Chapter 4. Using the I²C[™] GUI Interface Demo Tool

4.1 INTRODUCTION

The I²C[™] Graphical User Interface is a PC software tool used to communicate with the Controller board.

Note: A PICkit[™] Serial Analyzer P/N DV164122 (sold separately) is required to perform the functions specified in this chapter.

The connection with the KEELOQ[®] 3 Development Kit Controller is done with a PICkit Serial Analyzer module. The Controller board features a PICkit Serial compatible, 6-pin header for direct connection to the PICkit Serial Analyzer.

FIGURE 4-1: PICkit[™] SA CONNECTION

**4.2 HIGHLIGHTS**

This chapter discusses:

- the I²C Graphical User Interface (GUI)
- how to use the I²C Graphical User Interface

4.3 OVERVIEW: INSTALLING THE I²C GRAPHICAL USER INTERFACE

Insert the KEELOQ 3 Development Kit CD-ROM into the CD-ROM drive. Browse the CD-ROM directory and find the Setup.exe file located in the I²C GUI folder.

Follow the direction on the screen to install the I²C Graphical User Interface.

KEELOQ[®] 3 Development Kit User's Guide

MPLAB IDE is not required to run this software.

Note: The I²C Graphical User Interface requires the Microsoft[®] .NET Framework Version 2.0

4.4 INTERFACE WINDOW

Below is a screenshot of the GUI window (Figure 4-2). This GUI makes use of the PICkit Serial Analyzer in Master I²C mode. The controller board is configured to function as an I²C slave node.

FIGURE 4-2: THE GUI WINDOW



If the connection to the controller board is correct, then the message box in the middle will read (Figure 4-3):

FIGURE 4-3: MESSAGE BOX READING

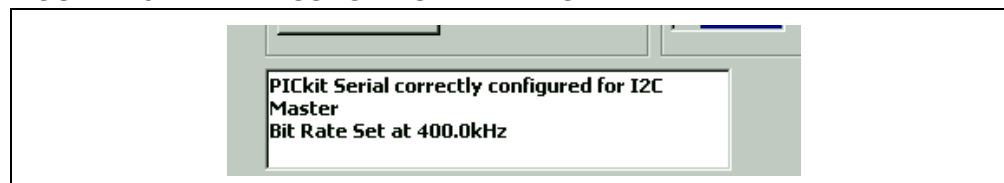

Using the I²C™ GUI Interface Demo Tool

The GUI interface gives the user the following options to interact with the controller board:

- Reset the PICkit Serial (to reset communications)
- Receiver Test: for testing communications
- Clear Message: Clears message box
- Individual Read Request and Continuous Read (every 300 ms)
- Receiver Commands: Erase and Learn Transmitter
- LED control

4.5 RESETTING THE PICKIT™ SERIAL

Press the **RESET PKSA** button to establish communications to the PICkit Serial Analyzer either at start-up or when a communications problem has arisen.

4.6 COMMUNICATIONS TEST

This command sends predefined data to the controller board. This data is displayed on the controller LCD as:

Test Buffer
01234567

Use this command to verify the integrity of the communication.

4.7 ERASING AND LEARNING TRANSMITTERS

To erase all transmitters learned by the Controller board click the **ERASE ALL** check box, then click on the **Transmit** button. A message on the text box will display if the erase command was successful.

To Learn a transmitter, click the **LEARN TRANSMITTER** check box, then click on the **Transmit** button. A message on the text box will display if the learn command was successful.

4.8 RECEIVING DATA

Two receiving modes are available: on demand and continuous.

When clicking on the **Read Request** button, a single read command is sent through to the controller board. The controller will send the decoded information of the last transmission received.

Checking the **Continuous Read** box will send a read request to the controller board every 300 ms. The information on the current last transmission is sent to the GUI at this rate.

FIGURE 4-4: SERIAL NUMBER AND DECRYPTED INFORMATION DISPLAY

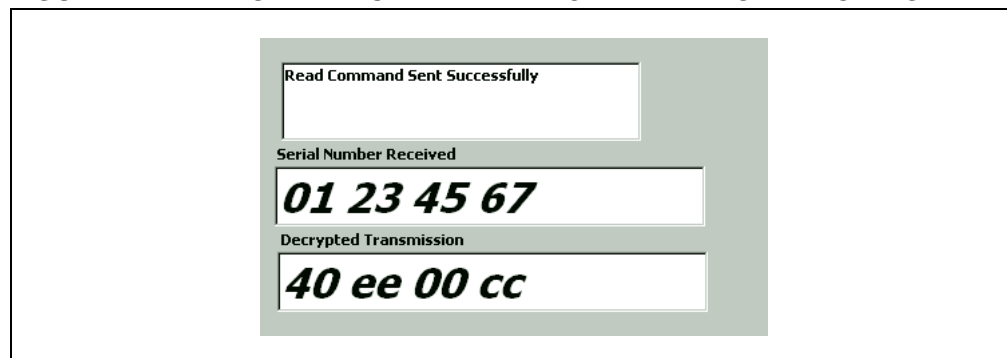

4.9 LED COMMANDS

Checking the desired LED boxes and pressing the **Transmit** button will turn on or off the requested LEDs.

4.10 I²C[™] COMMUNICATIONS – SUMMARY OF COMMANDS

All PICkit Serial communications with the controller board are done using the PICkit Serial as a master node, using the I²C communication protocol.

This is the set of I²C specific commands used to communicate with the controller board.

01 Test I²C Buffer

This command sends a string of characters to the controller for display on the LCD. The characters are transmitted in 4 bytes of data. When the GUI "Receiver Test" is pressed, the LCD on the controller board should read "Test Buffer 01234567".

02 LED ON/OFF

This is the command to turn the LEDs on or off. The lower nibble of the byte received after the command indicates which LEDs turn on or off. Pressing the transmit button on the GUI without checking any LED boxes will turn off the LEDs.

03 TX buffer for transponder application (not implemented in this revision).

04 Receiver command

The next byte following the receiver command indicates a specific receiver activity:

01 (Learn Transmitter) tells the controller to enter Learn mode

02 (Erase Transmitters) tells the controller to erase all previously learned transmitters.

For more information on I²C and KEELOQ decoding application, please refer to the application note AN1248, "*PIC MCU-Based KEELOQ Receiver System Interfaced via I²C*".

Chapter 5. KEELOQ[®] Development Kit Controller

5.1 INTRODUCTION

This chapter describes the basic user hardware interaction with the controller board.

5.2 HIGHLIGHTS

This chapter discusses:

- PICkit™ Serial connection
- PICkit 2 Programmer connection
- Receiver Board Selection Jumper
- LCD Display
- Radio Receiver
- Main Processor
- Prototyping Area
- Power Supply

5.3 PICKIT SERIAL PIN ASSIGNMENTS

The PICkit Serial connection header is designed to allow a PICkit serial to be connected to the controller board. The communication is done using the I²C™ standard, in which case the PICkit Serial Analyzer is the master device and the board acts as a slave I²C device.

The pin assignments are shown in Figure 5-1.

FIGURE 5-1: PIN ASSIGNMENTS

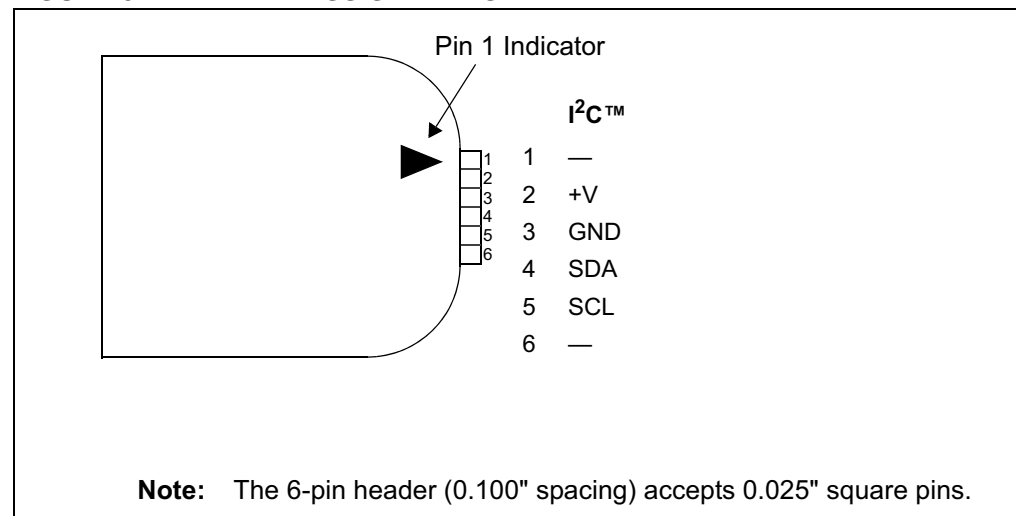

KEELOQ[®] 3 Development Kit User's Guide

5.4 PICKit 2 PIN ASSIGNMENTS

The PICKit 2 connection header allows a PICKit 2 microcontroller programmer to be connected directly to the controller to allow programming and/or debugging of the controller. Other programmer/debuggers can be connected, though an RJ-11 to ICSP adapter might be necessary.

The pin assignments are shown in Figure 5-2.

FIGURE 5-2: PICKit™ 2 PIN ASSIGNMENTS

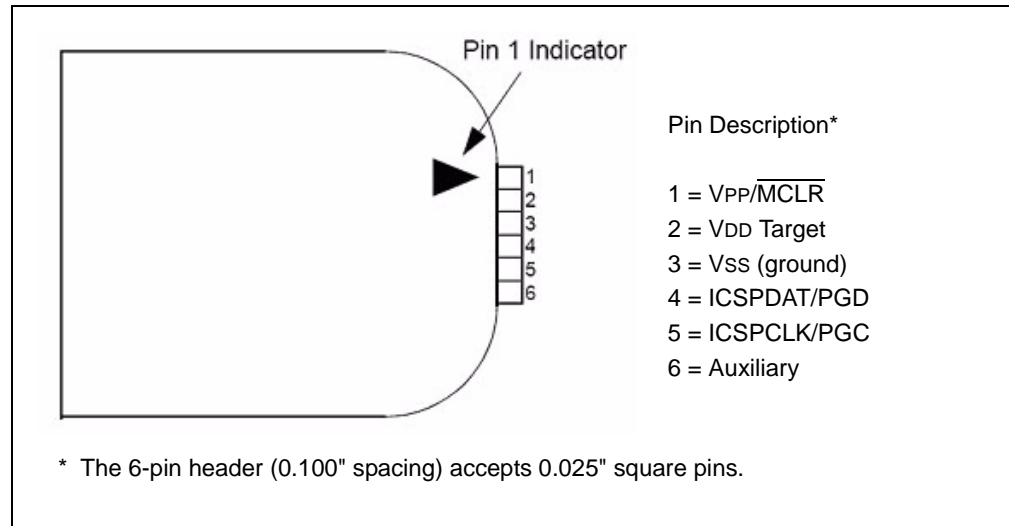

5.5 LEARNING A TRANSMITTER TO THE CONTROLLER

In order for the system to respond to incoming radio transmission from one of the KEELOQ transmitters, the controller must have information about the respective transmitters. Such information includes the serial number and the synchronization counter.

In order to learn a new transmitter:

- Press the **PB3** button on the controller. As a confirmation, the D4 LED will turn on.
- Press one button on the transmitter. If the transmitter is correctly programmed, the D4 LED will begin blinking.
- Press again any button on the transmitter. If the learning process was successful, the D4 LED will turn off.
- As of now, the controller will be able to respond to the learned transmitter. This is confirmed by the D1-D4 LEDs corresponding to the four buttons on the remote control.

5.6 RECEIVER BOARD SELECTOR PIN

The controller board contains an ASK radio receiver module. The pinout corresponds to the standard PICtail™ connector. Thus, it may be easily replaced with similar models accommodating other frequencies, modulation methods (ASK vs. FSK) as well as adapting transponder boards for two-way communication.

On the controller board there is a jumper (J5) that allows for receiver card selection. The KEELOQ 3 Development Kit is supplied with the ASK receiver board. Optionally, an FSK transceiver card is available. The jumper configuration is:

- ASK receiver board: pins 1 and 2 connected, jumper to the left side
- FSK board: pins 2 and 3 connected, jumper to the right side.
- J5 also allows the radio receiver output to be disconnected from the main processor. This permits monitoring the receiver output on an oscilloscope or injecting an encoder's digital output directly into the decoder.

5.7 PICtail™ CONNECTOR

The board features two connectors. One 14 pin is dedicated for the receiver modules. While the connector has 14 pins, not all the pins are used. The ASK receiver board only uses the following pins:

- Pin 11 – RF data out
- Pin 13 – VDD 5V
- Pin 14 – GND

The board also features a 28-pin connector that provides an easy access to all of the PIC16F886 pins.

5.8 LCD DISPLAY

A 2-line by 16 characters LCD display is present on the board. It is used to display. When the controller receives a KEELOQ transmission, the serial code and the decrypted data will be shown on the display. The LCD contrast can be adjusted by the contrast pot located on the bottom side of the controller board, near push button **PB1**.

5.9 MAIN PROCESSOR

The main processor contains a SOIC PIC16F886 operating at 8 MHz. The microcontroller provides connections for the LCD display, programming, push buttons, LEDs and RF board control. Please refer to the schematic in **Appendix A. “KeeLoq[®] 3 Development Kit Schematics”** for further information.

5.10 POWER SUPPLY AND PROTOTYPING AREA

The power supply circuit is designed to regulate a maximum current of 100 mA at 5V from an external 9V power supply.

The prototyping area includes convenient VDD. and GND through hole strips to power custom circuitry. The user must ensure that the Prototype area custom circuit current draw added to the controller board consumption does not exceed the 100 mA total limit.

KEELOQ[®] 3 Development Kit User's Guide

NOTES:

Chapter 6. KEELOQ[®] Development Kit Controller Firmware

6.1 INTRODUCTION

The controller is the heart of the KEELOQ[®] 3 Development kit. It is the receiving side of the KEELOQ system. In order for the system to respond to incoming radio transmission from one of the KEELOQ transmitters, the controller must have information about the respective transmitters.

Such information includes the serial number and the synchronization counter. Both are very important pieces of information and present the root of the KEELOQ decoding. The learning procedure is explained in **Section 5.5 “Learning a Transmitter to the Controller”**.

6.2 HIGHLIGHTS

This chapter discusses:

- Overview of the firmware running on the controller
- Data packet receiving
- KEELOQ Decryption
- I²C[™] communication

6.3 KEELOQ DATA PACKET RECEIVING

The data packet section of the controller firmware receives and decodes PWM modulated KEELOQ transmissions. This routine only checks for and decodes KEELOQ transmissions coming from the radio receiver module.

PWM Format

In general, all KEELOQ encoders share a common transmission format:

- A preamble to improve biasing of decision thresholds in super-regenerative receivers. The preamble consists of alternate on and off periods, each lasting as long as a single elemental period.
- A calibration header consisting of a low period of 10 elemental periods. Calibration actions should be performed on the low period of the header to ensure correct operation with header chopping.
- A string of pulse-width modulated bits, each consisting of three elements. The first element is high, the second contains the data transmitted and is either high or low, and the third element is always low.
- A guard period is usually left between the transmissions. During this period nothing is transmitted by the encoder.

FIGURE 6-1: KEELOQ® PWM TRANSMISSION FORMAT

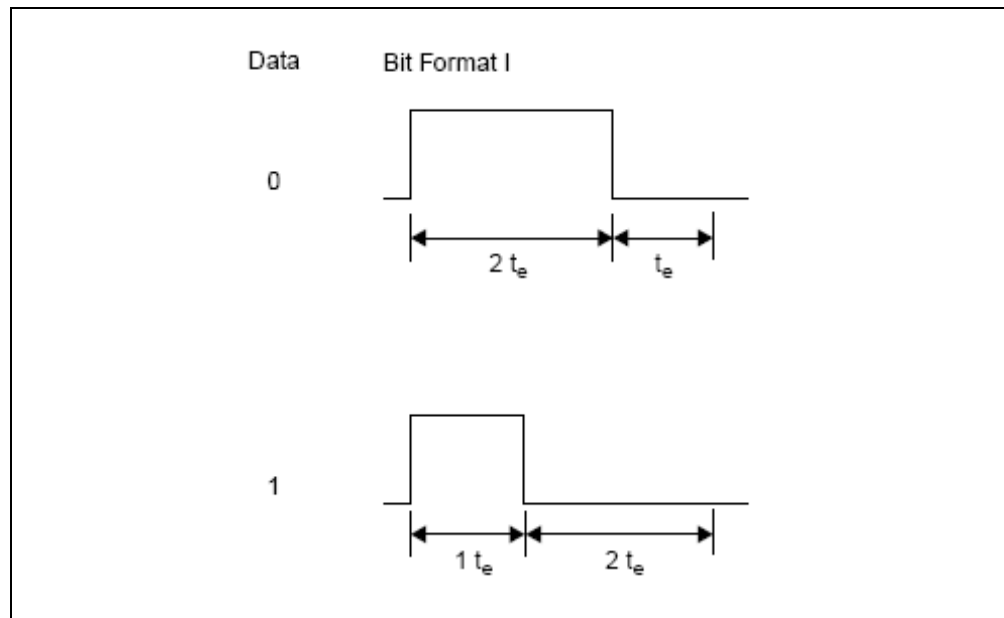

6.4 KEELOQ DECRYPTING

The controller will automatically decrypt and display information on any incoming traditional KEELOQ, AES or XTEA radio packet received by the radio receiver module. The validity of the data will be dependent on the encryption keys used to encode the information on the transmitter.

Decryption is done using the normal key generation algorithm based on the controller manufacturer code. The source code is available on the KEELOQ 3 Development Kit CD-ROM.

6.5 I²C COMMUNICATION

The I²C connection header allows a PICKit Serial Analyzer module to be connected to the controller board. The controller supports a set of commands that allows the controller to function as a truly I²C KEELOQ decoder. The I²C master device (the PICKit Serial Analyzer in this case) can instruct the controller to learn and delete transmitters, and to read transmission. Some debug commands are also present (e.g., LED test), see **Section 4.10 “I²C™ Communications – Summary of Commands”**.

6.6 LCD DISPLAY

The LCD will display the serial number and the encrypted section (already decrypted) of the last received transmission. When a new transmission is received, the display is automatically updated.

Chapter 7. KEELOQ[®] Development Kit PIC16F636 Transmitter

7.1 INTRODUCTION

The KEELOQ[®] 3 Development Kit PIC16F636 transmitter is a SAW-based, short range, low-cost OOK (on-off keying) transmitter. The KEELOQ encoding is done on the PIC16F636 microcontroller. The PIC16F636 features an internal KEELOQ encryption peripheral, which eases encoding code development. All encoder data is stored in the PIC16F636 internal EEPROM.

7.2 HIGHLIGHTS

This chapter discusses:

- Main features of the PIC16F636 transmitter
- KEELOQ software encoder source code

7.3 MAIN FEATURES

The PIC16F636 transmitter is a software-based device. The KEELOQ encoder source code is available under the KEELOQ encoder license. Thus, the user has complete freedom in designing their own custom solution. While the kit comes with specific software, there is basically no limitation in modifying the source code to create custom encoding schemes.

In addition, the PIC16F636 based transmitter can support an 8 or 14-pin socket for use with code development with other PIC[®] devices. The four buttons (S0... S3) on the transmitter are connected to input pins on the microcontroller. The user may activate any combination of buttons transmitting any of the 15 possible function codes.

Header J2 (unpopulated) can be used for further development or for additional function codes for XTEA and AES encoding protocols.

The battery holder accepts one CR2032 3V lithium battery, positive side up. The RF oscillator circuit is designed to operate at this voltage.

Some of the features of the software-based PIC16F636 KEELOQ encoder are:

- Two programmable 32-bit serial numbers
- Two programmable 64-bit crypt keys
- Two programmable 60-bit seed values
- Four button inputs
- Four selectable baud rates
- PWM, VPWM, PPM and Manchester modulation

The included CD also contains software for a KEELOQ/XTEA and KEELOQ/AES encoder, which include a larger serial number and crypt keys. All other functionality remains the same.

7.4 PICKit™ 2 PIN ASSIGNMENTS

The 6-pin header is compatible with the PICKit 2 microcontroller programmer and allows direct connection to it. The pin assignment is:

TABLE 7-1: PICKit™ 2 PIN ASSIGNMENTS

1	$\overline{\text{MCLR}}/\text{VPP}$
2	VDD
3	GND
4	ICSPDAT
5	ICSPCLK
6	NC

7.5 PROGRAMMING THE TRANSMITTER

Programming the transmitter can be done using the PICKit 2 microcontroller programmer along with the supplied software. The MPLAB KEELOQ plug-in allows fully configuration and programming of the transmitter.

7.6 TRANSMITTER FIRMWARE

The PIC16F636 transmitter is based on a KEELOQ encoder firmware and thus, it is a software encoder. The source code is available on the KEELOQ 3 Development Kit CD-ROM.

Chapter 8. Troubleshooting

8.1 INTRODUCTION

Here you should find the needed information in case anything does not work as it should.

8.2 FREQUENTLY ASKED QUESTIONS

Q: The controller cannot learn a transmitter.

A: Most likely the transmitter is not programmed correctly.

Q: Can an HCS device be programmed while MPLAB[®] IDE already has a loaded project?

A: Yes, provided that the programmer hardware is only selected for the KEELOQ plug-in and the MPLAB main software uses another programmer (or none).

Q: Is the KEELOQ plug-in able to program a PIC16F636 with encoder firmware?

A: No, you need to load the source code project first. For the PIC16F636, the KEELOQ plug-in can only export EEPROM data.

KEELOQ[®] 3 Development Kit User's Guide

NOTES:

Appendix A. KEELOQ[®] 3 Development Kit Schematics

FIGURE A-1: LAYOUT OF THE KEELOQ EVALUATION KIT III CONTROLLER BOARD

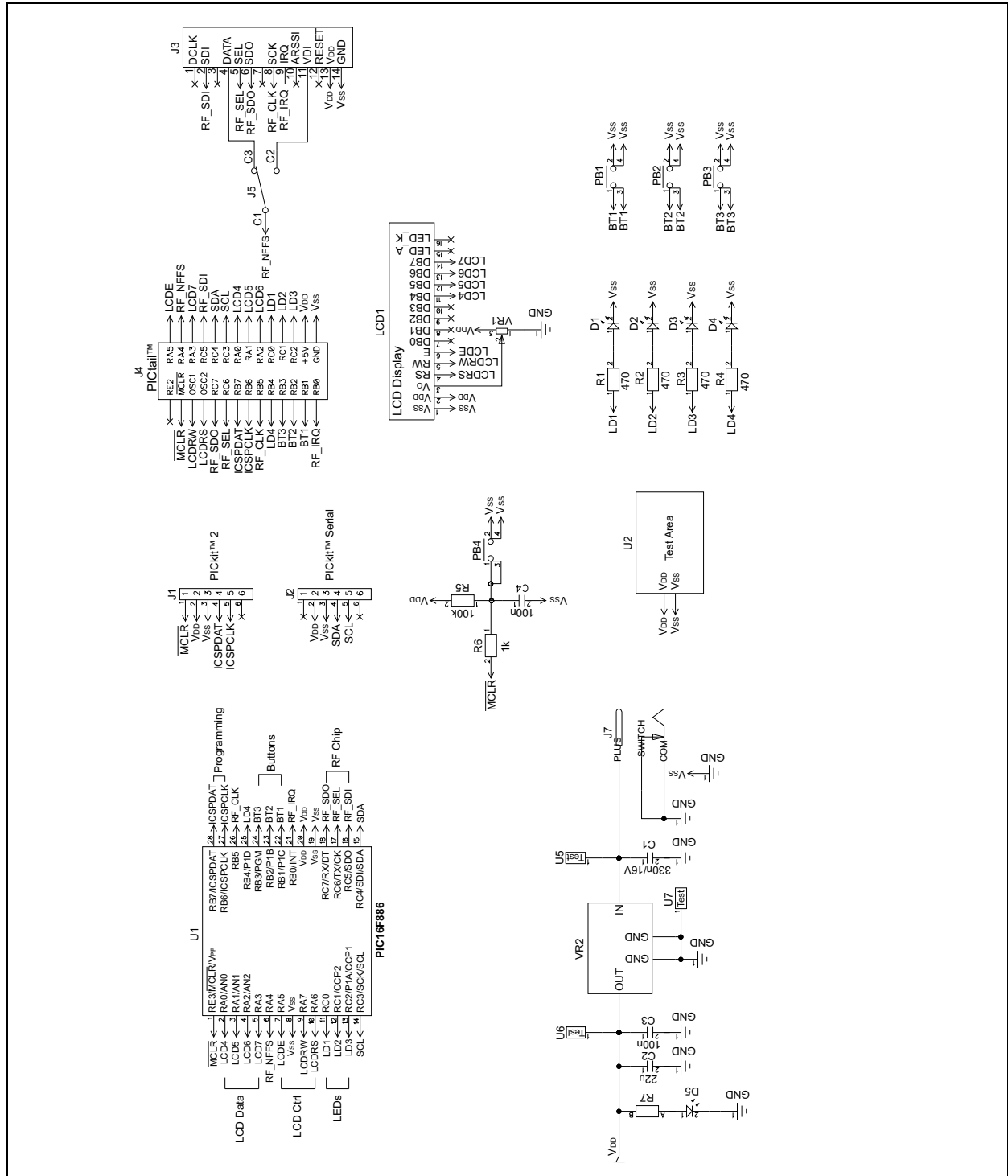

KEELOQ® 3 Development Kit User's Guide

FIGURE A-2: RECEIVER BOARD

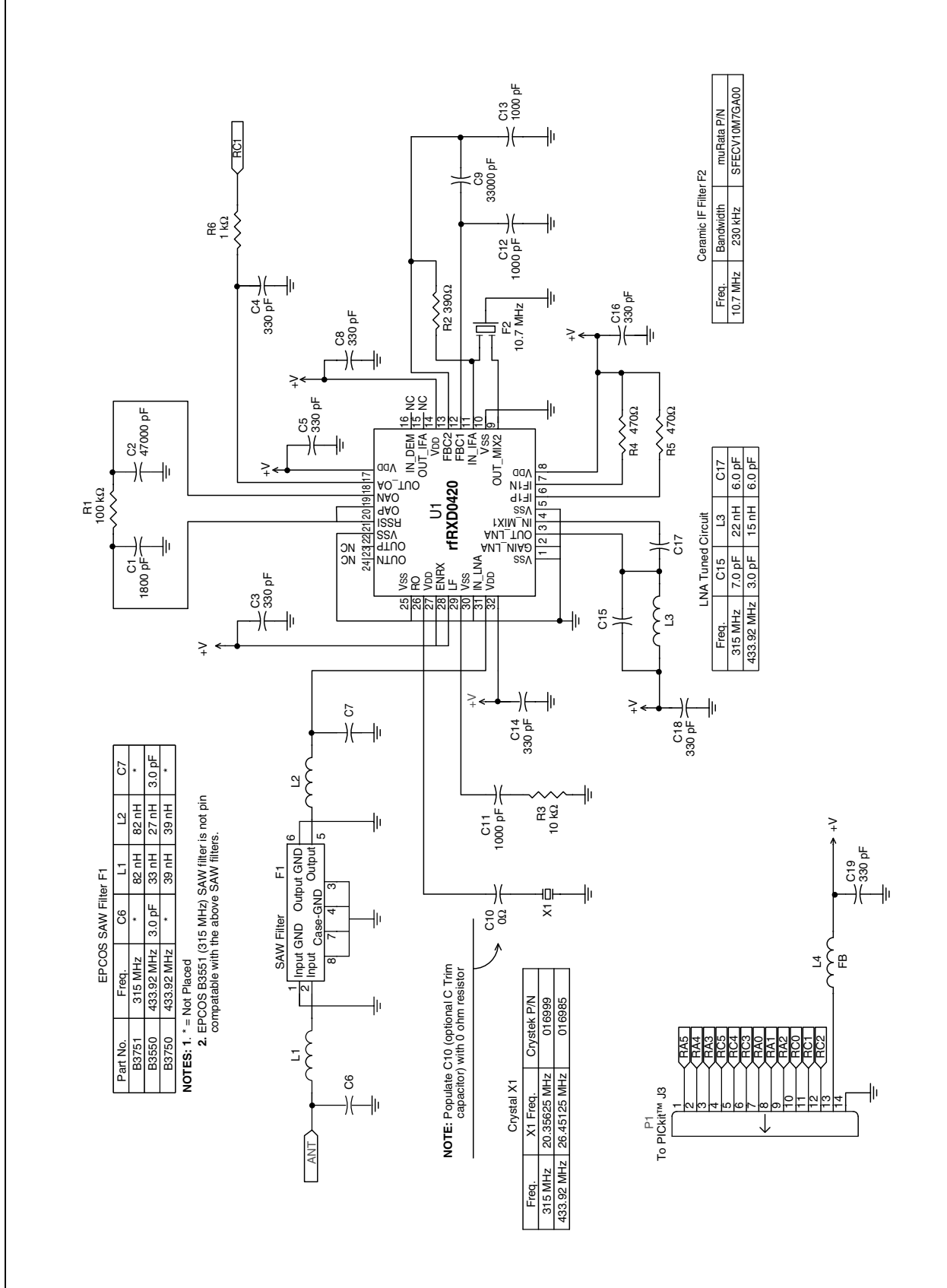

KEELOQ[®] 3 Development Kit Schematics

FIGURE A-3: HCS362 HARDWARE ENCODER TRANSMITTER BOARD

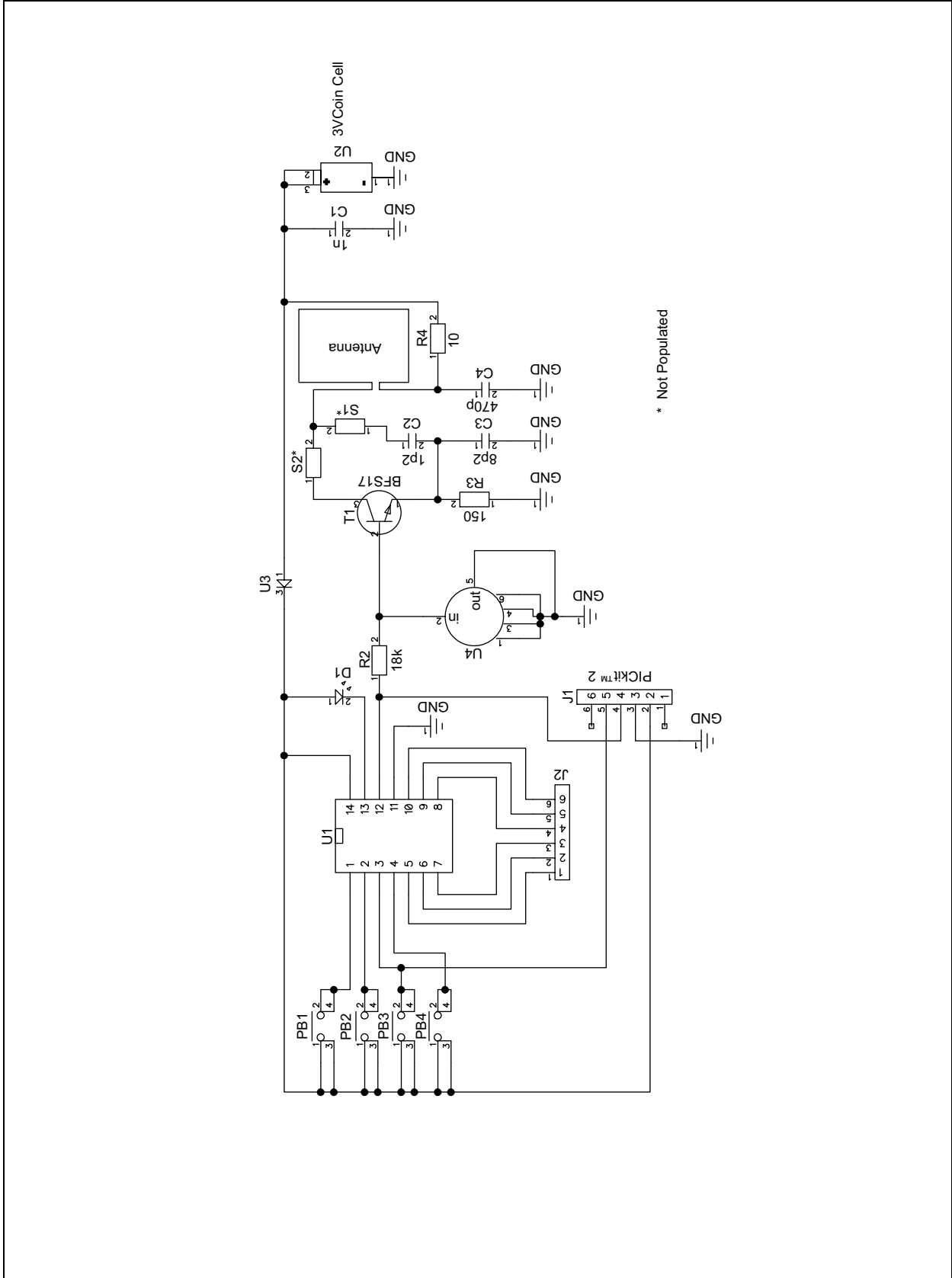

KEELOQ[®] 3 Development Kit User's Guide

FIGURE A-4: PIC16F636 SOFTWARE ENCODER TRANSMITTER BOARD

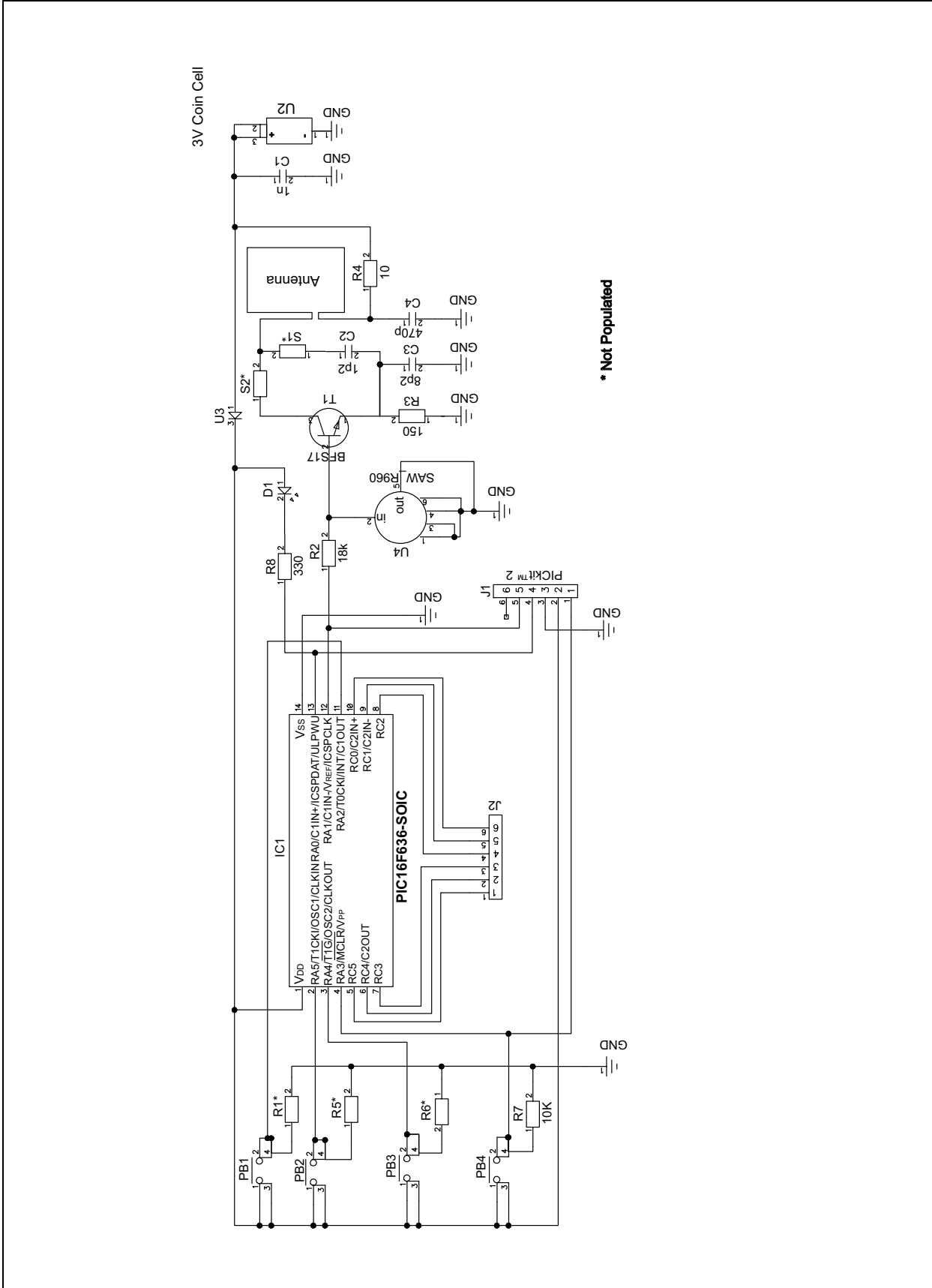

KEELOQ[®] 3 Development Kit User's Guide

NOTES:



WORLDWIDE SALES AND SERVICE

AMERICAS

Corporate Office
2355 West Chandler Blvd.
Chandler, AZ 85224-6199
Tel: 480-792-7200
Fax: 480-792-7277
Technical Support:
<http://support.microchip.com>
Web Address:
www.microchip.com

Atlanta
Duluth, GA
Tel: 678-957-9614
Fax: 678-957-1455

Boston
Westborough, MA
Tel: 774-760-0087
Fax: 774-760-0088

Chicago
Itasca, IL
Tel: 630-285-0071
Fax: 630-285-0075

Cleveland
Independence, OH
Tel: 216-447-0464
Fax: 216-447-0643

Dallas
Addison, TX
Tel: 972-818-7423
Fax: 972-818-2924

Detroit
Farmington Hills, MI
Tel: 248-538-2250
Fax: 248-538-2260

Kokomo
Kokomo, IN
Tel: 765-864-8360
Fax: 765-864-8387

Los Angeles
Mission Viejo, CA
Tel: 949-462-9523
Fax: 949-462-9608

Santa Clara
Santa Clara, CA
Tel: 408-961-6444
Fax: 408-961-6445

Toronto
Mississauga, Ontario,
Canada
Tel: 905-673-0699
Fax: 905-673-6509

ASIA/PACIFIC

Asia Pacific Office
Suites 3707-14, 37th Floor
Tower 6, The Gateway
Harbour City, Kowloon
Hong Kong
Tel: 852-2401-1200
Fax: 852-2401-3431

Australia - Sydney
Tel: 61-2-9868-6733
Fax: 61-2-9868-6755

China - Beijing
Tel: 86-10-8528-2100
Fax: 86-10-8528-2104

China - Chengdu
Tel: 86-28-8665-5511
Fax: 86-28-8665-7889

China - Hong Kong SAR
Tel: 852-2401-1200
Fax: 852-2401-3431

China - Nanjing
Tel: 86-25-8473-2460
Fax: 86-25-8473-2470

China - Qingdao
Tel: 86-532-8502-7355
Fax: 86-532-8502-7205

China - Shanghai
Tel: 86-21-5407-5533
Fax: 86-21-5407-5066

China - Shenyang
Tel: 86-24-2334-2829
Fax: 86-24-2334-2393

China - Shenzhen
Tel: 86-755-8203-2660
Fax: 86-755-8203-1760

China - Wuhan
Tel: 86-27-5980-5300
Fax: 86-27-5980-5118

China - Xiamen
Tel: 86-592-2388138
Fax: 86-592-2388130

China - Xian
Tel: 86-29-8833-7252
Fax: 86-29-8833-7256

China - Zhuhai
Tel: 86-756-3210040
Fax: 86-756-3210049

ASIA/PACIFIC

India - Bangalore
Tel: 91-80-3090-4444
Fax: 91-80-3090-4080

India - New Delhi
Tel: 91-11-4160-8631
Fax: 91-11-4160-8632

India - Pune
Tel: 91-20-2566-1512
Fax: 91-20-2566-1513

Japan - Yokohama
Tel: 81-45-471- 6166
Fax: 81-45-471-6122

Korea - Daegu
Tel: 82-53-744-4301
Fax: 82-53-744-4302

Korea - Seoul
Tel: 82-2-554-7200
Fax: 82-2-558-5932 or
82-2-558-5934

Malaysia - Kuala Lumpur
Tel: 60-3-6201-9857
Fax: 60-3-6201-9859

Malaysia - Penang
Tel: 60-4-227-8870
Fax: 60-4-227-4068

Philippines - Manila
Tel: 63-2-634-9065
Fax: 63-2-634-9069

Singapore
Tel: 65-6334-8870
Fax: 65-6334-8850

Taiwan - Hsin Chu
Tel: 886-3-6578-300
Fax: 886-3-6578-370

Taiwan - Kaohsiung
Tel: 886-7-536-4818
Fax: 886-7-536-4803

Taiwan - Taipei
Tel: 886-2-2500-6610
Fax: 886-2-2508-0102

Thailand - Bangkok
Tel: 66-2-694-1351
Fax: 66-2-694-1350

EUROPE

Austria - Wels
Tel: 43-7242-2244-39
Fax: 43-7242-2244-393

Denmark - Copenhagen
Tel: 45-4450-2828
Fax: 45-4485-2829

France - Paris
Tel: 33-1-69-53-63-20
Fax: 33-1-69-30-90-79

Germany - Munich
Tel: 49-89-627-144-0
Fax: 49-89-627-144-44

Italy - Milan
Tel: 39-0331-742611
Fax: 39-0331-466781

Netherlands - Drunen
Tel: 31-416-690399
Fax: 31-416-690340

Spain - Madrid
Tel: 34-91-708-08-90
Fax: 34-91-708-08-91

UK - Wokingham
Tel: 44-118-921-5869
Fax: 44-118-921-5820