

# Programmable Six Channel Sequencer and Voltage Supervisor with EEPROM

## DESCRIPTION

Demonstration circuit 2313A showcases the [LTC2937](#), a programmable six channel power supply sequencer and voltage supervisor.

The LTC2937 provides flexible sequence control for up to six power supplies. It enables and disables the supplies with configurable sequence order and time delays, monitors the supplies for power-up and power-down time, and for overvoltage and undervoltage. It cooperates with other LTC2937 parts in the system to coordinate power sequencing activities. It provides flexible fault response to autonomously supervise the power supplies, and powerful debug tools to diagnose any problem that causes a power-supply fault. It holds configuration in non-volatile EEPROM for completely automatic power system supervision.

The DC2313A board demonstrates the powerful features of the LTC2937 using six onboard LDO voltage regulators, or by controlling an optional, externally-powered

DC1361 board (an 8-channel power supply board). Multiple DC2313A boards can also share timing and sequencing signals to supervise more than six regulated supplies in a coordinated manner.

The DC2313A connects to a PC through the DC1613 USB-to-I<sup>2</sup>C/SMBus/PMBus Controller. This connection enables the LTpowerPlay™ software, to have complete control over the LTC2937 through the convenient LTpowerPlay GUI. The GUI allows control over all of the LTC2937 registers, and visibility into the status of the part in real time, and it works with Linear Technology demo boards as well as custom boards with an I<sup>2</sup>C interface.

**Design files for this circuit board are available at <http://www.linear.com/demo/DC2313A>**

LT, LT, LTC, LTM, Linear Technology and the Linear logo are registered trademarks and LTpowerPlay is a trademark of Linear Technology Corporation. All other trademarks are the property of their respective owners.

## PERFORMANCE SUMMARY

PARAMETER	CONDITIONS	MIN	TYP	MAX	UNITS
V <sub>IN</sub> Voltage Range	All	6	12	14	V
I <sub>IN</sub> Current to the Board	Sequenced-Down		3.8		mA
I <sub>IN</sub> Current	Sequenced-Up, No Loads		17.5		mA
V1-V6 Voltage Range	Volts at the Turret	0		6	V
EN1-EN6 Voltage Range	Volts at the Turret <sup>†</sup>	0		6	V
Regulated LDO Voltage Tolerance	Load Current < 20mA	-1		1	%
Rated Output Current *V <sub>OUT</sub> pins	Load Current Per Channel			20	mA
Board Operating Temperature	Powered	0		60	°C
Serial Clock Frequency	I <sup>2</sup> C Bus Operating	10		400	kHz

<sup>†</sup>NOTE: Analog switches U7, U8, and U9 (LTC222) are powered by 5V, and limit the maximum voltage range allowed at their S and D pins. The LTC2937 can tolerate up to 16.5V on its ENn pins.

# DEMO MANUAL DC2313A

## LTC2937 FEATURES

- Time and Event-Based Supply Sequencing
- 12 Programmable Undervoltage and Overvoltage Comparators (0.75% Accuracy)
- Stalled Power-Supply Detection
- Single Wire Synchronization Allows Controller Expansion to 50 Devices (300 Power Supplies)
- Configuration and Fault Logging in EEPROM
- EEPROM Rated to 85°C, 10k Writes, 20 Year Retention
- Supported by LTpowerPlay GUI
- Fault and System Status Registers
- Reset Output with Programmable Delay
- I<sup>2</sup>C/SMBus Interface
- Wide Input Supply Voltage Range: 2.9V to 16.5V
- 28-Pin QFN (5mm × 6mm) Package

## HOW TO USE THIS DOCUMENT

This demonstration manual introduces the LTC2937 through a series of simple exercises using the DC2313A demo board and the LTpowerPlay software. Each exercise introduces one or two key features of the part, as well as

recommended methods for interfacing to it. The LTC2937 has more useful features than can be covered here. The user is referred to the LTC2937 data sheet, and to additional exercises in the DC2313A Advanced User Guide document.

## THE DC2313A BOARD

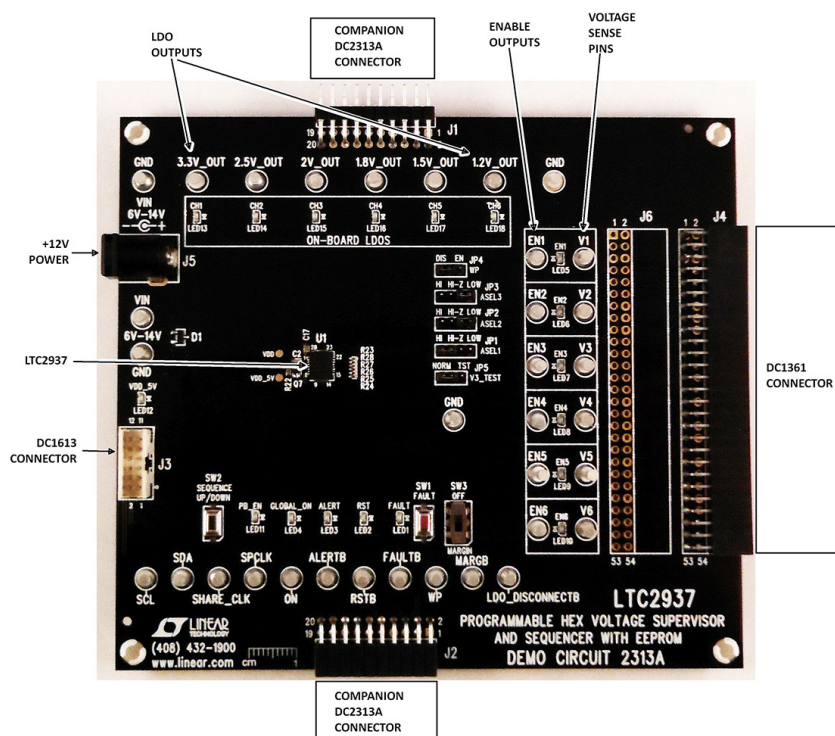

Figure 1. DC2313A Board

dc2313af

## DC2313 OPERATING PRINCIPLES

The DC2313A board is fully functional as a stand-alone evaluation platform for the LTC2937, and does not require any external connections, other than power. It provides convenient access to all of the LTC2937 pins through turrets on the board, and basic control over the part by jumpers and pushbuttons. Connectors can attach to external devices for system prototyping. The board has six LDO regulators that respond to control from the LTC2937, and demonstrate its capabilities.

Additional functionality is accessible using the DC1613 USB-to-I<sup>2</sup>C “dongle” and LTpowerPlay software running on a PC. The software provides a detailed view of the functions of the LTC2937, including powerful fault management and debug capabilities.

### POWERING

The DC2313 can draw power from one of two sources. Either 5V from the DC1613 ribbon cable connected to J3, or from the V<sub>IN</sub> connector to 12V. The DC1613 can only supply 100mA, so when the board draws power from 5V do not load any of the LDO outputs, as this may overload the 5V supply. 12V must be used when loading the LDO outputs. Multiple DC2313A boards connected together through J1 and J2 share power through the connectors, so attach 12V and the ribbon cable to one of multiple DC2313A boards.

Only connect power to one of the boards. When the external DC1361 board is attached to connector J4, use 12V power.

### CONFIGURATION

A key feature of the LTC2937 is its non-volatile memory (EEPROM), and its ability to power-up in the correct configuration to autonomously sequence and supervise the power system. The DC2313A comes pre-programmed with default settings to demonstrate the sequencing and supervision capabilities of the LTC2937. The board functions with no intervention from LTpowerPlay or other software. The pre-programmed settings on the board are not the factory default settings for the LTC2937, but are intended to provide a useful demonstration platform, with observable timing relationships.

The LTC2937 communicates through the I<sup>2</sup>C bus on the J3 connector. Select a bus address by changing the jumpers ASEL1, ASEL2, and ASEL3. Each jumper can select either HI, Hi-Z, or LOW, and the three jumpers together select one of 27 addresses for the device. Select a unique address for each device on the I<sup>2</sup>C bus. If multiple DC2313 boards are connected together, each must have its own unique ASEL jumper setting. Each LTC2937 will always respond to its global 7-bit address 0x36. See the addressing section in the LTC2937 data sheet for a complete address table.

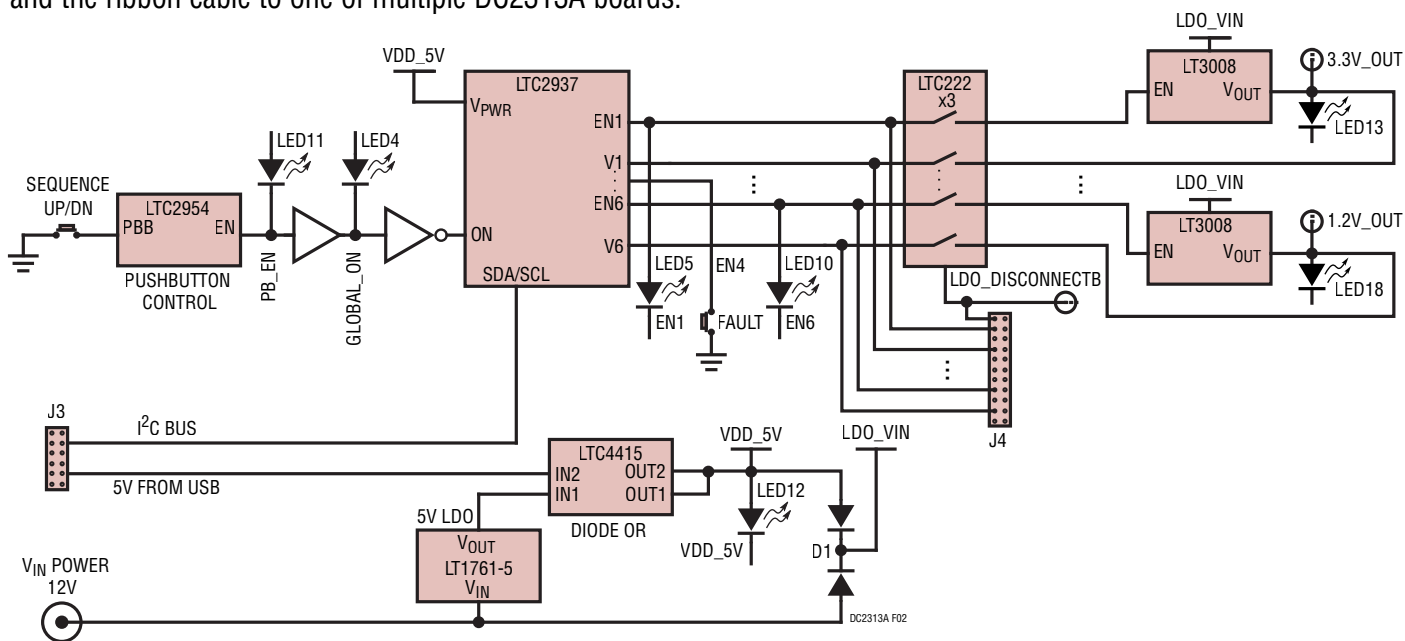

Figure 2. DC2313A Simplified Diagram

## QUICK START PROCEDURE (WITHOUT SOFTWARE)

Begin exploring the basic features of the LTC2937 with several exercises that do not require software. The following procedures assume a single DC2313A board with no DC1613 connected, and no LTpowerPlay running. The board will function autonomously without external software, which is one of the important capabilities of the LTC2937.

### SEQUENCING UP

Sequence up the supplies in an orderly fashion.

- 1) Apply power to the DC2313A by connecting 12V to the J5 power connector.

The  $V_{DD}$  and RSTB LEDs will illuminate; all other LEDs will be off.

- 2) Ensure that the SW3 switch is OFF, not in the MARGIN position.
- 3) Press the “SEQUENCE UP/DOWN” pushbutton on the DC2313.

The pushbutton is de-bounced by an LTC2954, which requires sufficient time to register the button press and activate the LTC2937 through the PB\_ENB signal.

The PB\_EN and GLOBAL\_ON LEDs will illuminate.

The ENn LEDs will illuminate in sequence: 1-6.

The CHn LEDs will illuminate in sequence with the ENn LEDs.

The RST LED will turn off when all supplies are within their OV/UV limits (after the last CHn LED illuminates).

The FAULT LED will remain off.

The ALERT LED will remain off.

The default voltage (UV and OV) limits and timing parameters should not detect faults.

The DC2313A is programmed to provide human eye observable sequence-up timing so that the time between supplies powering-up is easily observable via LEDs. The actual LTC2937 in-system sequence of events, and the delays between events are all configurable.

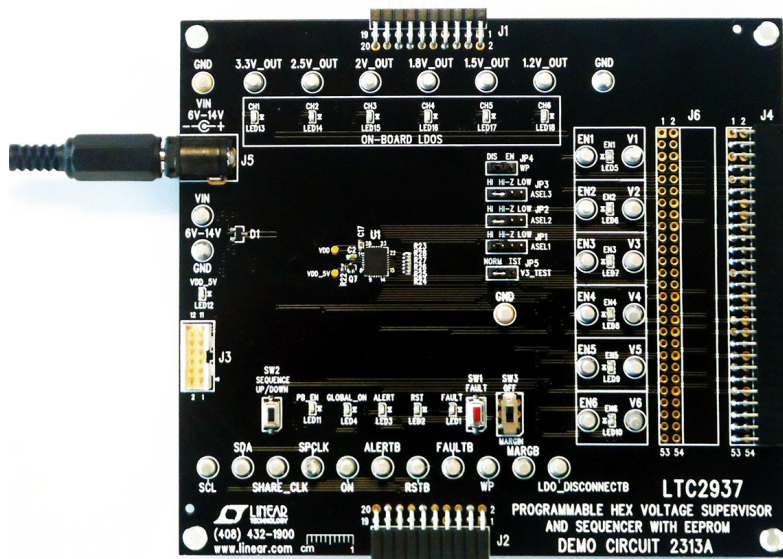

Figure 3. DC2313A Standalone

## QUICK START PROCEDURE (WITHOUT SOFTWARE)

### SEQUENCING DOWN

Bring down the supplies in an orderly fashion.

- 1) Begin with the system sequenced-up. The LDOs are on.
- 2) Press the “SEQUENCE UP/DOWN” pushbutton on the DC2313.

The PB\_EN and GLOBAL\_ON LEDs will turn off.

The ENn LEDs will turn off in sequence: 6-1.

The CHn LEDs will turn off in sequence with the ENn LEDs.

The RST LED will illuminate as soon as the CH6 LED goes off.

The FAULT LED will remain off.

The ALERT LED will remain off.

The default voltage (UV and OV) limits and timing parameters should not detect faults.

Notice that the sequence-down order of events is the reverse of the sequence-up order. Channels can be reconfigured easily via register programming to sequence-up and sequence-down in any order, and sequence-down order is independent of sequence-up order. As with sequencing-up, the human-friendly, eye-observable sequence timing is easily changed through register configuration.

### AUTONOMOUS FAULT HANDLING

A fault is any condition that should not exist in the system. The flexible LTC2937 is capable of autonomously recognizing and handling faults without software intervention. The LTC2937 recognizes 5 types of faults: SUPERVISOR fault, SEQUENCE fault, CONTROL fault, EXTERNAL fault, and SHARE\_CLK fault. We address SUPERVISOR and SEQUENCE faults here. For more information refer to the LTC2937 data sheet. The following examples, do not use software, or user/external intervention to recover from the fault condition. The LTC2937 is programmed to recover on its own.

Note that the LTC2937 ALERT pin requires a bus response to de-assert once it asserts low. When using the LTC2937 in fully autonomous mode, we ignore the ALERT pin, and

the ALERT LED on the board. Once it is asserted, ALERTB will remain asserted, and the ALERT LED illuminated. This is harmless.

### Supervisor Fault

A SUPERVISOR fault is caused by overvoltage (OV) detection during sequence-up, or by OV or undervoltage (UV) detection during normal operation (after a successful sequence-up). In this demo configuration the LTC2937 automatically detects the fault and re-starts all of the regulators.

Create this type of fault on the DC2313A board by pressing the FAULT pushbutton, which momentarily pulls down the EN4 line to GND, while in the sequenced-up state. This will briefly disable and bring down the associated LDO and create a UV condition. The LTC2937 will recognize the low voltage and signal a SUPERVISOR fault.

- 1) Start with the system sequenced-up. The LDOs are on.
- 2) Press and release the FAULT pushbutton. This shorts EN4 to GND, disabling the 1.8V LDO.
- 3) Observe the fault response:

All ENn pins pull low immediately. All ENn LEDs turn off.

All of the LDO regulated supplies turn off immediately. All CHn LEDs turn off.

The LTC2937 is configured to automatically re-try after the fault, so it will attempt to sequence-up the supplies. Since the fault was momentary, the re-sequence will succeed.

Pin FAULTB will assert low until the fault retry interval is complete and the re-sequencing begins. The FAULT LED will illuminate during this interval.

Pin RSTB will assert low until the LDOs come-up after re-sequencing. The RST LED will illuminate during this interval.

Pin ALERTB will assert low. The ALERT LED will illuminate. The alert state will remain until an alert response or a read from the CLEAR\_ALERTB (0x28) comes from the I<sup>2</sup>C bus. Only a bus operation can release the ALERTB pin.

## QUICK START PROCEDURE (WITHOUT SOFTWARE)

The LTC2937 monitors each channel for individually-programmed overvoltage and undervoltage thresholds. The voltage monitoring is active while the supplies are up or sequencing-up.

The LTC2937 is configured to re-try after the fault; it will attempt to sequence-up again. There is a rich suite of fault response capabilities in the part, including turning off and staying off, turning-off then re-sequencing, continuing operation without turning off, or entering a debug mode. More details are available later in this manual, and in the LTC2937 data sheet.

The FAULT indicators are self-clearing upon a re-sequence initiation. The only fault indications after a successful re-sequence-up are the asserted ALERTB pin, and the EEPROM record of the first fault condition after the most recent power-up that produced the fault. The ALERTB pin will remain asserted low until the ALERT condition is cleared with an I<sup>2</sup>C bus operation.

### Sequence Fault

A SEQUENCE fault is caused by supplies failing to meet programmed voltage thresholds within programmed time allowances during sequencing (for example, not ramping fast enough).

Create this type of fault on the DC2313A board by pulling and holding down one of the ENn turrets to GND while sequencing-up the supplies. This will hold down the associated LDO and create a permanent UV condition. The LTC2937 will recognize the unresponsive LDO and signal a fault.

- 1) Start with the system sequenced-down. The LDOs are off.
- 2) Short turret EN4 to GND and hold it there (press and hold the FAULT pushbutton).
- 3) Press the “SEQUENCE UP/DOWN” button to initiate a sequence-up operation.
  - EN1 - EN3 go high in sequence
  - CH1 - CH3 start in response to EN1-EN3
  - CH4 fails to start. LEDs EN4-6, CH4-6 remain off.
- 4) Observe the repeated fault retry response (see the table)

Pins EN1 - EN3 pull low immediately. All illuminated ENn LEDs turn off.

All of the LDO regulated supplies turn off. Illuminated CHn LEDs turn off.

The LTC2937 is configured to automatically re-try after a delay, so it will attempt to sequence-up the supplies after detecting the fault. Since the LDO is shorted, the fault persists, and re-sequencing will repeatedly fail. The cycle will repeat until the fault is removed (by releasing the FAULT pushbutton).

Pin FAULTB will assert low for the retry interval, until the re-sequence begins. LED FAULT will illuminate during the interval.

The FAULTB pin clears as soon as a re-sequence begins. The FAULT LED illuminates briefly, then goes off.

Pin RSTB will remain low. The RST LED will remain illuminated because not all of the supplies ever come up.

Pin ALERTB will assert low. The ALERT LED will illuminate. The alert state will persist until an alert response or a read from the CLEAR\_ALERTB (0x28) comes from the I<sup>2</sup>C bus. Only a bus operation can release the ALERTB pin.

- 5) Remove the EN4 fault by releasing the FAULT pushbutton.
- 6) Observe that the part completes the re-sequence autonomously, and the fault response clears automatically. The RST LED goes off after all supplies are up.

Each channel has an independently-configurable time limit for starting-up and rising above its UV threshold voltage. Each channel also has independently-programmable sequence-down time parameters.

The LTC2937 is configured by default in the FAULT\_RESPONSE (0x23) register to automatically re-sequence-up after all of the supplies are disabled and the voltages fall below their discharge thresholds. While the EN4 pin is held low, the fault persists, and the LTC2937 is programmed to automatically try to re-sequence the supplies forever, so the behavior will repeat indefinitely.

## QUICK START PROCEDURE (WITHOUT SOFTWARE)

After the fault goes away the next automatic re-sequence will succeed. The FAULTB pin will de-assert. The FAULT LED will go off. Initiation of the next sequence-up operation will clear the fault information in registers. The ALERTB pin will remain asserted low until the ALERT condition is cleared with an I<sup>2</sup>C bus operation.

### Margining The Supplies

Margin testing stresses the system by moving voltages beyond their normal OV and UV limits without generating a fault. The MARGIN switch on the DC2313A board pulls down the MARGB pin on the LTC2937, causing it to ignore OV and UV faults while in the sequenced-up state. Note that the LTC2937 does not control the voltages. Margining the supplies involves pulling the regulators to out-of-spec voltages, which is done outside of the LTC2937. The LDO regulators on the DC2313A board do not change voltage, but we can demonstrate MARGIN capability while disabling one of the LDOs.

- 1) Begin with the system sequenced-down (all supplies OFF)

While the supplies are down, the RST LED is illuminated.

- 2) Switch SW3 to the MARGIN position (MARGIN active).

Observe the RST LED goes off, indicating that the LTC2937 is ignoring the UV conditions.

- 3) Press the “SEQUENCE UP/DOWN” pushbutton to sequence-up normally.

The PB\_EN and GLOBAL\_ON LEDs will illuminate.

The ENn LEDs will illuminate in sequence: 1-6.

The CHn LEDs will illuminate in sequence with the ENn LEDs.

The RST LED will remain off because the MARGIN function is active.

The FAULT LED will remain off.

The ALERT LED will remain off.

No voltage (UV and OV) limits are measured. The default timing parameters should not detect faults.

- 4) While the MARGIN switch is active, short the EN4 turret to GND by pressing the FAULT pushbutton.

The corresponding CH4 will go down and the LED will go off.

No faults are detected due to the MARGIN function.

Note that the MARGIN function is only useful while the supplies are sequenced-up, not while they are in the process of sequencing. Holding the MARGB pin asserted low does not mask SEQUENCE (timing) faults during sequencing-up operations. If a supply fails to meet its programmed sequence-up voltage/timing requirements then the normal fault response prevails, regardless of MARGB state.

## SOFTWARE CONTROL WITH LTPowerPLAY

LTpowerPlay is a convenient PC software GUI that gives complete access to the registers of the LTC2937, and many other Linear Technology Power System Management parts. Use it in off-line mode to build a system configuration file, even with no hardware plugged-in, and use it with hardware connected to configure and debug your application. LTpowerPlay communicates using the I<sup>2</sup>C bus in the demo system (covered in this manual), or in your real-world product environment. It provides unprecedented control over the Linear Technology chips on the I<sup>2</sup>C bus. Use it

during board bring-up to tune and optimize the power system parameters. Use it during system debug to view critical system information and troubleshoot board design or manufacturing issues. LTpowerPlay includes extensive help and documentation under the Help menu. On-line help includes quick-start videos and tutorials, and detailed technical documentation from the Linear Technology web site. Getting started with LTpowerPlay is easy. Simply download and install the PC software from here:

<http://www.linear.com/ltpowerplay>

## SOFTWARE CONTROL WITH LTPOWERPLAY

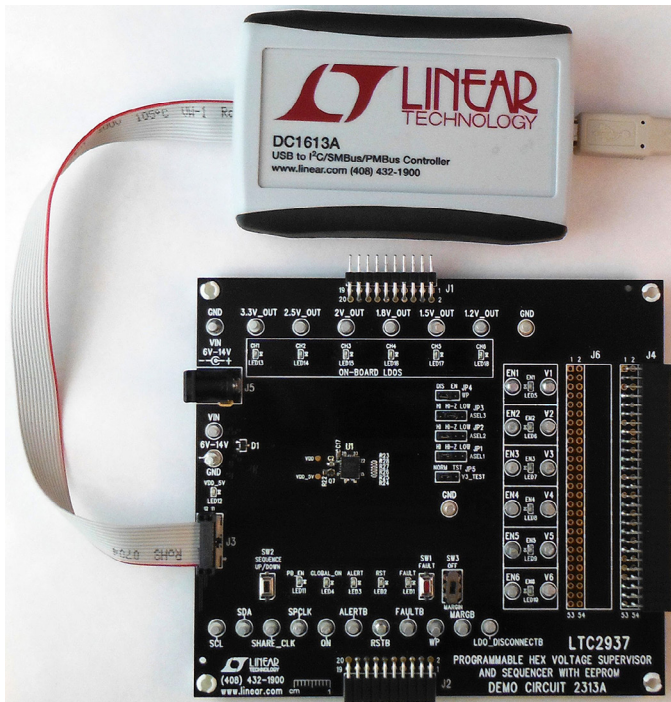

Figure 4. DC2313A Demo Board Connected to DC1613A I<sup>2</sup>C-to-USB Converter

The DC1613 USB-to-I<sup>2</sup>C adapter interfaces the PC running LTpowerPlay to the DC2313A board (or any board with an I<sup>2</sup>C bus). Connect the DC1613 adapter to the PC through a USB cable, and connect it to the DC2313A board through the ribbon cable to connector J3.

Launch the LTpowerPlay GUI on the PC. The software identifies the DC1613 controller, then the DC2313A board, and begins communicating through the I<sup>2</sup>C bus with the LTC2937. Once this communication has been established, the GUI displays its main window (Figure 5).

The LTpowerPlay GUI divides information into separate panes in the window. On the left is the System Tree pane, displaying a list of all Linear Technology devices identified on the I<sup>2</sup>C bus. For a single LTC2937 device, the tree is small, but if other supported devices are present on the I<sup>2</sup>C bus, LTpowerPlay will add them. Click on a device in this list to selectively access it. Information in other panes pertains to the selected device.

### LTpowerPlay System Tree

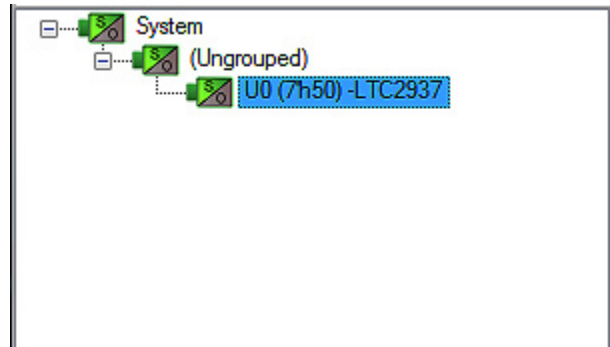

To the right of the system tree is the Configuration Register pane, displaying all of the configuration registers available on the selected device. This view shows all of the writable user-configurable RAM registers, and the GUI offers clickable buttons and fields to edit the information in these registers.

### LTpowerPlay Configuration Registers

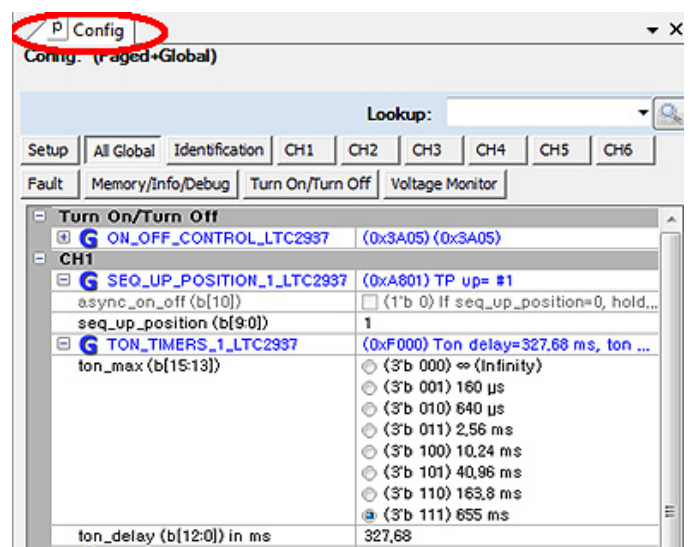

Update register contents by clicking or typing to change the desired registers, then selecting the “Write All” button in the top toolbar. LTpowerPlay writes changes to the updated registers.





# SOFTWARE CONTROL WITH LTPOWERPLAY

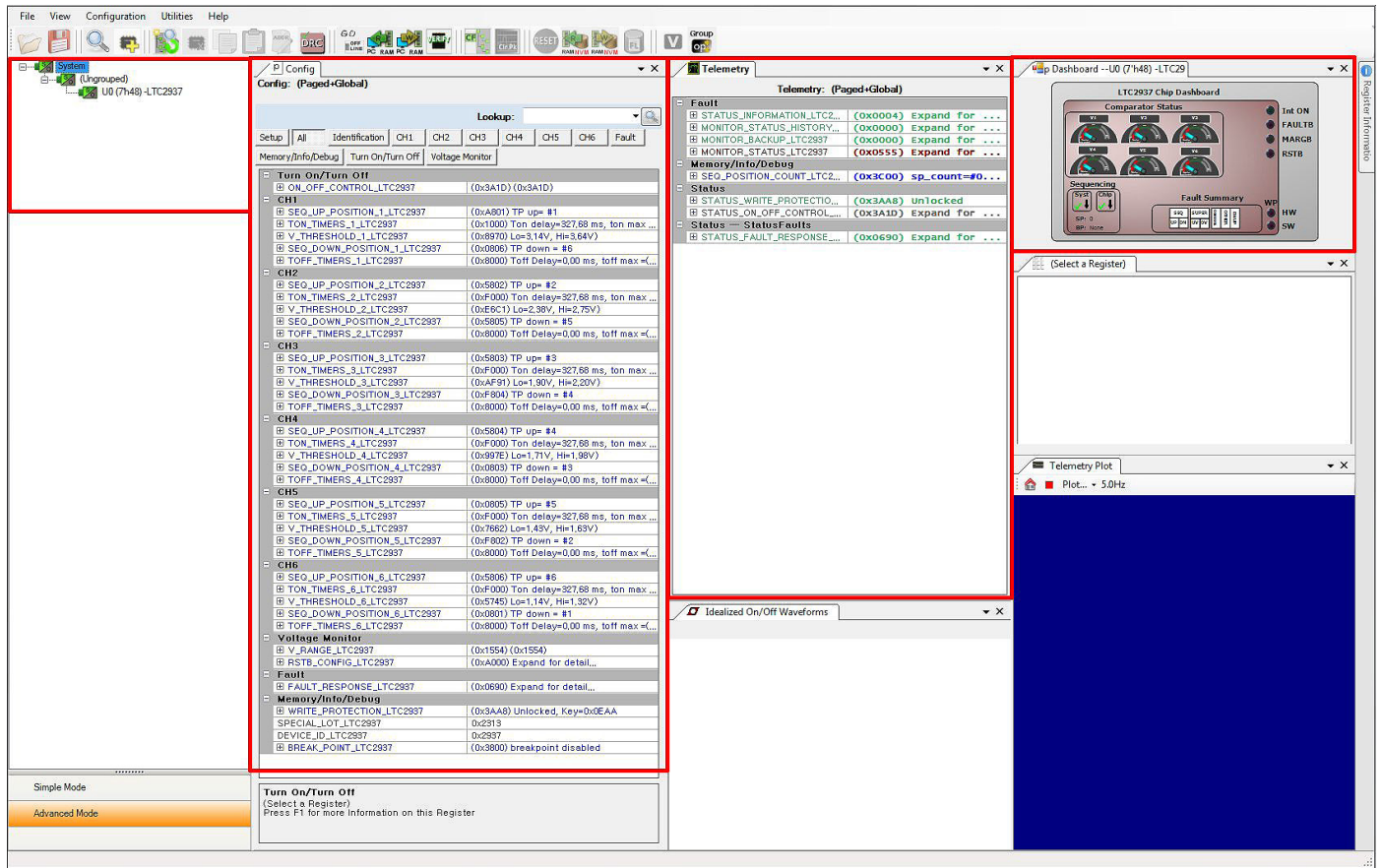
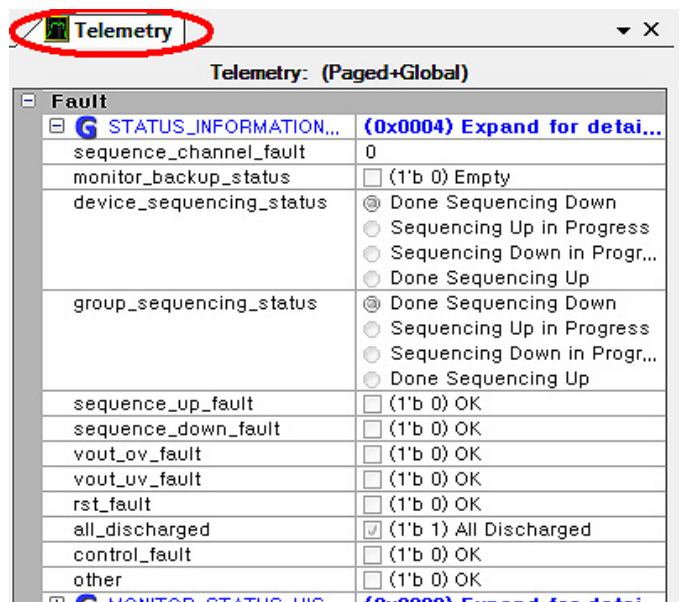

Figure 5. LTpowerPlay GUI Window

Note that programming the registers in the LTC2937 should generally be done while the part is in the sequenced-down state. Most of the registers have immediate control over their respective chip functions, and changing them while the part is sequenced-up will have unpredictable and adverse effects. It is recommended to sequence-down before updating configuration register settings. LTpowerPlay implements limits to writing some registers, based upon the device state, and will pop-up warnings when necessary.

Right of center in LTpowerPlay is the Telemetry pane, displaying read-only information contained in the status registers of the selected part. The GUI periodically polls the I<sup>2</sup>C bus and updates the Telemetry contents in real time, along with a user-friendly interpretation of the bits.

## LTpowerPlay Telemetry



## SOFTWARE CONTROL WITH LTPOWERPLAY

In the upper right corner of LTpowerPlay is the Chip Dashboard pane, displaying a graphical representation of the part status in a friendly, easy-to-understand format. The live channel voltage comparator OV and UV states are shown in the “Comparator Status”. The sequencing state is represented in the “Sequencing” block. Fault status is summarized in the “Fault Summary” block. Other status bits are represented by light-up red-yellow-green indicators on the right-hand side. These intuitive indicators give the part status at-a-glance.

LTPowerPlay Chip Dashboard

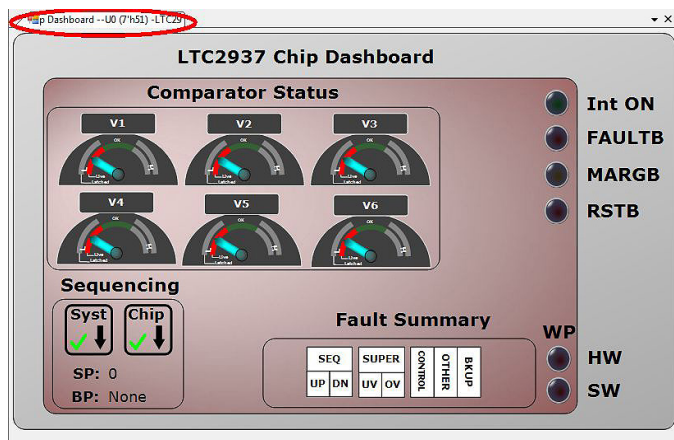

## LTC2937 REGISTERS

LTC2937 RAM and Non-Volatile Memory

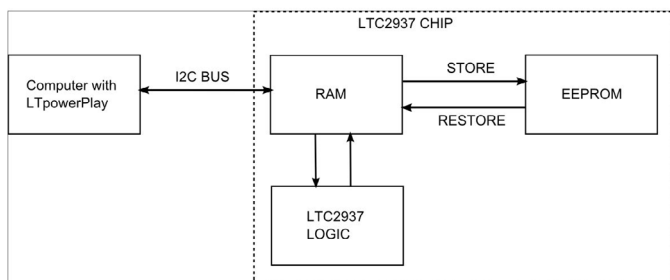

The LTC2937 is highly configurable through its register set. Refer to the LTC2937 data sheet for a complete discussion of the registers and functions available. Get immediate access to detailed help for the selected register in LTpowerPlay by pressing the F1 key on your keyboard.

The LTC2937 features an EEPROM non-volatile memory that holds device configuration information and a snapshot of past fault information. When the part receives power it executes a power-on reset, and restores the contents of the EEPROM to its operating RAM memory. Following this power-on restore, operating RAM memory can be modified with I<sup>2</sup>C bus commands that modify the part behavior. This modified state can be stored to the EEPROM with a STORE (0x2C) command, making it available as the future default power-up state. The STORE command will copy the entire contents of the configuration RAM into EEPROM. The data sheet recommends storing EEPROM contents only while the part is sequenced-down.

In addition to power-on reset, the EEPROM contents can also be retrieved to RAM operating memory with a RESTORE (0x2D) command. RESTORE wipes-out the content of the RAM and replaces it with the EEPROM contents. Only perform a RESTORE when the LTC2937 is in the sequenced-down state, as the RAM operating memory immediately affects the chip, and changing its contents while sequenced-up can result in unpredictable behavior.

Both RAM and EEPROM respect write-protection on the LTC2937. Both the WP pin and the WRITE\_PROTECTION (0x00) register provide write protection. Configure both the pin and the register to allow writing to memory. To enable writing, pull the hardware WP pin to ground by setting jumper JP4 to DIS. Write the command 0x00 with bit 0 = 0, and the same key that is in WRITE\_PROTECTION[15:2]. The demo board default for the WRITE\_PROTECTION register and the WP pin allow writing to memory.

The following exercises approach the registers in a task-oriented manner, demonstrating register functions through examples.

### Default Configuration

If the LTC2937 EEPROM contains non-default contents, then returning it to the demo-board default settings can be accomplished with the LTpowerPlay “Demo” menu selection.

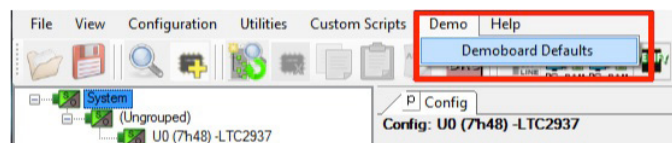

## SOFTWARE CONTROL WITH LTPOWERPLAY

Clicking the “Demoboard Defaults” menu item stores default register settings in RAM, issues a CLEAR command, then executes a STORE command to store the RAM contents into EEPROM. This places the LTC2937 back into its default setting for the demo board. Note that this procedure only works if the ASEL jumpers are configured in their default settings:

- ASEL1 = HI
- ASEL2 = HI
- ASEL3 = HI

### ON/OFF CONTROL

The LTC2937 provides control over all of its functions through the register interface. This includes ON/OFF control. The part can respond to the hardware ON/OFF pin, or to a register ON/OFF bit, or to both. In this exercise, we will sequence the system up and down using the I<sup>2</sup>C bus command, ignoring the hardware ON/OFF pin. To program the part to turn on and off through the I<sup>2</sup>C bus:

- 1) Start with the part sequenced-down (PB\_EN LED is off, LDOs are off).
- 2) Program register ON\_OFF\_CONTROL (0x02) by clicking the checkboxes for each bit to sequence-up via the I<sup>2</sup>C bus:
  - b[2] = 0 (ignore the ON input pin)
  - b[3] = 1 (honor the software ON/OFF bit)
  - b[4] = 1 (software ON/OFF state is ON)

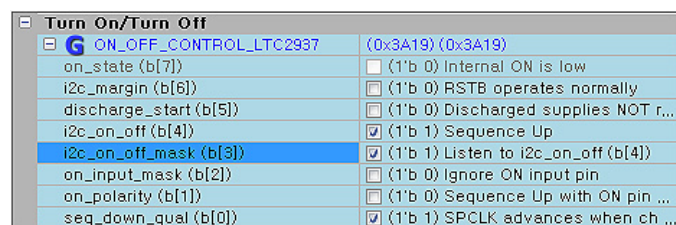

- 3) Send the register updates from LTpowerPlay to the LTC2937 by pressing the Write All Button:



- 4) The supplies sequence-up normally

The ENn LEDs will illuminate in sequence: 1-6.

The CHn LEDs will illuminate in sequence with the ENn LEDs.

The RST LED will turn off after the last CHn LED illuminates.

The LTC2937 Chip Dashboard in LTpowerPlay tracks the internal register status in real time as it sequences-up.

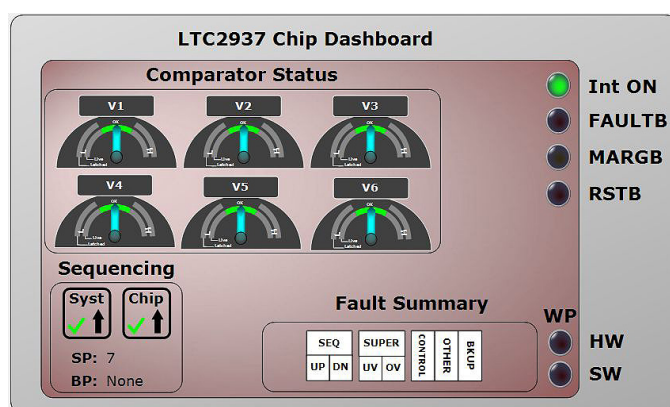

In the LTC2937 internal registers:

The ON\_OFF\_CONTROL[7] bit becomes set, indicating that the part is commanded to sequence-up.

The STATUS\_INFORMATION[11:10] bits cycle through the sequence-up states:

- 00b : sequence-down complete
- 01b : sequence-up in-progress
- 11b : sequence-up complete

The SEQ\_POSITION\_COUNT[9:0] bits count through the sequence-up states (1 – 7).

The FAULT LED will remain off.

The ALERT LED will remain off.

The PB\_EN and GLOBAL\_ON LEDs will remain off. The ON pin is low.

The default voltage (UV and OV) limits and timing parameters should not detect faults.

## SOFTWARE CONTROL WITH LTPOWERPLAY

5) Setting register bit ON\_OFF\_CONTROL[4] = 0 commands the part to sequence-down. All sequence timing and voltage limits apply. Click the i2c\_on\_off (b[4]) checkbox and hit 'F12' on the keyboard to update the register in the LTC2937.

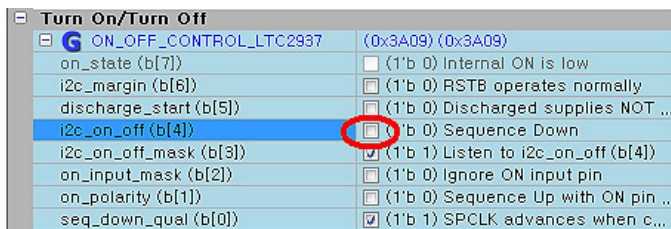

The ENn LEDs will turn off in sequence: 6-1.

The CHn LEDs will turn off in sequence with the ENn LEDs.

The RST LED will illuminate after the first CH6 LED turns off.

The ON\_OFF\_CONTROL[7] bit becomes low, indicating that the part is commanded to sequence-down.

The STATUS\_INFORMATION[11:10] bits cycle through the sequence-down states:

11b : sequence-up complete

10b : sequence-down in-progress

00b : sequence-down complete

The SEQ\_POSITION\_COUNT[9:0] bits count through the sequence-down states (1 – 7).

The FAULT LED will remain off.

The ALERT LED will remain off.

The PB\_EN and GLOBAL\_ON LEDs will remain off. The ON pin is low.

The default voltage (UV and OV) limits and timing parameters should not detect faults.

This procedure is equivalent to pressing the “SEQUENCE UP/DOWN” pushbutton on the board to command a sequence-up and sequence-down.

Restore the EEPROM default register settings by executing a RESTORE (0x2D) command. In LTpowerPlay this command is issued by pressing the RESTORE button, followed by the read RAM registers button:



### SUPPLY SEQUENCE ORDER

The LTC2937 provides complete sequence order and timing control over enabling and disabling the supplies. Sequenced supplies can be commanded to come-up in any order, and to go down in any (different) order. The LTC2937 provides up to 1023 ordered sequence positions in which events can be scheduled during sequence-up and sequence-down. Each supply has its own SEQ\_UP\_POSITION\_n register (0x16 – 0x1B) and SEQ\_DOWN\_POSITION\_n register (0x1C – 0x21). In the demo-board default settings, the supplies sequence-up in the order 1-6, and sequence-down in the order 6-1. We can change this ordering by writing to the registers:

1) Begin with the LTC2937 in the sequenced-down state (all supplies off).

2) Write each of the 6 SEQ\_UP\_POSITION\_n registers to change their sequence positions:

SEQ\_UP\_POSITION\_1 = 0x0005 : place channel 1 in sequence position 5

Do this by clicking on the “SEQ\_UP\_POSITION\_1\_LTC2937” text, and typing 0x0805 then ENTER. This updates the register value in the GUI.

You may also click on “seq\_up\_position (b[9:0])” and typing “5” ENTER. Notice that the hex value updates as a result.

## SOFTWARE CONTROL WITH LTPOWERPLAY

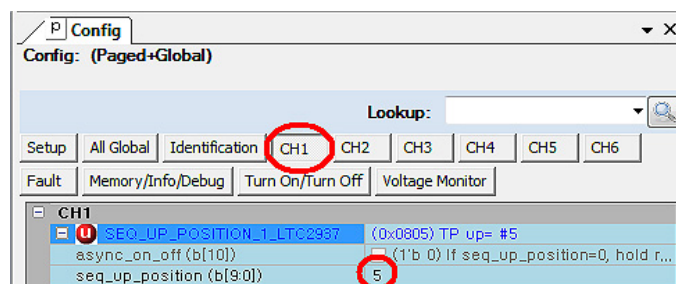

After modifying a register hit F12 on the keyboard to update that register in the LTC2937 RAM.

Continue with the other channels:

SEQ\_UP\_POSITION\_2 = 0x0007 : place channel 2 in sequence position 7

SEQ\_UP\_POSITION\_3 = 0x0003 : place channel 3 in sequence position 3

SEQ\_UP\_POSITION\_4 = 0x0001 : place channel 4 in sequence position 1

SEQ\_UP\_POSITION\_5 = 0x0002 : place channel 5 in sequence position 2

SEQ\_UP\_POSITION\_6 = 0x0004 : place channel 6 in sequence position 4

3) Write each of the 6 SEQUENCE\_DOWN\_POSITION\_n registers to change their sequence positions:

SEQ\_DOWN\_POSITION\_1 = 0x0001 : place channel 1 in sequence position 1

SEQ\_DOWN\_POSITION\_2 = 0x0001 : place channel 2 in sequence position 1

SEQ\_DOWN\_POSITION\_3 = 0x0007 : place channel 3 in sequence position 7

SEQ\_DOWN\_POSITION\_4 = 0x0003 : place channel 4 in sequence position 3

SEQ\_DOWN\_POSITION\_5 = 0x03FF : place channel 5 in sequence position 1023

SEQ\_DOWN\_POSITION\_6 = 0x0004 : place channel 6 in sequence position 4

4) If you have not already written the GUI configuration to RAM (using F12), then update all registers with the Write All button



5) Initiate a sequence-up by writing ON\_OFF\_CONTROL[4:2] = 110.

Remember that we are programmed to ignore the SEQUENCE UP/DOWN pushbutton.

6) Observe the modified sequence-up order as the supplies come up.

The ON\_OFF\_CONTROL[7] bit becomes set

The STATUS\_INFORMATION[11:10] bits cycle through the sequence-up states

The SEQ\_POSITION\_COUNT[9:0] bits count through the sequence-up states (1-8).

7) Initiate a sequence-down by writing ON\_OFF\_CONTROL[4:2] = 010.

The SEQ\_POSITION\_COUNT[9:0] bits count through the sequence-down states (1-1023-0).

Notice that channel 5 is in the last sequence-down position (1023). During sequence-down operation the SEQUENCE POSITION COUNT will count up to 1023 before de-activating EN5, then roll-over to count 0 before stopping.

Restore the EEPROM default register settings by executing a RESTORE (0x2D) command. In LTpowerPlay this command is issued by pressing the RESTORE button, followed by the read RAM registers button:



## SOFTWARE CONTROL WITH LTPOWERPLAY

Each supply can occupy any one of the 1023 available sequence positions. Multiple supplies can occupy the same sequence position – for example, they could all occupy sequence position 3. Unused sequence positions take a minimal amount of time (80µs) to complete, but do not trigger any enable or disable events. The part continues counting until the last used sequence position, plus one.

Within each sequence position, additional flexibility is available for enable and disable timing of each supply using the `ton_delay` and `toff_delay` settings. Each supply can delay up to 655ms from the start of its sequence position before enabling (`TON_TIMERS[12:0]`) or disabling (`TOFF_TIMERS[12:0]`). This provides deterministic timing relationships between supplies within a sequence position. The sequence position clock waits for all scheduled supplies in that position. These behaviors are best observed with a scope, since the time resolution is microseconds – much faster than the eye can observe the LEDs on the board sequencing.

Further flexibility is available if multiple LTC2937s sequence many supplies. The LTC2937 parts communicate through the `SPCLK` and `SHARE_CLK` signals so that they maintain a common sequence count and timebase, and a large number of supplies can be sequenced in an autonomously coordinated, deterministic manner. Use the `SEQ_UP_POSITION`, `SEQ_DOWN_POSITION`, `ton_delay`, and `toff_delay` registers to freely interleave supplies across multiple LTC2937s.

### FAULT RESPONSE

To this point, the demonstrations have shown the LTC2937 responding to faults by autonomously re-starting the supplies without software. This important behavior is only one of the possible choices, however. The LTC2937 provides a rich and configurable set of fault response capabilities allowing either an autonomous recovery, an I<sup>2</sup>C bus mediated response, or a completely interactive software debugging experience.

The LTC2937 data sheet details all of the fault-response registers, and the various programming options for handling faults, and debugging behaviors. Below are several examples.

### Re-Try Count

In the DC2313 demo board the LTC2937 is configured to re-try an unlimited number of times when it detects a SUPERVISOR or SEQUENCE fault. It can instead be configured to respond in a limited way to a fault, and give-up if the problem persists. The number of re-try attempts can be set with the `FAULT_RESPONSE[2:0]` register bits (`retry_number`). Any number of attempts can be specified, from 0 to 6, or unlimited. The part will respond to a SUPERVISOR or SEQUENCE fault by turning-off the supplies, then trying to sequence-up. It will register the number of attempts in the `FAULT_RESPONSE[13:11]` bits, and stay off after failing the specified number of times.

### Fault Debug

In this exercise set the fault response to zero automatic re-tries, which will enable debugging. Create a fault on the DC2313A board with the `FAULT` pushbutton.

- 1) Start with the system sequenced-down. The LDOs are off.
- 2) Set `FAULT_RESPONSE[2:0] = 0x0`. This sets zero re-try attempts after a fault.

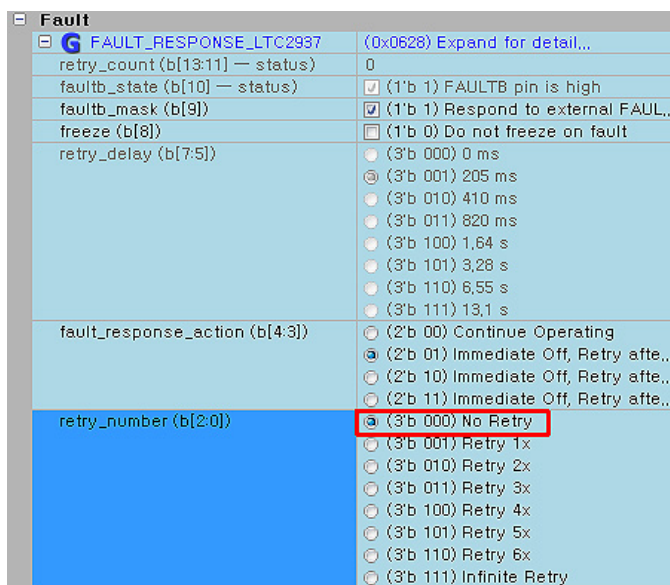

## SOFTWARE CONTROL WITH LTPOWERPLAY

- 3) Press the “SEQUENCE UP/DOWN” pushbutton and wait for sequence-up to complete.
- 4) Press and release the FAULT pushbutton, momentarily shorting EN4 to GND and bringing down the 1.8V LDO. The LTC2937 immediately recognizes the low V4 voltage.
- 5) Observe the fault response

All ENn pins pull low immediately. All ENn LEDs turn off.

All of the LDO regulated supplies turn off immediately. All Chn LEDs turn off.

The fault response setting allows no re-try attempts, so the supplies remain off.

Pin FAULTB will assert and remain low. LED FAULT will illuminate.

Pin RSTB will assert low. LED RST will illuminate.

Pin ALERTB will assert low. LED ALERT will illuminate. The alert state will remain until an alert response or a read from the CLEAR\_ALERTB (0x28) comes from the I<sup>2</sup>C bus.

Register MONITOR\_STATUS (0x30) will briefly report the real time UV comparator assertion until the fault goes away when the FAULT button is released.

Register MONITOR\_STATUS\_HISTORY (0x26) will report the latched SUPERVISOR UV fault condition. This information remains because the LTC2937 does not re-sequence.

Register STATUS\_INFORMATION (0x29) will report the latched SUPERVISOR UV fault condition.

Register MONITOR\_BACKUP in EEPROM will mirror MONITOR\_STATUS\_HISTORY register contents, but only if this is the first fault since power applied. If this is not the first fault, MONITOR\_BACKUP will contain older fault information. Execute a RESTORE command to view the MONITOR\_BACKUP register contents.

The LTC2937 does not attempt to recover from the fault. Instead, it turns-off all of the supplies and retains all of its status register contents. This enables a thorough post-fault examination of status registers in the state they were when the fault occurred.

The LTpowerPlay Chip Dashboard shows the summary of fault information. This conveniently indicates that the part has detected a SUPERVISOR UV fault, and that fault information is stored in the EEPROM MONITOR\_BACKUP register.

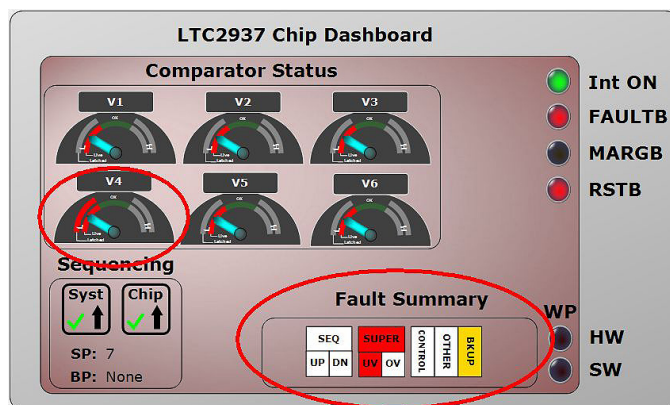

Note that the V4 dial has a double red arc, indicating that the V4 channel caused the UV fault that brought-down the system.

Notice that ALL status information is retained in the state it was in when the fault occurred. This includes the sequencer state (SP=7, Syst=UP, Chip=UP). The STATUS\_INFORMATION[11:10] and STATUS\_INFORMATION[9:8] were in the “sequence-up complete” state when the fault occurred, so these states are retained. The state machine still thinks it is in the same state.

Register	Value	Details
STATUS_INFORMATION_LTC2937 (0x1F1C)	Expand for detail...	
sf_channel (b[15:13])	0	
mb_state (b[12])	(1b 1) MONITOR_BACKUP Written	
local_seq_status (b[11:10])	(2b 00) Sequence Down Complete (2b 01) Sequence Up in Progress (2b 10) Sequence Down in Progress (2b 11) Sequence Up Complete	
group_seq_status (b[9:8])	(2b 00) Sequence Down Complete (2b 01) Sequence Up in Progress (2b 10) Sequence Down in Progress (2b 11) Sequence Up Complete	
seq_up_fault (b[7])	(1b 0) OK	
seq_down_fault (b[6])	(1b 0) OK	
ov_fault (b[5])	(1b 0) OK	
uv_fault (b[4])	(1b 1) RESET Fault Caused by mapped UV condition	
reset_fault (b[3])	(1b 1) RESET fault occurred	
discharge (b[2])	(1b 1) All Sequenced voltages are below discharge...	
seq_control_fault (b[1])	(1b 0) OK	
other_fault (b[0])	(1b 0) OK	
MONITOR_STATUS_HISTORY_LTC2937 (0x1010)	Expand for detail...	
MONITOR_BACKUP_LTC2937 (0x2000)	Expand for detail...	
MONITOR_STATUS_LTC2937 (0x1555)	Expand for detail...	

## SOFTWARE CONTROL WITH LTPOWERPLAY

Status register contents are cleared when the LTC2937 begins a new sequence-up operation, so allowing automatic re-try after a fault eliminates the debug information that might exist in the registers.

The only fault information that will persist beyond a successful re-sequence initiation is in the EEPROM MONITOR\_BACKUP register, which stores the contents of the MONITOR\_STATUS\_HISTORY register when the first fault after power-up is detected.

The ALERTB pin will remain asserted low until the ALERT condition is cleared with an I<sup>2</sup>C bus (ARA) operation.

### Recovering from and Clearing Faults

The FAULTB pin and status registers respond to a fault condition, but can be cleared when the LTC2937 re-sequences the power supplies. Along with the status information registers, the FAULTB pin is cleared when the sequence starts. In the case where fault information and the FAULTB pin need to be cleared manually, the CLEAR (0x2E) command is available.

LTPowerPlay allows the user to issue the CLEAR command (0x2E) that clears the fault and status registers. Issue the CLEAR command by pressing the “CLEAR” button in the toolbar:



**Warning: avoid issuing a CLEAR command while the LTC2937 is in the sequenced-up state. The registers and state-machines that get cleared have an immediate effect on the part, and will cause the supplies to fault and re-sequence, which is usually an undesired behavior. Sequence-down before issuing a CLEAR command.**

If the LTC2937 is waiting, not re-trying, after a fault, turn it off (press the “SEQUENCE UP/DOWN” button to turn-off the PB\_EN and GLOBAL\_ON LEDs). The LTC2937 will retain state, but will be ready to sequence-up. Press the “SEQUENCE UP/DOWN” button again to sequence-up normally and clear the latched fault status and the FAULTB pin. The ALERT pin will remain asserted until cleared.

### Clearing the ALERTB Pin

The ALERTB pin conforms to the SMBus protocol for the SMBALERT fault response. It is designed to act as an interrupt for a controller on the I<sup>2</sup>C bus. The LTC2937 ALERTB pin asserts when a fault event occurs, and it can only be cleared by an appropriate bus response from the controller.

When the ALERTB pin asserts, a controller may either execute an alert response through the Alert Response Address (0x0C), which is defined as the ARA in the SMBus protocol, or the controller may read from register CLEAR\_ALERTB (0x28) to immediately de-activate the ALERTB pin.

LTPowerPlay will include the CLEAR\_ALERTB command when sending a CLEAR\_FAULTS command if the behavior is selected in the Preferences menu. Pull-down View→ Preferences..., then select “Issue CLEAR\_ALERTB on CLEAR” = TRUE. When you click the CLEAR\_FAULTS button in the GUI it will also clear ALERTB.

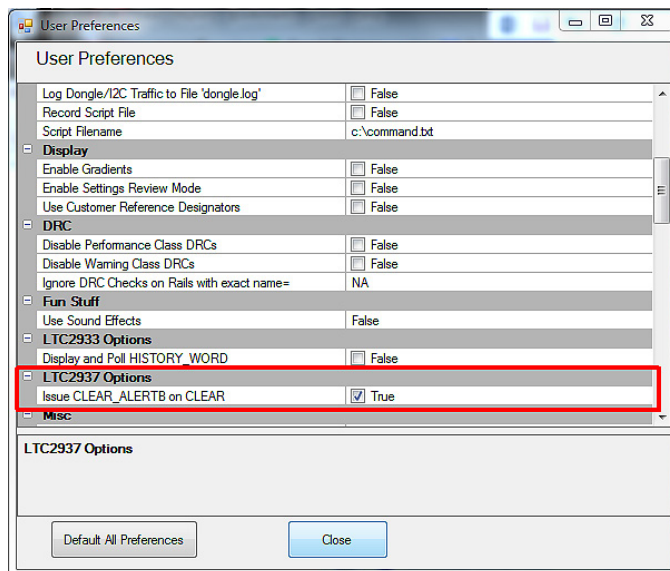



## SOFTWARE CONTROL WITH LTPOWERPLAY

### EEPROM Fault Backup

The LTC2937 stores information about the “first” fault that it detects into the EEPROM MONITOR\_BACKUP register. The information is a copy of the MONITOR\_STATUS\_HISTORY register at the time of the fault. Subsequent power-cycling has no effect on this stored information, which can be read with the MONITOR\_BACKUP command (0x2F) after a RESTORE, or a after a power-cycle. This debug information survives subsequent sequencing operations, and power cycling. Only the first fault information is stored in EEPROM. The indicator bit, STATUS\_INFORMATION[12] holds a persistent 1 if the MONITOR\_BACKUP register contains a fault record.

Re-arm the MONITOR\_BACKUP register to accept a new “first” fault by clearing it according to this recipe:

- 1) Begin in the sequenced-down state. The supplies are off. The register STATUS\_INFORMATION[11:8] = 0x0.
- 2) Issue a CLEAR command (0x2E) by pressing the “CF” button in LTpowerPlay. This clears any fault information, including MONITOR\_STATUS\_HISTORY.

- 4) Issue a RESTORE command (0x2D). This restores the clean MONITOR\_BACKUP register contents from EEPROM. It clears the STATUS\_INFORMATION[12] indicator bit. It also restores all configuration registers from EEPROM.



Note that it is important to perform the CLEAR and RESTORE operations (in that order) while the part is finished sequencing-down. The internal sequencing state machine receives a reset when the CLEAR command is issued. If the LTC2937 is sequenced-up, or in the process of sequencing, this reset will generate a fault, possibly turn off the supplies, and re-sequence-up.

Also be aware that the STORE command affects the entire EEPROM, not only the MONITOR\_STATUS\_HISTORY word. This means that any changes that have been made to the RAM configuration registers will be stored in EEPROM. Also, if there is newer fault information in RAM than in the first fault MONITOR\_BACKUP register, it will be stored into EEPROM with a STORE command.



- 3) Issue a STORE command (0x2C). This stores the clean MONITOR\_STATUS\_HISTORY register contents to EEPROM. It also stores all configuration registers to EEPROM.



## DC2313A BOARD DESCRIPTION

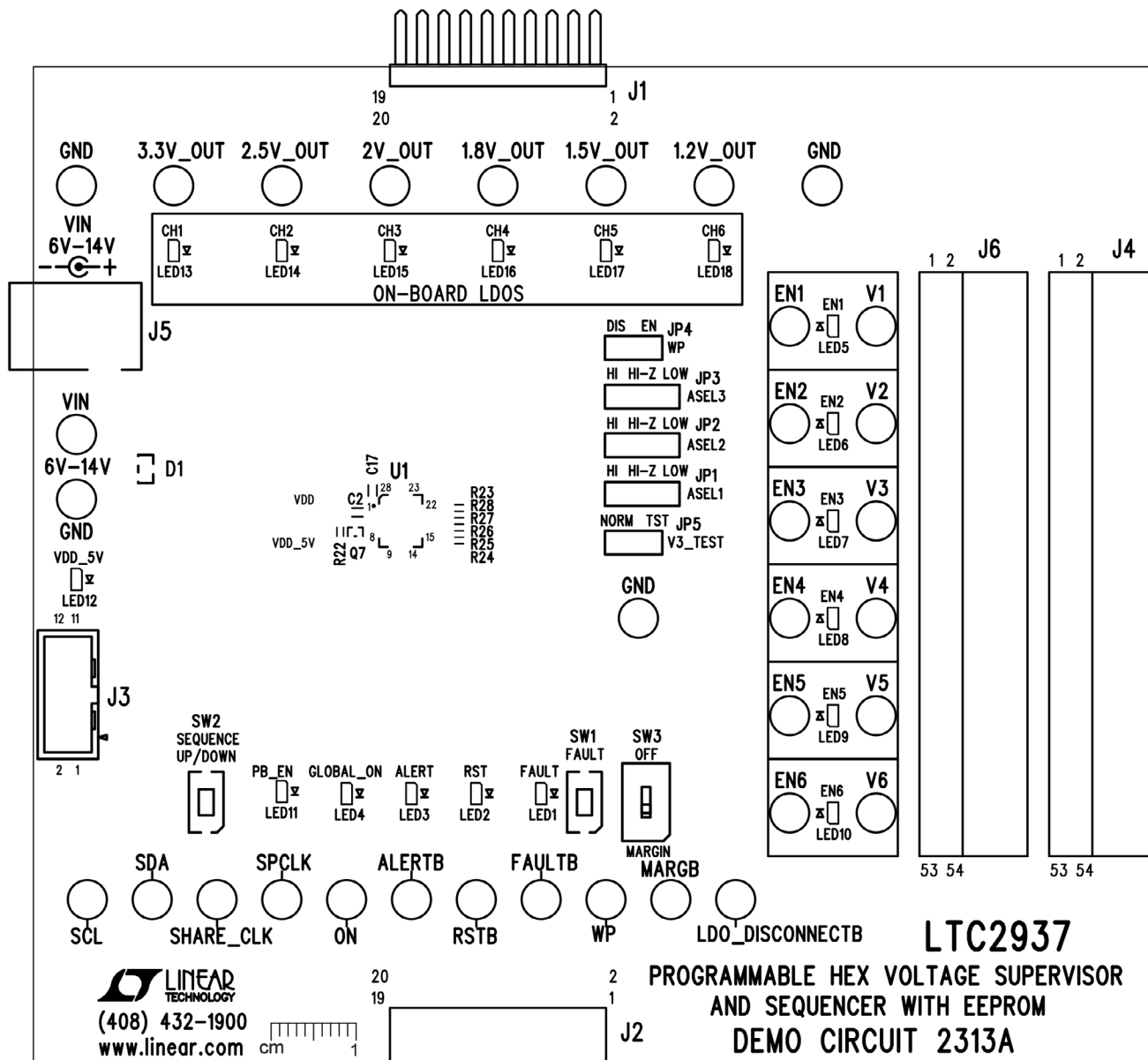

Figure 6. DC2313A Demo Board Layout

## PARTS LIST

ITEM	QTY	REFERENCE	PART DESCRIPTION	MANUFACTURER/PART NUMBER
<b>Required Circuit Components</b>				
1	4	C1, C7, C10, C17	CAP., 0.1 $\mu$ F, X5R, 16V, 10%, 0603	MURATA, GRM188R61C104KA01D
2	7	C2, C11-C16	CAP., 2.2 $\mu$ F, X5R, 10V, 10%, 0603	MURATA, GRM188R61A225KE34D
3	2	C3, C4	CAP., 0.01 $\mu$ F, X7R, 10V, 10%, 0603	AVX, 0603ZC103KAT2A
4	2	C5, C9	CAP., 10 $\mu$ F, X5R, 16V, 10%, 0805	MURATA, GRM21BR61C106KE15L
5	1	C6	CAP., 22 $\mu$ F, X5R, 25V, 20%, 0805	MURATA, GRM21BR61E226ME44K
6	1	C8	CAP., 1 $\mu$ F, X5R, 16V, 10%, 0603	MURATA, GRM188R61C105KA93D
7	1	D1	DIODE, Schottky, SOT23	VISHAY, BAS70-05-E3-08
8	34	E1-E34	TEST POINT, TURRET, .094" MTG. HOLE	MILL-MAX, 2501-2-00-80-00-00-07-0
9	3	JP1, JP2, JP3	CONN., HEADER, 1 $\times$ 4, 2mm	SULLINS, NRPN041PAEN-RC
10	2	JP4, JP5	CONN., HEADER, 1 $\times$ 3, 2mm	SULLINS, NRPN031PAEN-RC
11	1	J1	CONN., HEADER, 2 $\times$ 10, .100", R/A	MILL-MAX, 802-40-020-20-001000
12	1	J2	CONN., SOCKET, 2 $\times$ 10, .100", R/A	MILL-MAX, 803-93-020-20-001000
13	1	J3	CONN., HEADER, 2 $\times$ 6, 2mm, STR DL PCB	FCI, 98414-G06-12ULF
14	1	J4	CONN., SOCKET, 2 $\times$ 27, .100", R/A	SULLINS, PPTC272LJBN-RC
15	1	J5	CONN., POWER JACK, 2.1mm	CUI INC., PJ-002AH
16	0	J6	CONN., SOCKET, 2 $\times$ 27, .100", R/A	OPT
17	2	LED1, LED3	LED, RED, 0603	PANASONIC, LNJ237W82RA
18	1	LED2	LED, AMBER, 0603	PANASONIC, LNJ426W83RA
19	15	LED4-LED18	LED, GREEN, 0603	PANASONIC, LNJ326W83RA
20	7	Q1-Q7	XSTR., MOSFET, N-CH, SOT523	DIODES INC., DMG1012T-7
21	6	Q8-Q13	XSTR., NPN, SOT23	FAIRCHILD, MMBT3904
22	19	R1-R4, R6, R8, R10, R12, R14, R16, R18, R23, R29, R39, R40, R45, R46, R53, R54	RES., 3.01k, 1/10W, 1%, 0402	VISHAY, CRCW04023K01FKED
23	20	R5, R7, R9, R11, R13, R15, R17, R19, R21, R22, R24-R26, R30, R59-R64	RES., 100k, 1/16W, 1%, 0402	VISHAY, CRCW0402100KFKED
24	1	R20	RES., 374k, 1/16W, 1%, 0402	VISHAY, CRCW0402374KFKED
25	11	R27, R28, R32, R37, R38, R41, R42, R47, R48, R55, R56	RES., 10k, 1/16W, 1%, 0402	VISHAY, CRCW040210K0FKED
26	1	R31	RES., 46.4k, 1/16W, 1%, 0402	VISHAY, CRCW040246K4FKED
27	1	R33	RES., 9.31k, 1/16W, 1%, 0402	VISHAY, CRCW04029K31FKED
28	1	R34	RES., 249, 1/16W, 1%, 0402	VISHAY, CRCW0402249RFKED
29	1	R35	RES., 1k, 1/16W, 1%, 0402	VISHAY, CRCW04021K00FKED
30	6	R43, R44, R50, R52, R57, R58	RES., 200k, 1/16W, 1%, 0402	VISHAY, CRCW0402200KFKED
31	1	R49	RES., 1.37M, 1/16W, 1%, 0402	VISHAY, CRCW04021M37FKED
32	1	R51	RES., 590k, 1/16W, 1%, 0402	VISHAY, CRCW0402590KFKED
33	1	SW1	SWITCH, Push Button, SW-PTS635-25	C&K Components, PTS635SK25SMTR LFS

# DEMO MANUAL DC2313A

## PARTS LIST

ITEM	QTY	REFERENCE	PART DESCRIPTION	MANUFACTURER/PART NUMBER
34	1	SW2	SWITCH, Push Button, SW-PTS635-25	C&K Components, PTS635SL25SMTR LFS
35	1	SW3	CONN, SUB MINIATURE SLIDE SWITCHES	C&K.,JS202011CQN
36	1	U1	I.C, LTC2937IUHE, QFN28UHE-5x6	LINEAR TECH., LTC2937IUHE
37	2	U2, U3	I.C., DUAL BUFFERS, TSOP-6	NXP, 74LVC2G07GV,125
38	1	U4	I.C., PUSH BUTTON, DFN8DDB-3x2	LINEAR TECH., LTC2954IDDB-2
39	1	U5	I.C., LINEAR REG - 5V, TSOT23-5	LINEAR TECH., LT1761ES5-5
40	1	U6	I.C., DIODE OR, MSE16	LINEAR TECH., LTC4415IMSE
41	3	U7, U8, U9	I.C ANALOG SWITCH, SO16	LINEAR TECH, LTC222CS
42	1	U10	I.C SERIAL EEPROM, TSSOP8	MICROCHIP, 24AA02-I /ST
43	1	U11	I.C, LINEAR REG., DFN6DC-2x2	LINEAR TECH., LT3008IDC-3.3
44	1	U12	I.C, LINEAR REG., DFN6DC-2x2	LINEAR TECH., LT3008IDC-2.5
45	1	U13	I.C, LINEAR REG., DFN6DC-2x2	LINEAR TECH., LT3008IDC
46	1	U14	I.C, LINEAR REG., DFN6DC-2x2	LINEAR TECH., LT3008IDC-1.8
47	1	U15	I.C, LINEAR REG., DFN6DC-2x2	LINEAR TECH., LT3008IDC-1.5
48	1	U16	I.C, LINEAR REG., DFN6DC-2x2	LINEAR TECH., LT3008IDC-1.2
49	5	SHUNTS ON JP1-JP5 PINS 1&2	SHUNT, .079" CENTER	SAMTEC, 2SN-BK-G
50	4	MH1-MH4	STANDOFF, SNAP ON, 1/4"	KEYSTONE, 8831

**SCHEMATIC DIAGRAM**

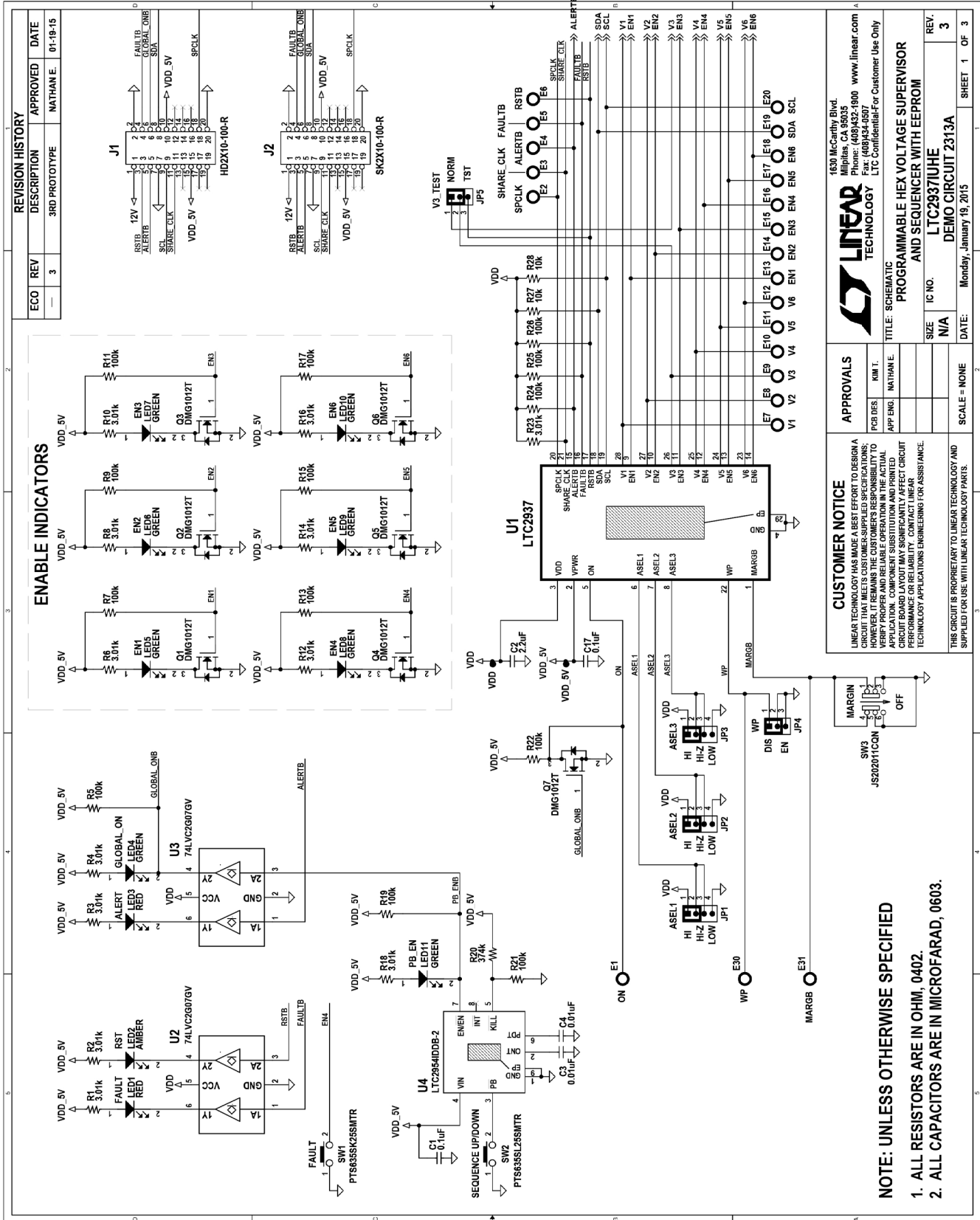

1630 McCarthy Blvd.  
Milpitas, CA 95055  
Phone: (408)432-1900 www.linear.com  
Fax: (408)434-9507  
LTC Confidential/For Customer Use Only

**LINEAR TECHNOLOGY**

TITLE: SCHEMATIC  
PROGRAMMABLE HEX VOLTAGE SUPERVISOR AND SEQUENCER WITH EEPROM

PCB DES: KIM T.  
APP ENG: NATHAN.E.

SIZE: IC NO. N/A  
REV: 3

DATE: Monday, January 19, 2015  
SHEET 1 OF 3

**APPROVALS**

SCALE = NONE

THIS CIRCUIT IS PROPRIETARY TO LINEAR TECHNOLOGY AND SUPPLIED FOR USE WITH LINEAR TECHNOLOGY PARTS.

**CUSTOMER NOTICE**

LINEAR TECHNOLOGY HAS MADE A BEST EFFORT TO DESIGN A CIRCUIT THAT MEETS CUSTOMER-SUPPLIED SPECIFICATIONS. HOWEVER, IT REMAINS THE CUSTOMER'S RESPONSIBILITY TO VERIFY THE PERFORMANCE OF THE CIRCUIT IN THEIR FINAL APPLICATION. COMPONENT SUBSTITUTION AND PRINTED CIRCUIT BOARD LAYOUT MAY SIGNIFICANTLY AFFECT CIRCUIT PERFORMANCE OR RELIABILITY. CONTACT LINEAR TECHNOLOGY APPLICATIONS ENGINEERING FOR ASSISTANCE.

# DEMO MANUAL DC2313A

## SCHEMATIC DIAGRAM

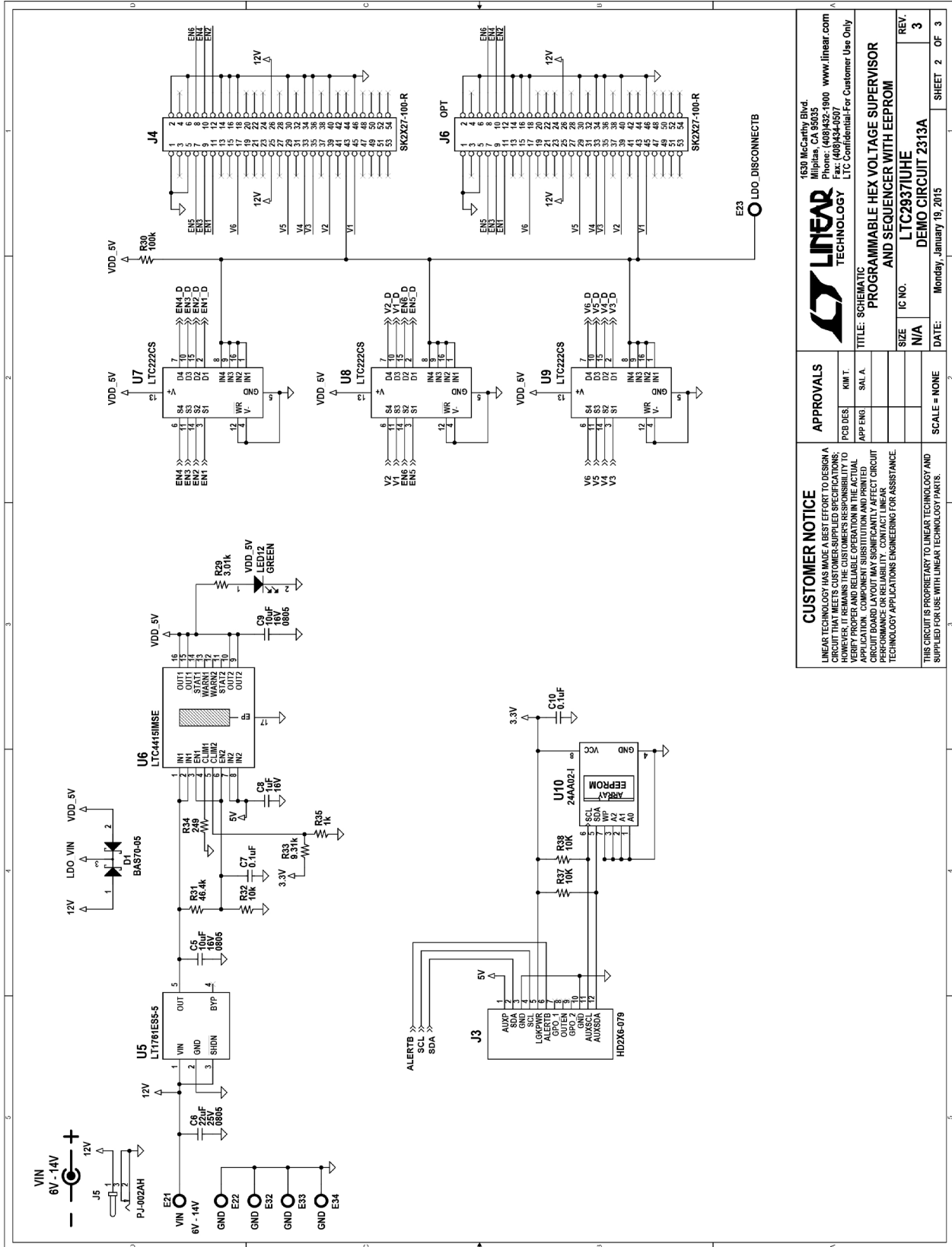

<b>APPROVALS</b>		1630 McCarthy Blvd. Milpitas, CA 95035 Phone: (408)432-1900 www.linear.com Fax: (408)434-0507 LTC Confidential-For Customer Use Only	
PCB DES	KIM.T	TITLE: SCHEMATIC PROGRAMMABLE HEX VOLTAGE SUPERVISOR AND SEQUENCER WITH EEPROM	
APP ENG	SAL.A		
SIZE	N/A	IC NO.	LTC2937IUHE
SCALE	NONE	REV.	3
THIS CIRCUIT IS PROPRIETARY TO LINEAR TECHNOLOGY AND SUPPLIED FOR USE WITH LINEAR TECHNOLOGY PARTS.		DATE:	Monday, January 19, 2015
		SHEET	2 OF 3

**CUSTOMER NOTICE**  
 LINEAR TECHNOLOGY HAS MADE A BEST EFFORT TO DESIGN A CIRCUIT THAT MEETS CUSTOMER-SUPPLIED SPECIFICATIONS. CUSTOMERS ARE RESPONSIBLE FOR VERIFYING THAT THE CIRCUIT MEETS THEIR REQUIREMENTS. CUSTOMERS SHOULD VERIFY PROPER AND RELIABLE OPERATION IN THE ACTUAL APPLICATION. COMPONENT SUBSTITUTION AND PRINTED CIRCUIT BOARD LAYOUT MAY SIGNIFICANTLY AFFECT CIRCUIT PERFORMANCE. CUSTOMERS SHOULD CONTACT LINEAR TECHNOLOGY APPLICATIONS ENGINEERING FOR ASSISTANCE.

LINEAR TECHNOLOGY  
 TECHNOLOGY

**SCHEMATIC DIAGRAM**

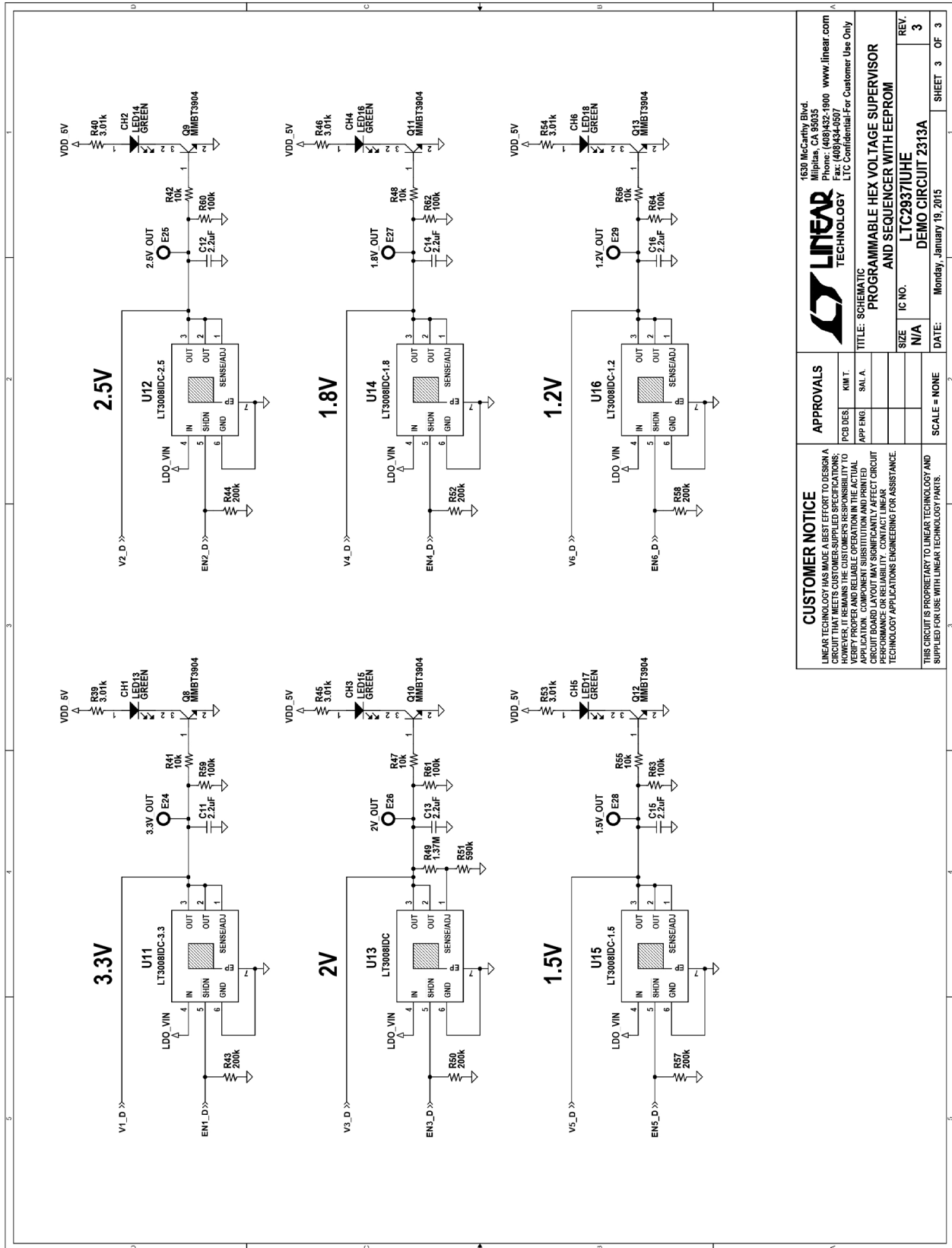

<b>CUSTOMER NOTICE</b>		<b>APPROVALS</b>	
LINEAR TECHNOLOGY HAS MADE A BEST EFFORT TO DESIGN A CIRCUIT THAT MEETS CUSTOMER-SUPPLIED SPECIFICATIONS. CUSTOMERS ARE RESPONSIBLE FOR VERIFYING THAT THE ACTUAL APPLICATION COMPONENTS MEET THE SPECIFICATIONS AND THAT THE ACTUAL BOARD LAYOUT MAY SIGNIFICANTLY AFFECT CIRCUIT PERFORMANCE. LINEAR TECHNOLOGY CONTACTS CUSTOMER TECHNOLOGY APPLICATIONS ENGINEERING FOR ASSISTANCE.		PCB DES	REV. 3
		DATE	Monday, January 19, 2015
		SCALE	NONE
		TITLE	PROGRAMMABLE HEX VOLTAGE SUPERVISOR AND SEQUENCER WITH EEPROM
		IC NO.	LTC2937IUHE
		SIZE	N/A
		REV.	3
		SHEET	3 OF 3

**LINEAR TECHNOLOGY**  
 1630 McCarthy Blvd.  
 Milpitas, CA 95035  
 Phone: (408)432-1900 www.linear.com  
 Fax: (408)434-0507  
 LTC Confidential-For Customer Use Only

# DEMO MANUAL DC2313A

---

## DEMONSTRATION BOARD IMPORTANT NOTICE

Linear Technology Corporation (LTC) provides the enclosed product(s) under the following **AS IS** conditions:

This demonstration board (DEMO BOARD) kit being sold or provided by Linear Technology is intended for use for **ENGINEERING DEVELOPMENT OR EVALUATION PURPOSES ONLY** and is not provided by LTC for commercial use. As such, the DEMO BOARD herein may not be complete in terms of required design-, marketing-, and/or manufacturing-related protective considerations, including but not limited to product safety measures typically found in finished commercial goods. As a prototype, this product does not fall within the scope of the European Union directive on electromagnetic compatibility and therefore may or may not meet the technical requirements of the directive, or other regulations.

If this evaluation kit does not meet the specifications recited in the DEMO BOARD manual the kit may be returned within 30 days from the date of delivery for a full refund. **THE FOREGOING WARRANTY IS THE EXCLUSIVE WARRANTY MADE BY THE SELLER TO BUYER AND IS IN LIEU OF ALL OTHER WARRANTIES, EXPRESSED, IMPLIED, OR STATUTORY, INCLUDING ANY WARRANTY OF MERCHANTABILITY OR FITNESS FOR ANY PARTICULAR PURPOSE. EXCEPT TO THE EXTENT OF THIS INDEMNITY, NEITHER PARTY SHALL BE LIABLE TO THE OTHER FOR ANY INDIRECT, SPECIAL, INCIDENTAL, OR CONSEQUENTIAL DAMAGES.**

The user assumes all responsibility and liability for proper and safe handling of the goods. Further, the user releases LTC from all claims arising from the handling or use of the goods. Due to the open construction of the product, it is the user's responsibility to take any and all appropriate precautions with regard to electrostatic discharge. Also be aware that the products herein may not be regulatory compliant or agency certified (FCC, UL, CE, etc.).

No License is granted under any patent right or other intellectual property whatsoever. **LTC assumes no liability for applications assistance, customer product design, software performance, or infringement of patents or any other intellectual property rights of any kind.**

LTC currently services a variety of customers for products around the world, and therefore this transaction **is not exclusive**.

**Please read the DEMO BOARD manual prior to handling the product.** Persons handling this product must have electronics training and observe good laboratory practice standards. **Common sense is encouraged.**

This notice contains important safety information about temperatures and voltages. For further safety concerns, please contact a LTC application engineer.

Mailing Address:

Linear Technology  
1630 McCarthy Blvd.  
Milpitas, CA 95035

Copyright © 2004, Linear Technology Corporation