

NTND31015NZ

Small Signal MOSFET

20 V, 200 mA, Dual N-Channel,
0.65 mm x 0.90 mm x 0.4 mm XLLGA-6
Package



ON Semiconductor®

www.onsemi.com

Features

- Dual N-Channel MOSFET
- Offers a Low $R_{DS(ON)}$ Solution in the Ultra Small 0.65 mm x 0.90 mm Package
- These Devices are Pb-Free, Halogen Free/BFR Free and are RoHS Compliant

Applications

- Small Signal Load Switch
- Analog Switch
- High Speed Interfacing
- Optimized for Power Management in Ultra Portable Products

MAXIMUM RATINGS ($T_J = 25^\circ\text{C}$ unless otherwise specified)

Parameter		Symbol	Value	Unit	
Drain-to-Source Voltage		V_{DSS}	20	V	
Gate-to-Source Voltage		V_{GS}	± 8	V	
Continuous Drain Current (Note 1)	Steady State	$T_A = 25^\circ\text{C}$	I_D	200	mA
			$T_A = 85^\circ\text{C}$	140	
	$t \leq 5 \text{ s}$	$T_A = 25^\circ\text{C}$	220		
Power Dissipation (Note 1)	Steady State	$T_A = 25^\circ\text{C}$	P_D	125	mW
	$t \leq 5 \text{ s}$			166	
Pulsed Drain Current		$t_p = 10 \mu\text{s}$	I_{DM}	800	mA
Operating Junction and Storage Temperature		T_J, T_{STG}	-55 to 150		$^\circ\text{C}$
Source Current (Body Diode) (Note 2)		I_S	200		mA
Lead Temperature for Soldering Purposes (1/8" from case for 10 s)		T_L	260		$^\circ\text{C}$

Stresses exceeding those listed in the Maximum Ratings table may damage the device. If any of these limits are exceeded, device functionality should not be assumed, damage may occur and reliability may be affected.

1. Surface-mounted on FR4 board using the minimum recommended pad size, 1 oz Cu.
2. Pulse Test: pulse width $\leq 300 \mu\text{s}$, duty cycle $\leq 2\%$

$V_{(BR)DSS}$	$R_{DS(ON)} \text{ MAX}$	$I_D \text{ Max}$
20 V	1.5 Ω @ 4.5 V	200 mA
	2.0 Ω @ 2.5 V	
	3.0 Ω @ 1.8 V	
	4.5 Ω @ 1.5 V	

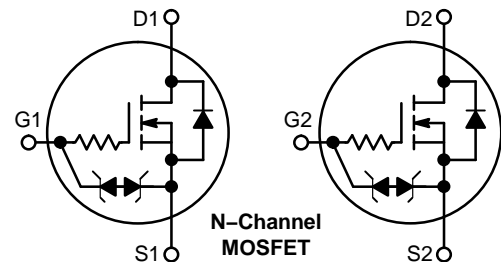

XLLGA6
Case 713AC

PINOUT DIAGRAM

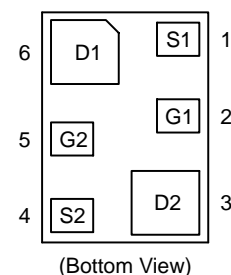

MARKING DIAGRAM



D = Specific Device Code
M = Date Code

ORDERING INFORMATION

See detailed ordering and shipping information on page 2 of this data sheet.

NTND31015NZ

THERMAL RESISTANCE RATINGS

Parameter	Symbol	Max	Unit
Junction-to-Ambient – Steady State (Note 3)	$R_{\theta JA}$	998	°C/W
Junction-to-Ambient – $t \leq 5$ s (Note 3)		751	

3. Surface-mounted on FR4 board using the minimum recommended pad size, 1 oz Cu.

ELECTRICAL CHARACTERISTICS ($T_J = 25^\circ\text{C}$ unless otherwise specified)

Parameter	Symbol	Test Condition	Min	Typ	Max	Unit
OFF CHARACTERISTICS						
Drain-to-Source Breakdown Voltage	$V_{(BR)DSS}$	$V_{GS} = 0\text{ V}, I_D = 250\ \mu\text{A}$	20			V
Zero Gate Voltage Drain Current	I_{DSS}	$V_{GS} = 0\text{ V}, V_{DS} = 5\text{ V}$	$T_J = 25^\circ\text{C}$		50	nA
			$T_J = 85^\circ\text{C}$		200	nA
		$V_{GS} = 0\text{ V}, V_{DS} = 16\text{ V}$	$T_J = 25^\circ\text{C}$		100	nA
Gate-to-Source Leakage Current	I_{GSS}	$V_{DS} = 0\text{ V}, V_{GS} = \pm 5.0\text{ V}$			± 100	nA

ON CHARACTERISTICS (Note 4)

Gate Threshold Voltage	$V_{GS(TH)}$	$V_{GS} = V_{DS}, I_D = 250\ \mu\text{A}$	0.4		1.0	V
Drain-to-Source On Resistance	$R_{DS(ON)}$	$V_{GS} = 4.5\text{ V}, I_D = 100\text{ mA}$		0.8	1.5	Ω
		$V_{GS} = 2.5\text{ V}, I_D = 50\text{ mA}$		1.1	2.0	
		$V_{GS} = 1.8\text{ V}, I_D = 20\text{ mA}$		1.4	3.0	
		$V_{GS} = 1.5\text{ V}, I_D = 10\text{ mA}$		1.8	4.5	
Forward Transconductance	g_{FS}	$V_{DS} = 5.0\text{ V}, I_D = 125\text{ mA}$		0.48		S
Forward Diode Voltage	V_{SD}	$V_{GS} = 0\text{ V}, I_S = 10\text{ mA}$		0.6	1.0	V

CAPACITANCES

Input Capacitance	C_{ISS}	$f = 1\text{ MHz}, V_{GS} = 0\text{ V}$ $V_{DS} = 15\text{ V}$		12.3		pF
Output Capacitance	C_{OSS}			3.4		
Reverse Transfer Capacitance	C_{RSS}			2.5		

SWITCHING CHARACTERISTICS, $V_{GS} = 4.5\text{ V}$ (Note 4)

Turn-On Delay Time	$t_{d(ON)}$	$V_{GS} = 4.5\text{ V}, V_{DD} = 10\text{ V},$ $I_D = 200\text{ mA}, R_G = 3\ \Omega$		16.5		ns
Rise Time	t_r			25.5		
Turn-Off Delay Time	$t_{d(OFF)}$			142		
Fall Time	t_f			80		

Product parametric performance is indicated in the Electrical Characteristics for the listed test conditions, unless otherwise noted. Product performance may not be indicated by the Electrical Characteristics if operated under different conditions.

4. Switching characteristics are independent of operating junction temperatures.

ORDERING INFORMATION

Device	Package	Shipping [†]
NTND31015NZTAG	XLLGA6 (Pb-Free)	8000 / Tape & Reel

[†]For information on tape and reel specifications, including part orientation and tape sizes, please refer to our Tape and Reel Packaging Specifications Brochure, BRD8011/D.

TYPICAL CHARACTERISTICS

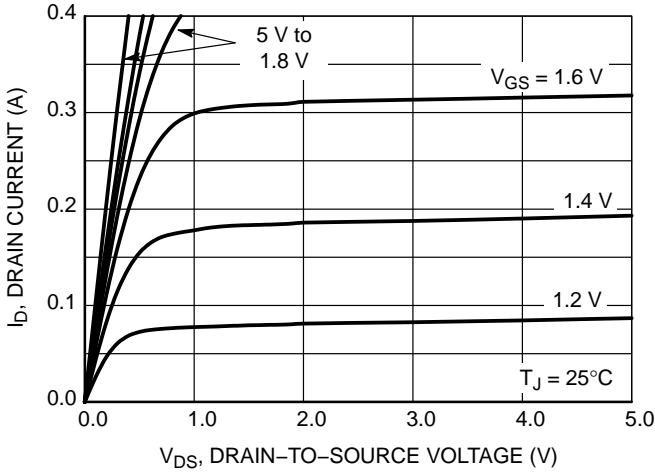

Figure 1. On-Region Characteristics

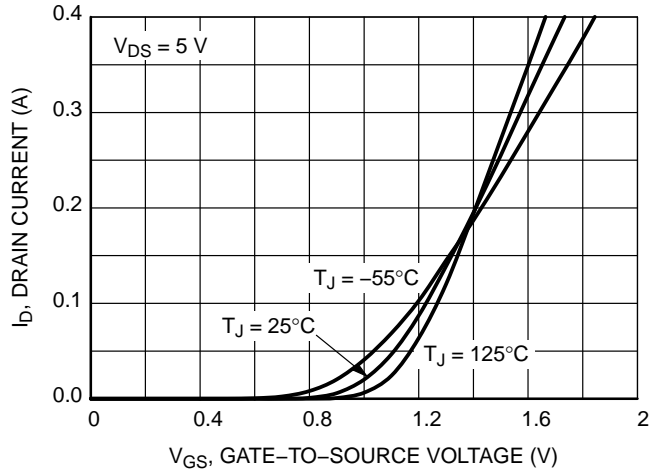

Figure 2. Transfer Characteristics

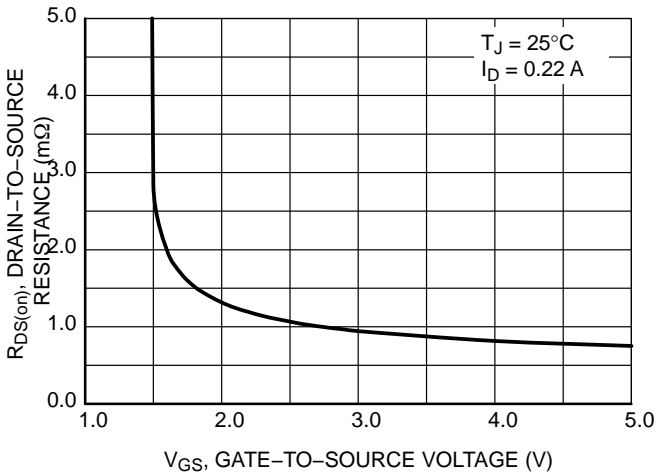

Figure 3. On-Resistance vs. Gate-to-Source Voltage

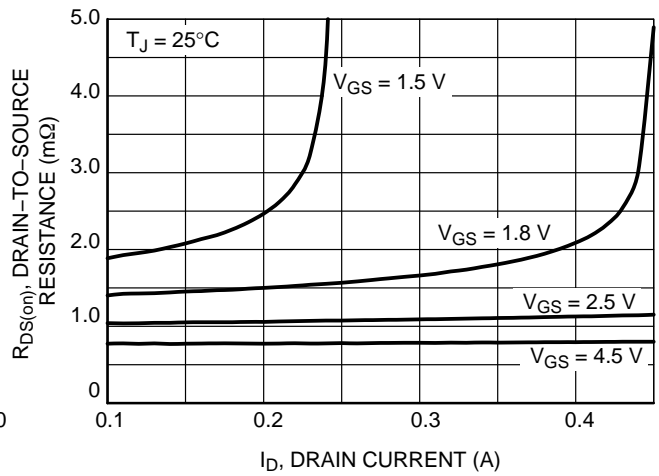

Figure 4. On-Resistance vs. Drain Current and Gate Voltage

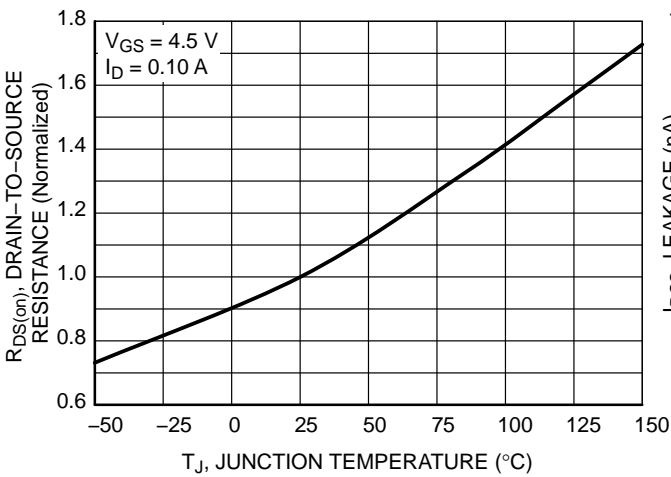

Figure 5. On-Resistance Variation with Temperature

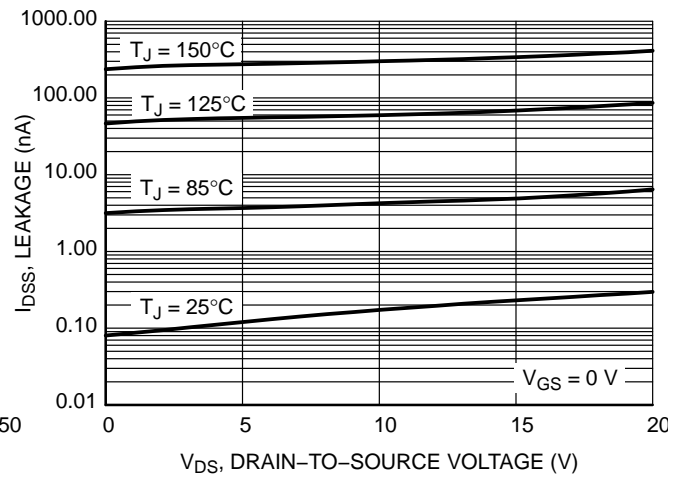

Figure 6. Drain-to-Source Leakage Current vs. Voltage

NTND31015NZ

TYPICAL CHARACTERISTICS

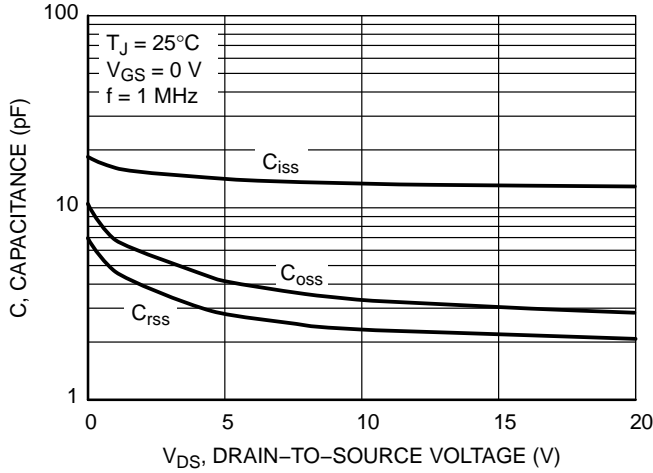

Figure 7. Capacitance Variation

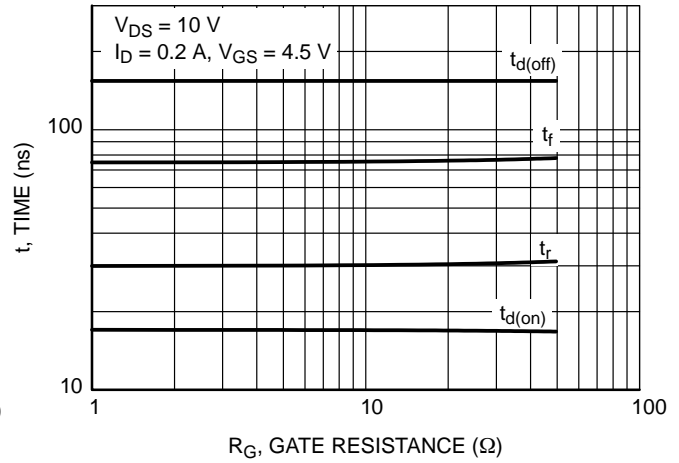

Figure 8. Resistive Switching Time Variation vs. Gate Resistance

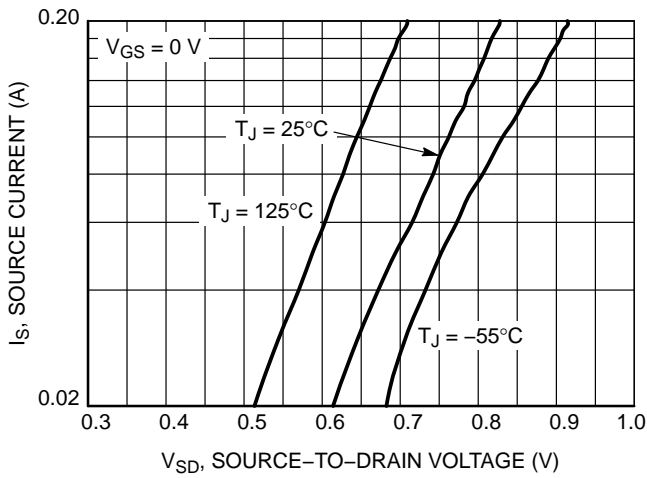

Figure 9. Diode Forward Voltage vs. Current

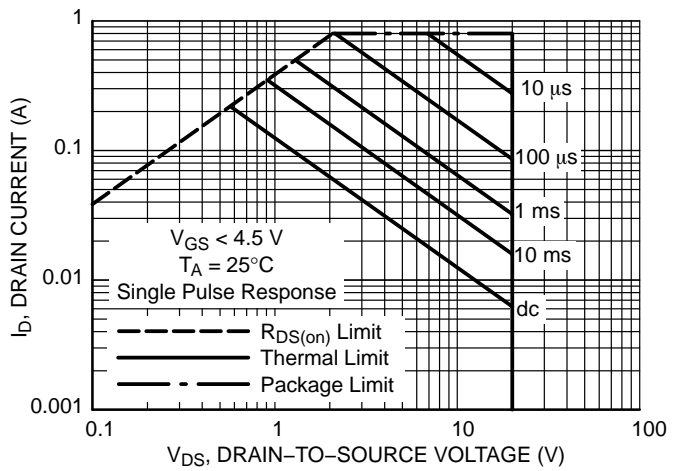

Figure 10. Maximum Rated Forward Biased Safe Operating Area

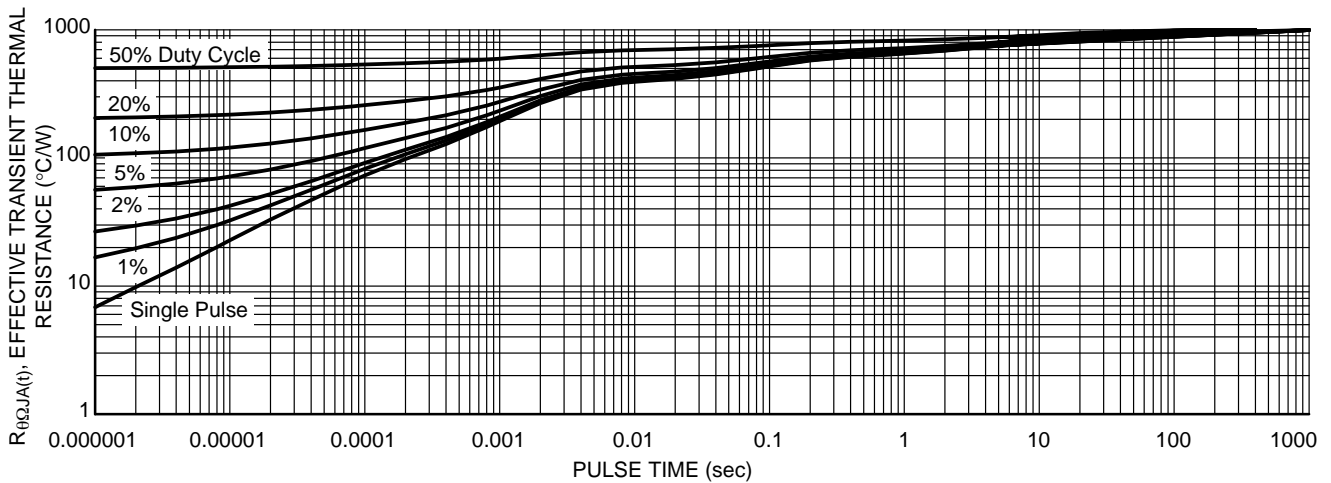
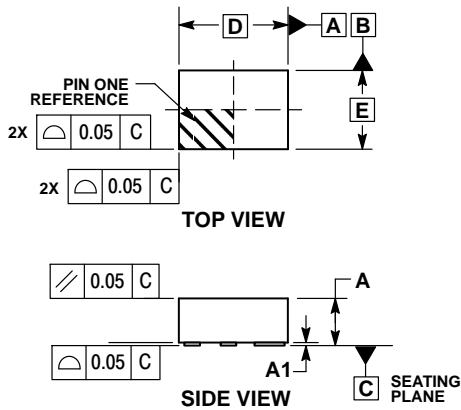

Figure 11. Thermal Response

NTND31015NZ

PACKAGE DIMENSIONS

XLLGA6 0.90x0.65 CASE 713AC ISSUE O



- NOTES:
1. DIMENSIONING AND TOLERANCING PER ASME Y14.5M, 1994.
 2. CONTROLLING DIMENSION: MILLIMETERS.
 3. POSITIONAL TOLERANCE APPLIES TO ALL SIX LEADS.

DIM	MILLIMETERS	
	MIN	MAX
A	0.340	0.440
A1	0.000	0.050
b	0.200	0.300
b2	0.080	0.180
D	0.900 BSC	
E	0.650 BSC	
e	0.295 BSC	
e1	0.340 BSC	
e2	0.300 BSC	
e3	0.208 BSC	
e4	0.158 BSC	
L	0.215	0.315
L2	0.115	0.215

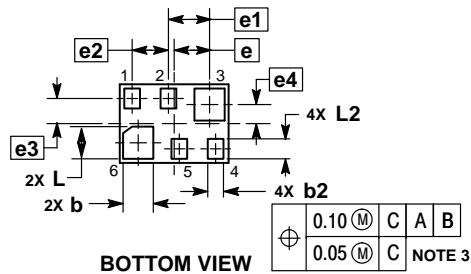

RECOMMENDED SOLDERING FOOTPRINT*

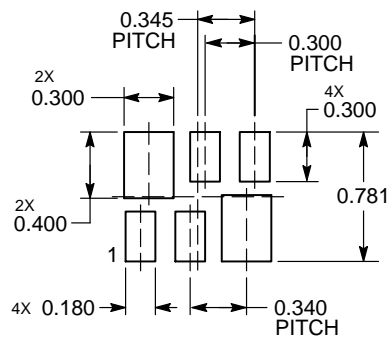

DIMENSIONS: MILLIMETERS

*For additional information on our Pb-Free strategy and soldering details, please download the ON Semiconductor Soldering and Mounting Techniques Reference Manual, SOLDERRM/D.

ON Semiconductor and the are registered trademarks of Semiconductor Components Industries, LLC (SCILLC) or its subsidiaries in the United States and/or other countries. SCILLC owns the rights to a number of patents, trademarks, copyrights, trade secrets, and other intellectual property. A listing of SCILLC's product/patent coverage may be accessed at www.onsemi.com/site/pdf/Patent-Marking.pdf. SCILLC reserves the right to make changes without further notice to any products herein. SCILLC makes no warranty, representation or guarantee regarding the suitability of its products for any particular purpose, nor does SCILLC assume any liability arising out of the application or use of any product or circuit, and specifically disclaims any and all liability, including without limitation special, consequential or incidental damages. "Typical" parameters which may be provided in SCILLC data sheets and/or specifications can and do vary in different applications and actual performance may vary over time. All operating parameters, including "Typicals" must be validated for each customer application by customer's technical experts. SCILLC does not convey any license under its patent rights nor the rights of others. SCILLC products are not designed, intended, or authorized for use as components in systems intended for surgical implant into the body, or other applications intended to support or sustain life, or for any other application in which the failure of the SCILLC product could create a situation where personal injury or death may occur. Should Buyer purchase or use SCILLC products for any such unintended or unauthorized application, Buyer shall indemnify and hold SCILLC and its officers, employees, subsidiaries, affiliates, and distributors harmless against all claims, costs, damages, and expenses, and reasonable attorney fees arising out of, directly or indirectly, any claim of personal injury or death associated with such unintended or unauthorized use, even if such claim alleges that SCILLC was negligent regarding the design or manufacture of the part. SCILLC is an Equal Opportunity/Affirmative Action Employer. This literature is subject to all applicable copyright laws and is not for resale in any manner.

PUBLICATION ORDERING INFORMATION

LITERATURE FULFILLMENT:

Literature Distribution Center for ON Semiconductor
P.O. Box 5163, Denver, Colorado 80217 USA
Phone: 303-675-2175 or 800-344-3860 Toll Free USA/Canada
Fax: 303-675-2176 or 800-344-3867 Toll Free USA/Canada
Email: orderlit@onsemi.com

N. American Technical Support: 800-282-9855 Toll Free
USA/Canada
Europe, Middle East and Africa Technical Support:
Phone: 421 33 790 2910
Japan Customer Focus Center
Phone: 81-3-5817-1050

ON Semiconductor Website: www.onsemi.com
Order Literature: <http://www.onsemi.com/orderlit>

For additional information, please contact your local Sales Representative