

| NO. | MASSE / DIMENSION |
|-----|-------------------|
| A | 1 1/2-18NEF-2A |
| B | 20.6 |
| C | 4 |
| D | 34.2 |
| E | 35.3 |
| F | 34.9 |
| G | 44.5 |
| H | 3.7 |

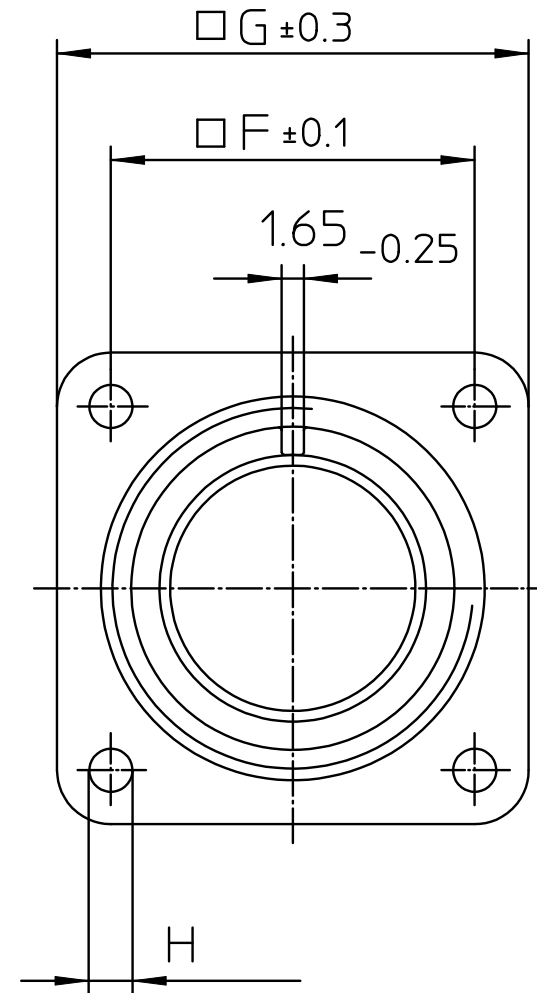

| NO. | BESCHREIBUNG / DESCRIPTION |
|-----|---|
| 2 | ISOLIERKÖRPER BUCHSE / INSULATOR SOCKET |
| 6 | KONTAKTBUCHSE / CONTACT SOCKET |
| 8 | DOSENGEHÄUSE / SHELL |

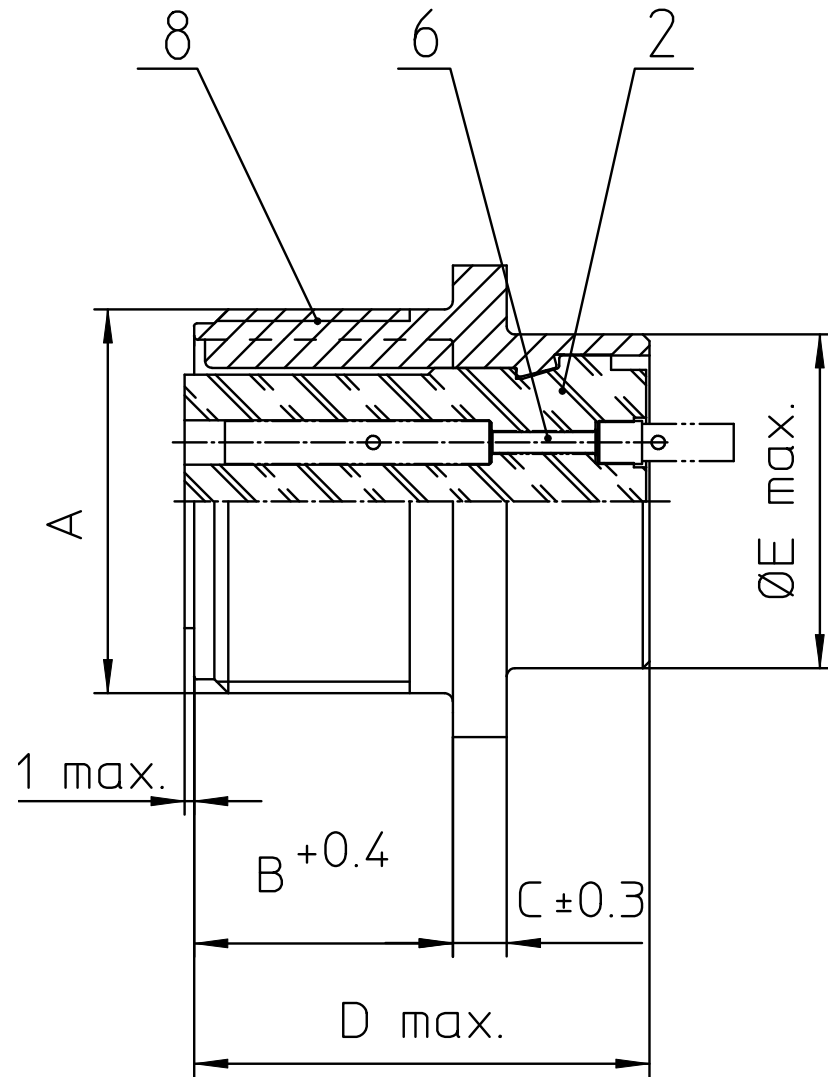
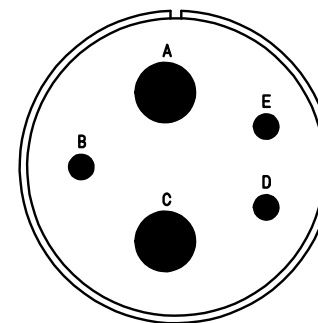

Note: Due to an automatic nomenclature system, numbers generated may not be sequential.
 Specification and Dimensions subject to change
 Drawings illustrate normal insulator positioning

| Material Specification: |
|---|
| Shell Material: Aluminium alloy |
| Shell Plating: Olive drab chromate coating over cadmium plating |
| Insulator Material: Neoprene |
| Contact Material: Copper alloy |
| Contact Plating: Hard silver |

all dimensions are in mm
 Dimensions without tolerance indications are general tolerances in acc. with DIN7168m

drawing for
 CUSTOMER



description CA3102E24-12S-F80
 Box mounting receptacle
 AWG Crimp / Socket / Layout: 24-12