



Is Now Part of



ON Semiconductor®

To learn more about ON Semiconductor, please visit our website at
www.onsemi.com

ON Semiconductor and the ON Semiconductor logo are trademarks of Semiconductor Components Industries, LLC dba ON Semiconductor or its subsidiaries in the United States and/or other countries. ON Semiconductor owns the rights to a number of patents, trademarks, copyrights, trade secrets, and other intellectual property. A listing of ON Semiconductor's product/patent coverage may be accessed at www.onsemi.com/site/pdf/Patent-Marking.pdf. ON Semiconductor reserves the right to make changes without further notice to any products herein. ON Semiconductor makes no warranty, representation or guarantee regarding the suitability of its products for any particular purpose, nor does ON Semiconductor assume any liability arising out of the application or use of any product or circuit, and specifically disclaims any and all liability, including without limitation special, consequential or incidental damages. Buyer is responsible for its products and applications using ON Semiconductor products, including compliance with all laws, regulations and safety requirements or standards, regardless of any support or applications information provided by ON Semiconductor. "Typical" parameters which may be provided in ON Semiconductor data sheets and/or specifications can and do vary in different applications and actual performance may vary over time. All operating parameters, including "Typicals" must be validated for each customer application by customer's technical experts. ON Semiconductor does not convey any license under its patent rights nor the rights of others. ON Semiconductor products are not designed, intended, or authorized for use as a critical component in life support systems or any FDA Class 3 medical devices or medical devices with a same or similar classification in a foreign jurisdiction or any devices intended for implantation in the human body. Should Buyer purchase or use ON Semiconductor products for any such unintended or unauthorized application, Buyer shall indemnify and hold ON Semiconductor and its officers, employees, subsidiaries, affiliates, and distributors harmless against all claims, costs, damages, and expenses, and reasonable attorney fees arising out of, directly or indirectly, any claim of personal injury or death associated with such unintended or unauthorized use, even if such claim alleges that ON Semiconductor was negligent regarding the design or manufacture of the part. ON Semiconductor is an Equal Opportunity/Affirmative Action Employer. This literature is subject to all applicable copyright laws and is not for resale in any manner.

NC7WZ02

TinyLogic® UHS Dual 2-Input NOR Gate

General Description

The NC7WZ02 is a dual 2-Input NOR Gate from Fairchild's Ultra High Speed Series of TinyLogic®. The device is fabricated with advanced CMOS technology to achieve ultra high speed with high output drive while maintaining low static power dissipation over a very broad V_{CC} operating range. The device is specified to operate over the 1.65V to 5.5V V_{CC} range. The inputs and output are high impedance when V_{CC} is 0V. Inputs tolerate voltages up to 7V independent of V_{CC} operating voltage.

Features

- Space saving US8 surface mount package
- MicroPak™ Pb-Free leadless package
- Ultra High Speed: t_{PD} 2.4ns typ into 50pF at 5V V_{CC}
- High Output Drive: ±24mA at 3V V_{CC}
- Broad V_{CC} Operating Range: 1.65V to 5.5V
- Matches the performance of LCX when operated at 3.3V V_{CC}
- Power down high impedance inputs/output
- Overvoltage tolerant inputs facilitate 5V to 3V translation
- Proprietary noise/EMI reduction circuitry implemented

Ordering Information

Order Number	Package Number	Package Code Top Mark	Package Description	Supplied As
NC7WZ02K8X	MAB08A	WZ02	8-Lead US8, JEDEC MO-187, Variation CA 3.1mm Wide	3k Units on Tape and Reel
NC7WZ02L8X	MAC08A	P5	Pb-Free 8-Lead MicroPak, 1.6 mm Wide	5k Units on Tape and Reel

Pb-Free package per JEDEC J-STD-020B.

Logic Symbol

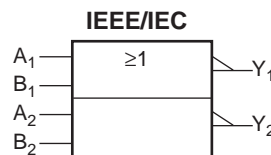

TinyLogic® is a registered trademark of Fairchild Semiconductor Corporation. MicroPak™ is a trademark of Fairchild Semiconductor Corporation.

Connection Diagrams

Pin Assignment for US8

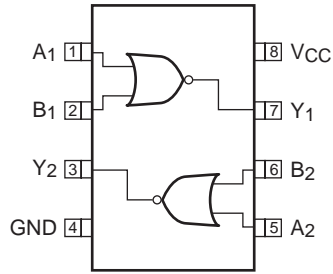

(Top View)

US8 Pin One Orientation Diagram

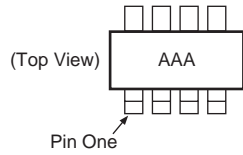

AAA represents Product Code Top Mark – see ordering code

Note: Orientation of Top Mark determines Pin One location. Read the top product code mark left to right, Pin One is the lower left pin (see diagram).

Pad Assignments for MicroPak

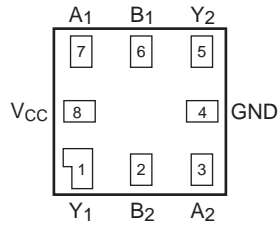

(Top Through View)

Pin Descriptions

Pin Name	Description
A_n, B_n	Inputs
Y_n	Outputs

Function Table

$$Y = \overline{A + B}$$

Inputs		Outputs
A	B	Y
L	L	H
L	H	L
H	L	L
H	H	L

H = HIGH Logic Level L = LOW Logic Level

Absolute Maximum Ratings

(The “Absolute Maximum Ratings” are those values beyond which the safety of the device cannot be guaranteed. The device should not be operated at these limits. The parametric values defined in the Electrical Characteristics tables are not guaranteed at the absolute maximum ratings. The “Recommended Operating Conditions” table will define the conditions for actual device operation.)

Symbol	Parameter	Rating
V _{CC}	Supply Voltage	-0.5V to +7V
V _{IN}	DC Input Voltage	-0.5V to +7V
V _{OUT}	DC Output Voltage	-0.5V to +7V
I _{IK}	DC Input Diode Current @ V _{IN} ≤ -0.5V	-50mA
I _{OK}	DC Output Diode Current @ V _{OUT} ≤ -0.5V	-50mA
I _{OUT}	DC Output Current	±50mA
I _{CC} /I _{GND}	DC V _{CC} /GND Current	±100mA
T _{STG}	Storage Temperature	-65°C to +150°C
T _J	Junction Temperature under Bias	150°C
T _L	Junction Lead Temperature (Soldering, 10 seconds)	260°C
P _D	Power Dissipation @ +85°C	250mW

Recommended Operating Conditions¹

Symbol	Parameter	Rating
V _{CC}	Supply Voltage Operating	1.65V to 5.5V
V _{CC}	Supply Voltage Data Retention	1.5V to 5.5V
V _{IN}	Input Voltage	0V to 5.5V
V _{OUT}	Output Voltage	0V to V _{CC}
T _A	Operating Temperature	-40°C to +85°C
t _r , t _f	Input Rise and Fall Time V _{CC} @ 1.8V±0.15V, 2.5V±0.2V V _{CC} @ 3.3V±0.3V V _{CC} @ 5.0V±0.5V	0ns/V to 20ns/V 0ns/V to 10ns/V 0ns/V to 5ns/V
θ _{JA}	Thermal Resistance	250°C/W

Notes:

1. Unused inputs must be held HIGH or LOW. They may not float.

DC Electrical Characteristics

Symbol	Parameter	Conditions	V _{CC} (V)	T _A =					Units
				25°C			-40°C to +85°C		
				Min	Typ	Max	Min	Max	
V _{IH}	HIGH Level Input Voltage		1.65 to 1.95	0.75 V _{CC}			0.75 V _{CC}		V
			2.3 to 5.5	0.7 V _{CC}			0.7 V _{CC}		
V _{IL}	LOW Level Input Voltage		1.65 to 1.95			0.25 V _{CC}		0.25 V _{CC}	V
			2.3 to 5.5			0.3 V _{CC}		0.3 V _{CC}	
V _{OH}	High Level Output Voltage	V _{IN} = V _{IL} , I _{OH} = -100μA	1.65	1.55	1.65		1.55		V
			2.3	2.2	2.3		2.2		
			3.0	2.9	3.0		2.9		
			4.5	4.4	4.5		4.4		
		I _{OH} = -4mA	1.65	1.29	1.52		1.29		
		I _{OH} = -8mA	2.3	1.9	2.15		1.9		
		I _{OH} = -16mA	3.0	2.4	2.80		2.4		
		I _{OH} = -24mA	3.0	2.3	2.68		2.3		
V _{OL}	Low Level Output Voltage	V _{IN} = V _{IH} , I _{OL} = 100μA	1.65		0.0	0.1		0.1	V
			2.3		0.0	0.1		0.1	
			3.0		0.0	0.1		0.1	
			4.5		0.0	0.1		0.1	
		I _{OL} = 4mA	1.65		0.08	0.24		0.24	
		I _{OL} = 8mA	2.3		0.10	0.3		0.3	
		I _{OL} = 16mA	3.0		0.15	0.4		0.4	
		I _{OL} = 24mA	3.0		0.22	0.55		0.55	
I _{IN}	Input Leakage Current	V _{IN} = 5.5V, GND	0 to 5.5			±0.1		±1.0	μA
I _{OFF}	Power OFF Leakage Current	V _{IN} or V _{OUT} = 5.5V	0.0			1		10	μA
I _{CC}	Quiescent Supply Current	V _{IN} = 5.5V, GND	1.65 to 5.5			1		10	μA

AC Electrical Characteristics

Symbol	Parameter	Conditions	V _{CC} (V)	T _A =					Units	Figure Number
				+25°C			-40°C to +85°C			
				Min	Typ	Max	Min	Max		
t _{PLH} , t _{PHL}	Propagation Delay	R _L = 1MΩ, C _L = 15pF	1.8 ± 0.15	2.0	5.4	9.8	2.0	10	ns	Figure 1 Figure 3
			2.5 ± 0.2	1.2	3.3	5.4	1.2	5.8		
			3.3 ± 0.3	0.8	2.5	3.8	0.8	4.1		
			5.0 ± 0.5	0.5	2.0	3.0	0.5	3.3		
t _{PLH} , t _{PHL}	Propagation Delay	R _L = 500Ω, C _L = 50pF	3.3 ± 0.3	1.2	3.1	4.6	1.2	5.0	ns	Figure 1 Figure 3
			5.0 ± 0.5	0.8	2.4	3.7	0.8	4.0		
C _{IN}	Input Capacitance		0		2.5				pF	
C _{PD}	Power Dissipation Capacitance	Note 2	3.3		13.5				pF	Figure 2
			5.0		17.5					

Notes:

2. C_{PD} is defined as the value of the internal equivalent capacitance which is derived from dynamic operating current consumption (I_{CCD}) at no output loading and operating at 50% duty cycle. (See Figure 2.) C_{PD} is related to I_{CCD} dynamic operating current by the expression:

$$C_{PD} = I_{CCD} / (V_{CC}) (F).$$

AC Loading and Waveforms

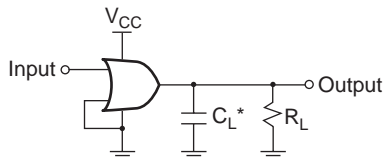

*C_L includes load and stray capacitance.
Input PRR = 1.0MHz; t_W = 500ns

Figure 1. AC Test Circuit

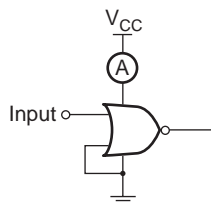

Input = AC Waveform; t_r, t_f = 1.8ns;
PRR = 10MHz; Duty Cycle = 50%

Figure 2. I_{CCD} Test Circuit

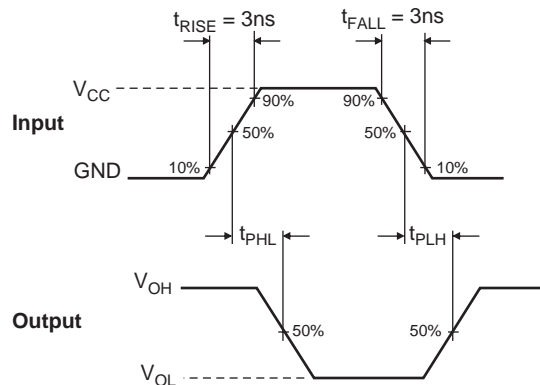

Figure 3. AC Waveforms

Tape and Reel Specification

Tape Format for MircoPak

Package Designator	Tape Section	Number Cavities	Cavity Status	Cover Tape Status
L8X	Leader (Start End)	125 (typ)	Empty	Sealed
	Carrier	3000	Filled	Sealed
	Trailer (Hub End)	75 (typ)	Empty	Sealed

Tape Dimension inches (millimeters)

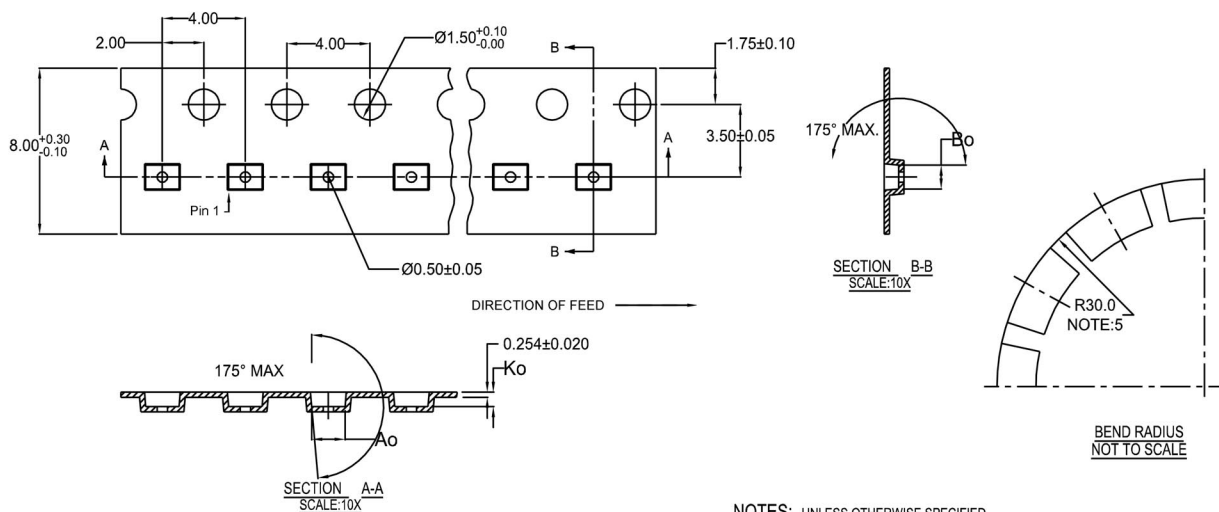

10	300056	2.30 ± 0.05	1.78 ± 0.05	0.68 ± 0.05
8	300038	1.78 ± 0.05	1.78 ± 0.05	0.68 ± 0.05
6	300033	1.60 ± 0.05	1.15 ± 0.05	0.70 ± 0.05

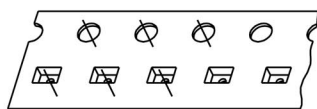

SCALE: 6X

NOTES: UNLESS OTHERWISE SPECIFIED

1. ACCUMULATED 50 SPROCKETS, SPROCKET HOLE PITCH IS 200.00 ± 0.30MM
2. NO INDICATED CORNER RADIUS IS 0.127MM
3. CAMBER NOT TO EXCEED 1MM IN 100MM
4. SMALLEST ALLOWABLE BENDING RADIUS
5. POCKET POSITION RELATIVE TO SPROCKET HOLE MEASURED AS TRUE POSITION OF POCKET, NOT POCKET HOLE

Reel Dimension for MircoPak inches (millimeters)

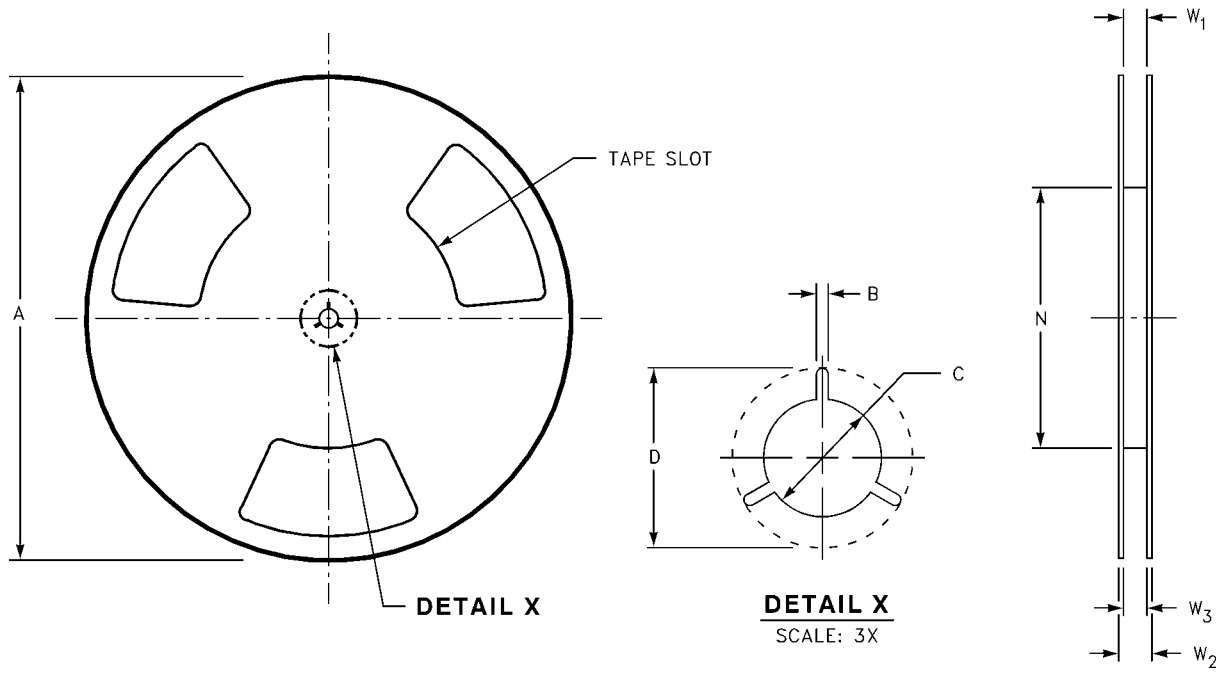

Tape Size	A	B	C	D	N	W1	W2	W3
8 mm	7.0 (177.8)	0.059 (1.50)	0.512 (13.00)	0.795 (20.20)	2.165 (55.00)	0.331 + 0.059/-0.000 (8.40 + 1.50/-0.00)	0.567 (14.40)	W1 + 0.078/-0.039 (W1 + 2.00/-1.00)

Tape Format for US8

Package Designator	Tape Section	Number Cavities	Cavity Status	Cover Tape Status
K8X	Leader (Start End)	125 (typ)	Empty	Sealed
	Carrier	3000	Filled	Sealed
	Trailer (Hub End)	75 (typ)	Empty	Sealed

Tape Dimension inches (millimeters)

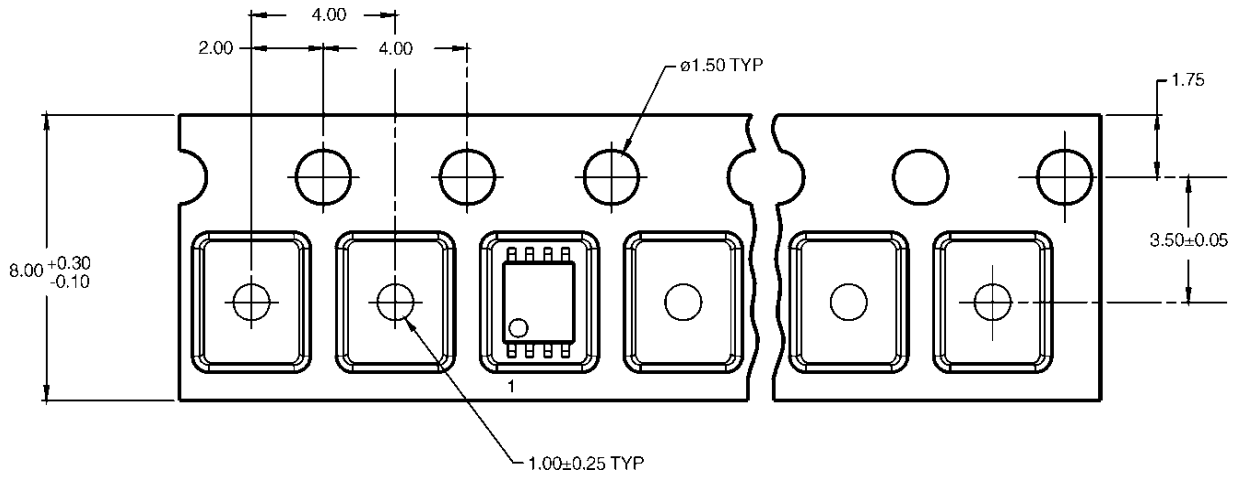

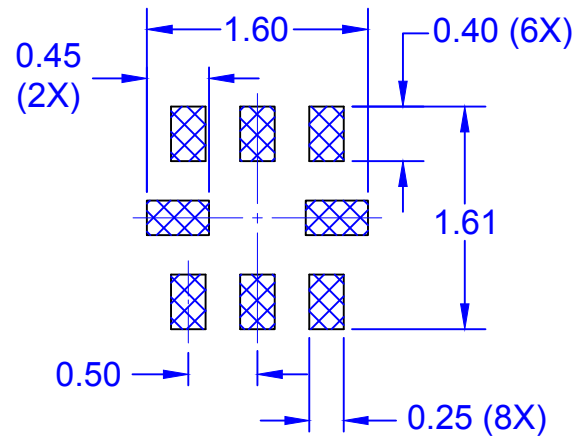
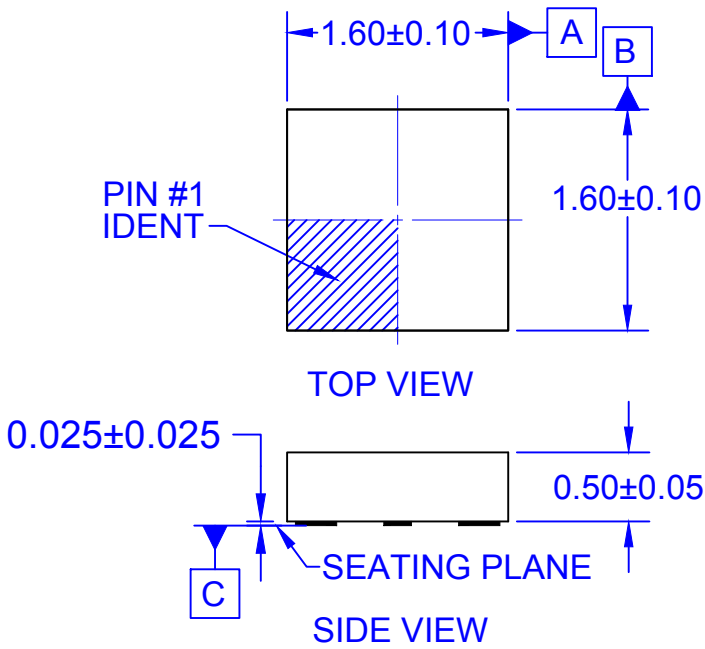

RECOMMENDED LAND PATTERN

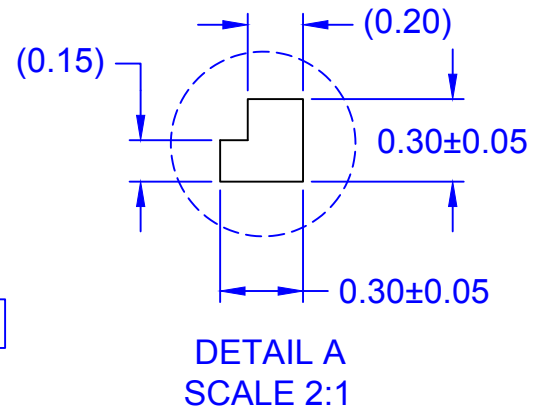
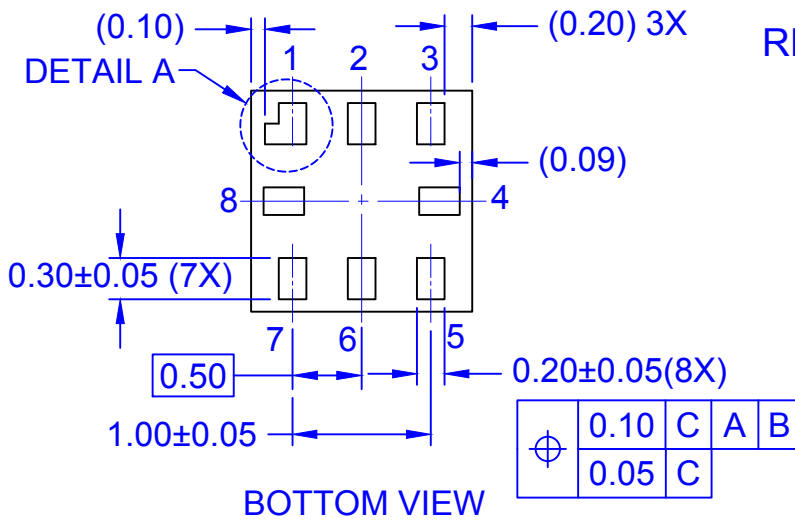

NOTES:

- A. PACKAGE CONFORMS TO JEDEC MO-255 VARIATION UAAD.
- B. DIMENSIONS ARE IN MILLIMETERS.
- C. LAND PATTERN RECOMMENDATION IS EXISTING INDUSTRY LAND PATTERN.
- D. DRAWING FILENAME: MKT-MAC08ArevE.

ON Semiconductor



ON Semiconductor and  are trademarks of Semiconductor Components Industries, LLC dba ON Semiconductor or its subsidiaries in the United States and/or other countries. ON Semiconductor owns the rights to a number of patents, trademarks, copyrights, trade secrets, and other intellectual property. A listing of ON Semiconductor's product/patent coverage may be accessed at www.onsemi.com/site/pdf/Patent-Marking.pdf. ON Semiconductor reserves the right to make changes without further notice to any products herein. ON Semiconductor makes no warranty, representation or guarantee regarding the suitability of its products for any particular purpose, nor does ON Semiconductor assume any liability arising out of the application or use of any product or circuit, and specifically disclaims any and all liability, including without limitation special, consequential or incidental damages. Buyer is responsible for its products and applications using ON Semiconductor products, including compliance with all laws, regulations and safety requirements or standards, regardless of any support or applications information provided by ON Semiconductor. "Typical" parameters which may be provided in ON Semiconductor data sheets and/or specifications can and do vary in different applications and actual performance may vary over time. All operating parameters, including "Typicals" must be validated for each customer application by customer's technical experts. ON Semiconductor does not convey any license under its patent rights nor the rights of others. ON Semiconductor products are not designed, intended, or authorized for use as a critical component in life support systems or any FDA Class 3 medical devices or medical devices with a same or similar classification in a foreign jurisdiction or any devices intended for implantation in the human body. Should Buyer purchase or use ON Semiconductor products for any such unintended or unauthorized application, Buyer shall indemnify and hold ON Semiconductor and its officers, employees, subsidiaries, affiliates, and distributors harmless against all claims, costs, damages, and expenses, and reasonable attorney fees arising out of, directly or indirectly, any claim of personal injury or death associated with such unintended or unauthorized use, even if such claim alleges that ON Semiconductor was negligent regarding the design or manufacture of the part. ON Semiconductor is an Equal Opportunity/Affirmative Action Employer. This literature is subject to all applicable copyright laws and is not for resale in any manner.

PUBLICATION ORDERING INFORMATION

LITERATURE FULFILLMENT:

Literature Distribution Center for ON Semiconductor
19521 E. 32nd Pkwy, Aurora, Colorado 80011 USA
Phone: 303-675-2175 or 800-344-3860 Toll Free USA/Canada
Fax: 303-675-2176 or 800-344-3867 Toll Free USA/Canada
Email: orderlit@onsemi.com

N. American Technical Support: 800-282-9855 Toll Free
USA/Canada
Europe, Middle East and Africa Technical Support:
Phone: 421 33 790 2910
Japan Customer Focus Center
Phone: 81-3-5817-1050

ON Semiconductor Website: www.onsemi.com
Order Literature: <http://www.onsemi.com/orderlit>
For additional information, please contact your local
Sales Representative