

---

**EVALSTPM34, EVALSTPM33, EVALSTPM32 evaluation board**

---

## Introduction

This user manual describes the EVALSTPM34, EVALSTPM33, EVALSTPM32 evaluation board.

The STPM3x is an ASSP family of mixed signals designed for high accuracy measurement of power and energy in power line systems using the Rogowski coil, current transformer or shunt current sensors. According to p/n, the device has up to two voltages and two current channels, for energy measurement in dual-phase and single-phase (with or without neutral current monitoring) electricity metering systems.

The STPM3x devices provide instantaneous voltage and current waveforms and calculate voltage and current RMS values, active, reactive and apparent powers and energies for each channel. Moreover, they embed a full set of calibration and compensation parameters which allow the meter to fit tight accuracy standards (EN 50470-x, IEC 62053-2x, ANSI12.2x for AC watt meters). All calculated data, as well as configuration parameters, are stored in internal 32-bit registers accessible through SPI or UART peripheral. Three boards are available for evaluation purpose:

- EVALSTPM34 board with 2 CT
- EVALSTPM33 board with CT and shunt
- EVALSTPM32 board with shunt

The main features of these boards are:

- 0.2% accuracy single-phase meter reference design
- USB port for connection to the isolated hardware programmer STEVAL-IPE023V1 and PC GUI
- RS232 and UART isolated port for connection to PC GUI
- SPI/UART switch for device peripheral selection
- 2x programmable LEDs on-board
- Digital expansion to external system-on-chip or MCU
- Power supply 3.3 V: external or through the STEVAL-IPE023V1 isolated USB board
- IEC61000 standard compliant

**Contents**

**1 Overview ..... 3**

    1.1 Safety rules ..... 4

    1.2 Operating conditions ..... 4

    1.3 Recommended readings ..... 5

    1.4 Getting technical support ..... 5

**2 EVALSTPM34, EVALSTPM33, EVALSTPM32 board..... 6**

    2.1 Board description ..... 6

        2.1.1 Hardware configuration ..... 6

        2.1.2 Power supply ..... 6

        2.1.3 Enable and reset ..... 6

        2.1.4 Digital output..... 7

        2.1.5 SPI connection ..... 7

        2.1.6 UART connection ..... 8

        2.1.7 Metrology ..... 8

        2.1.8 LED ..... 9

        2.1.9 Clock..... 9

        2.1.10 Voltage reference ..... 9

    2.2 Connection to the line ..... 9

    2.3 Board setup..... 12

        2.3.1 Connection to PC GUI through the STEVAL-IPE023V1 ..... 12

        2.3.2 Connection to PC GUI through the RS232 port ..... 12

    2.4 The device basic configuration ..... 13

**3 Revision history ..... 14**

# 1 Overview

Figure 1: EVALSTPM34 board

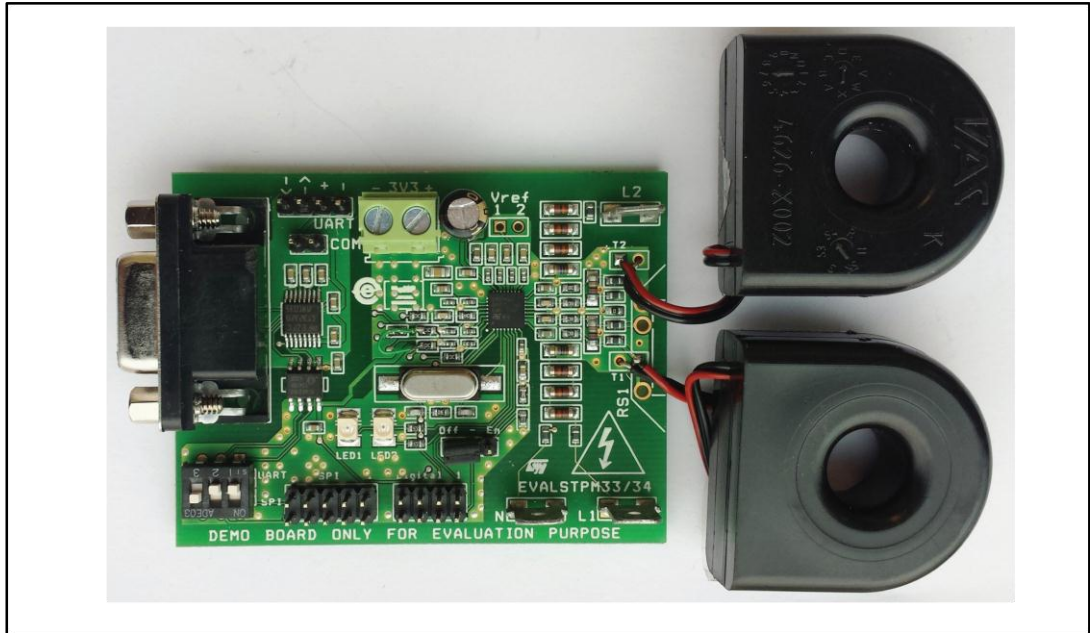

Figure 2: EVALSTPM33 board

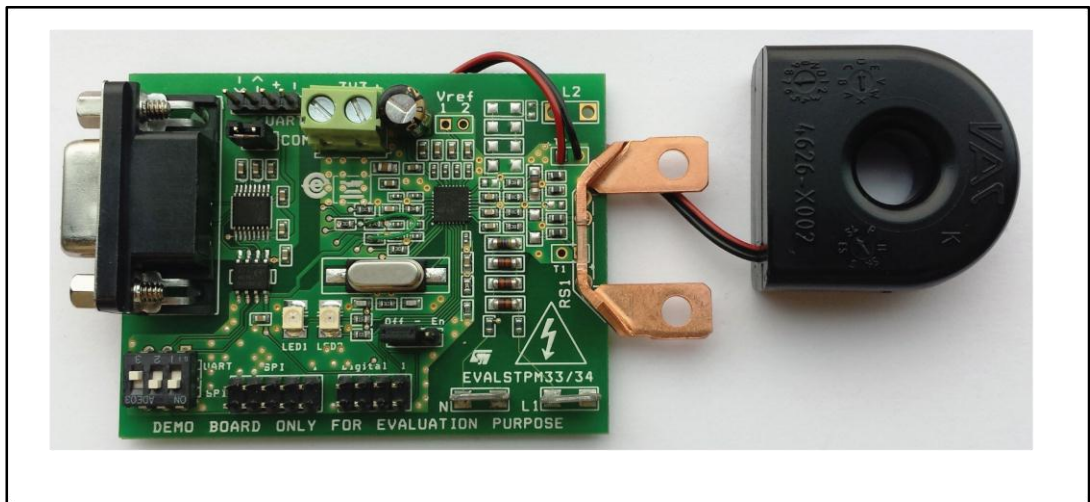
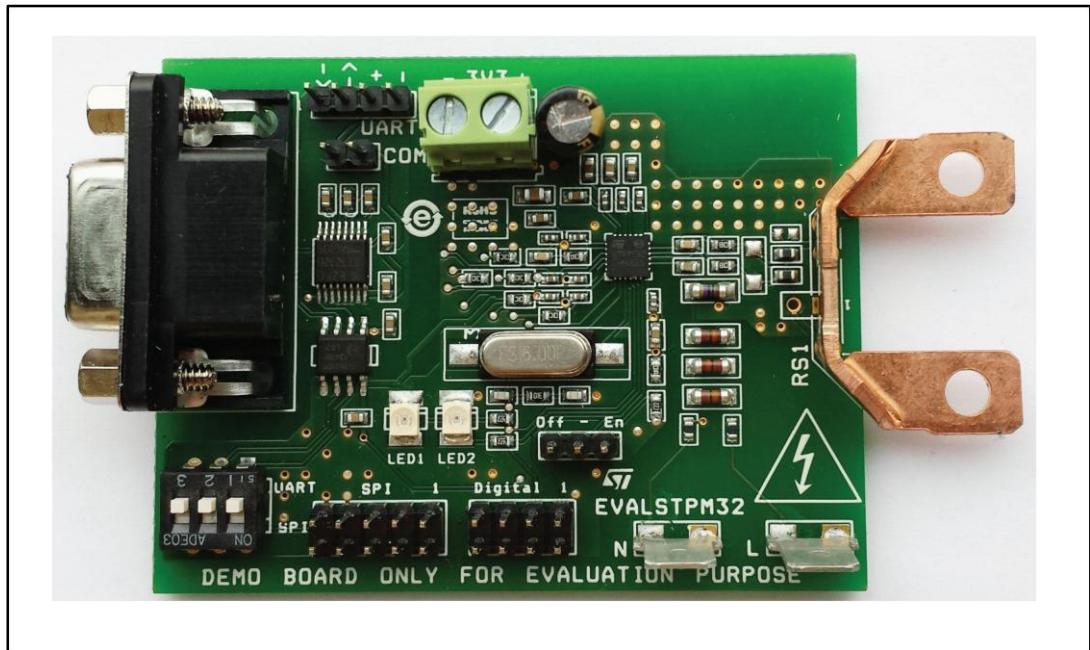

Figure 3: EVALSTPM32 board



## 1.1 Safety rules

These boards can be connected to the mains voltage (230 V/110 V). In the case of improper use, wrong installation or malfunction, there is a danger of serious personal injury and damage to property. All operations such as: transport, installation, and commissioning, as well as maintenance, should be carried out by skilled technical personnel (national accident prevention rules must be observed) only.

## 1.2 Operating conditions

Table 1: Operating conditions

Parameter	Value
$V_N$ nominal voltage	230 $V_{RMS}$
$I_N$ nominal current	5 $A_{RMS}$
$I_{max}$ maximum current	100 $A_{RMS}$
$C_P$ constant pulses	41600 imp/kWh
$f_{line}$ line frequency	50/60 Hz $\pm$ 10%
$T_{OP}$ operating temperature	-40/+85 °C

## 1.3 Recommended readings

This document describes how to use and set up a basic test session with a GUI interface. Additional information is available in the following documents:

- STPM3x datasheet
- AN4470
- UM1719
- EVALSTPM32 schematics
- EVALSTPM33 schematics
- EVALSTPM34 schematics

## 1.4 Getting technical support

All our customers receive free technical assistance through local ST distributor/office or by visiting [www.st.com](http://www.st.com); upgrades are also available free of charge on [www.st.com/metering](http://www.st.com/metering). Customers should work with the latest version of software/firmware before contacting us.

## 2 EVALSTPM34, EVALSTPM33, EVALSTPM32 board

### 2.1 Board description

#### 2.1.1 Hardware configuration

Table 2: EVALSTPM3x evaluation board setting and configuration terminals

Parameter	Value
J7	3.3 V external DC supply
J4	Device enable and reset
J5	Digital output pins
J6	SPI connector to the USB programmer/reader
J1	DB9 female connector for RS232 port
J2	UART isolated pin connector
J3	RS232 enable
J11 <sup>a</sup>	V <sub>REF</sub> jumper
SWC1	DIP switch for SPI/UART peripheral selection
L1	Primary voltage
L2 <sup>b</sup>	Secondary voltage
I1	Primary current
I2	Secondary current

#### 2.1.2 Power supply

The board does not contain a power supply. V<sub>CC</sub> = 3.3 V DC supply should be provided externally, by J7 connector. If the board is interfaced to PC by the STEVAL-IPE023V1 isolated dongle, it provides the board with supply. Since UART section is isolated, to use either RS232 or J2 UART connectors, a different isolated 3.3 V supply must be provided through J2 connector.

#### 2.1.3 Enable and reset

The STPM3x enable pin should be shorted to VCC by keeping J4 jumper in EN position. To reset the device, this jumper has to be in OFF position (GND).

<sup>a</sup> For the EVALSTPM34 and the EVALSTPM33 board only.

<sup>b</sup> For the EVALSTPM34 board only.

### 2.1.4 Digital output

8-pin J5 connector provides all digital output pins of the device as listed in the below table:

**Table 3: J5 connector pinout**

Connector pin	STPM3x pin
1	INT1
2	INT2 <sup>a</sup>
3	LED2
4	EN/RST
5	LED1
6	GND
7	CKIN/XTAL2
8	CKOUT/ZCR

### 2.1.5 SPI connection

To communicate with the device using the STEVAL-IPE023V1 isolated USB dongle, the STPM3x SPI peripheral has to be selected. All SWC1 switches have to be in OFF position before the device powers up. SPI pins are available in J6 connector for 10-pin flat cable interfacing either to the STEVAL-IPE023V1 or to an external MCU.

**Table 4: J6 SPI connector pinout**

Name	Description
1	Not connected
2	MOSI
3	GND
4	MISO
5	SCS
6	SCL
7	Not connected
8	SYN
9	Not connected
10	VCC

The STEVAL-IPE023V1 provides isolation, while J6 pins are not isolated.

<sup>a</sup> For the EVALSTPM34 and the EVALSTPM33 board only.

### 2.1.6 UART connection

UART peripheral also communicates to the device. In this case, all SWC1 switches should be in ON position when the device powers up. RS232 port is isolated from the board through Si8621 transceiver to safely connect the board to PC; in this case, J3 jumper has to be connected. UART isolated pins are also available on J2 connector for MCU connection; in this case J3 jumper has to be disconnected. If UART connection is used, a separate 3.3 VDC has to be provided to UART section.

**Table 5: J2 UART connector**

Name	Description
1	RXD
2	TXD
3	+3.3 VDC
4	GND

### 2.1.7 Metrology

Current sensing is performed by CT or shunt, while voltage is sensed by voltage dividers. The EVALSTPM34 board has two currents and two voltage channels, while the EVALSTPM33 has two currents and one voltage channel, the EVALSTPM32 has one current and one voltage channel available. Main design parameters are listed in the below table.

**Table 6: EVALSTPM3x evaluation board parameters**

Channel	Parameter	Value
Primary current	Current sensor sensitivity $k_s^a$	2.4 mV/A
	Shunt sensor sensitivity <sup>b</sup>	0.3 mV/A
Primary voltage	R <sub>1</sub> voltage divider upper resistor <sup>c</sup>	810000 $\Omega$
	R <sub>2</sub> voltage divider upper resistor	470 $\Omega$
Secondary current <sup>d</sup>	$k_s$ current sensor sensitivity	2.4 mV/A
Secondary voltage	R <sub>1</sub> voltage divider upper resistor	81000 $\Omega$
	R <sub>2</sub> voltage divider upper resistor	470 $\Omega$
Any	C <sub>P</sub> constant pulse	41600 pulses/kWh

A 22 nF capacitor in parallel with R2 implements an antialiasing filter for voltage signal. Regarding to current signal, the antialiasing filter is given by a 10 nF capacitor and 1 kOhm resistors.

<sup>a</sup> For the EVALSTPM34 board only.

<sup>b</sup> For the EVALSTPM32 and EVALSTPM33 board only.

<sup>c</sup> R<sub>1</sub>, R<sub>2</sub> names do not refer to specific resistors on the schematic, but these names indicate voltage divider resistors.

<sup>d</sup> For the EVALSTPM34 and EVALSTPM33 board.



### 2.1.8 LED

Two LEDs are connected to programmable LED pins of the device.

### 2.1.9 Clock

Clocking is provided to the board through 16 MHz quartz. 1 MOhm resistor and 15 pF capacitors are used to filter noise.

### 2.1.10 Voltage reference

The STPM34 and STPM33 devices embed two internal independent voltage references. J11 jumper shorts  $V_{REF}$ , or it can be used to connect the external precision voltage reference. The external reference should be connected between the desired  $V_{REF}$  and GND, if a single reference has to be used for both channels,  $V_{REF1}$  and  $V_{REF2}$  should be shorted by J11.

## 2.2 Connection to the line

The board can be connected to line voltage and current in several ways, as shown in below pictures.

Please note that, in boards using shunt, the shunt is at the same potential of voltage neutral faston and therefore it is at the same potential of the board GND. When isolated power sources are used or phantom loads, this is not important. In case of connection to the mains, this has to be taken into account since, according to the wire connected to the shunt, the board GND may be either at the 0 or 230 V potential.

Figure 4: Board connection to phantom load, dual-phase system (STPM34)

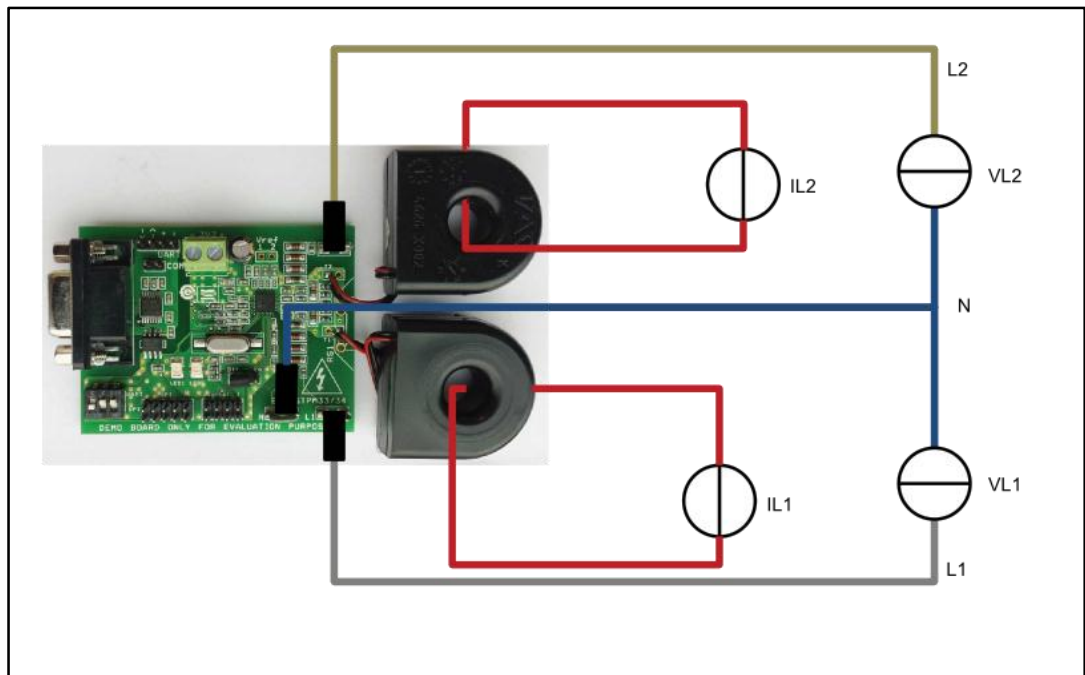

Figure 5: Board connection to phantom load, single-phase system with neutral monitoring (STPM34 and STPM33)

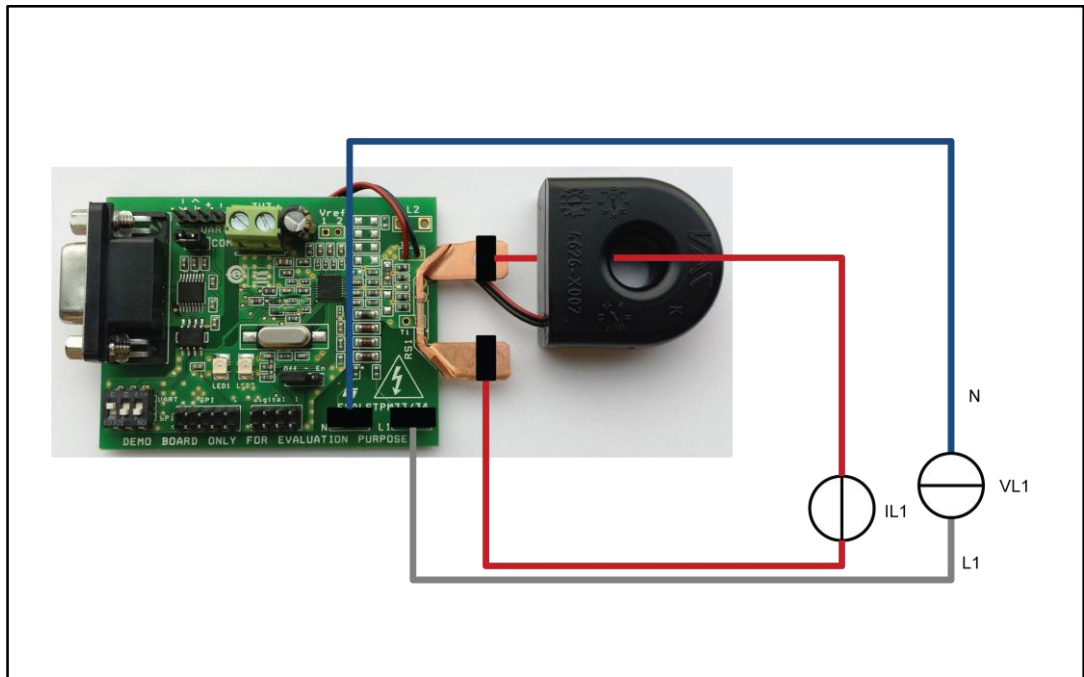

Figure 6: Board connection to phantom load, single-phase system (STPM3x)

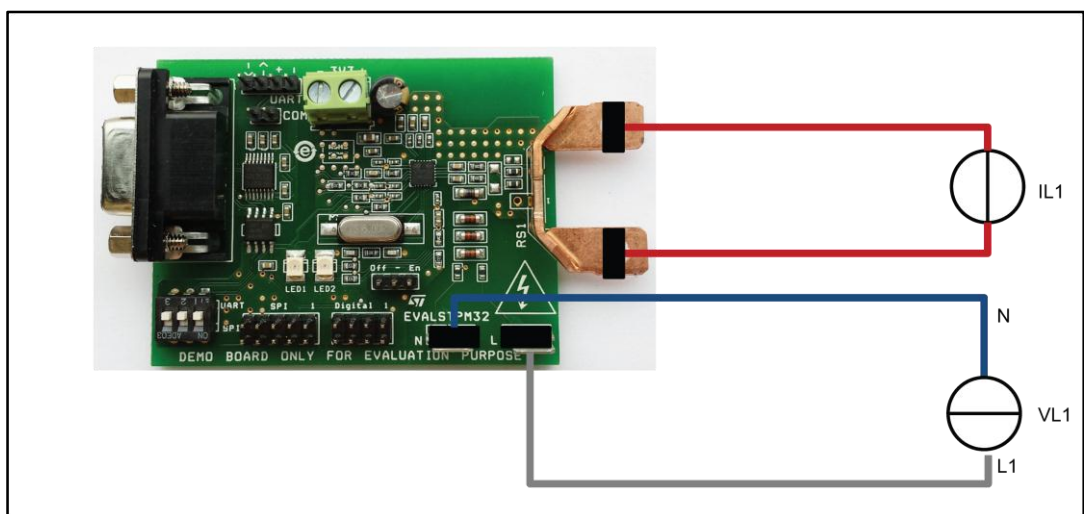

Figure 7: Board connection to isolated AC source (STPM34 and STPM33)

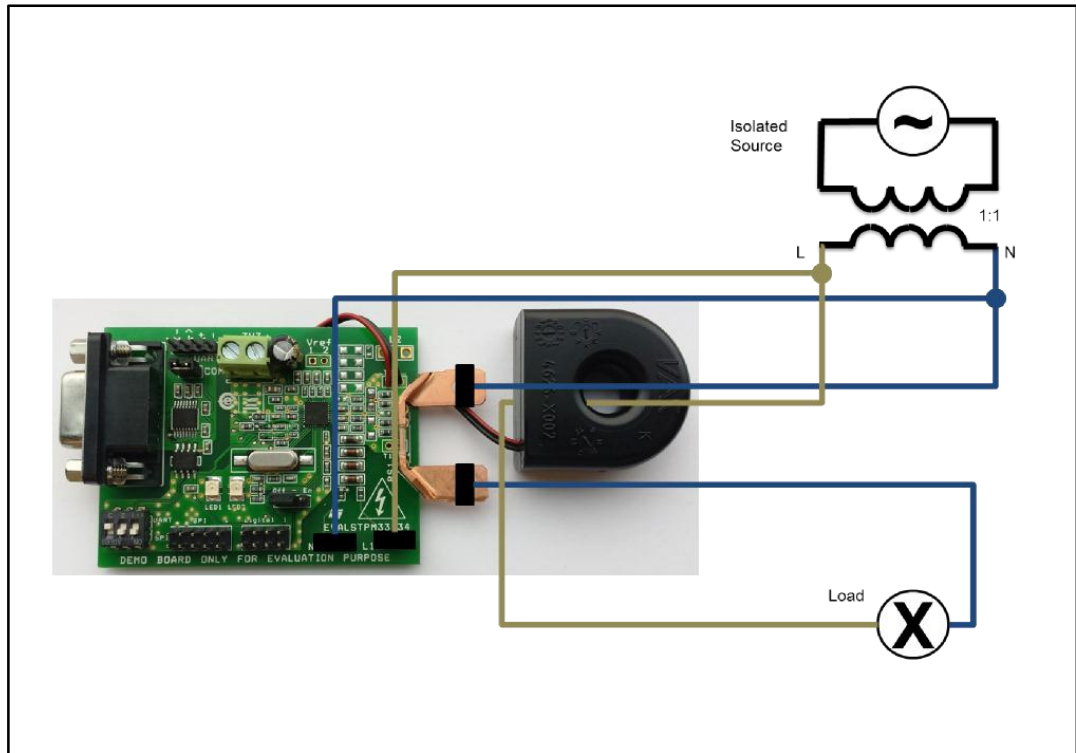
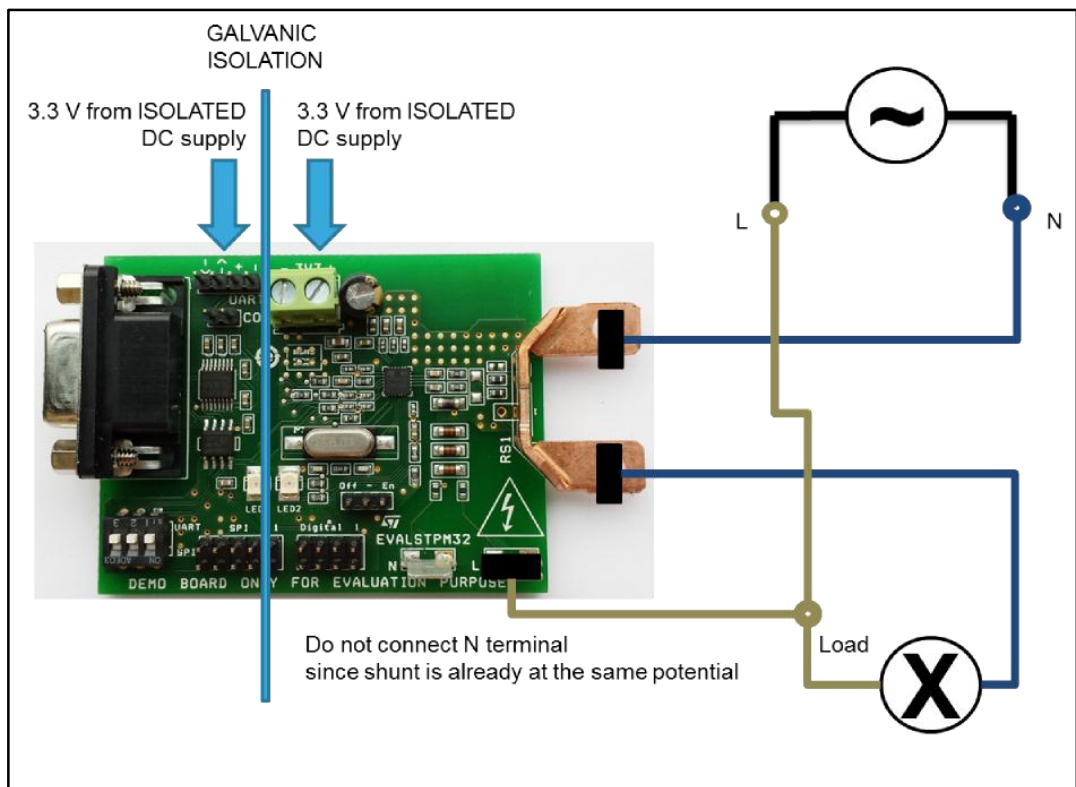

Figure 8: Board connection to mains



## 2.3 Board setup

Regarding to the STPM3x evaluation software setup and use, please refer to user manual UM1719.

The STEVAL-IPE023V1 is not included in the package, therefore it should be ordered separately. Please read the user manual, before using it.

### 2.3.1 Connection to PC GUI through the STEVAL-IPE023V1

To evaluate the board using the STEVAL-IPE023V1 and the STPM3x evaluation software:

1. Put J4 enable jumper in EN position
2. Put SWC1 switches in OFF position, to "SPI serigraphy"
3. Connect J7 connector to 3.3 V DC isolated power supply, or put J4 jumper in the STEVAL-IPE023V1 board in 1-2 position (supply voltage set to 3.3 V)
4. Connect the EVALSTPM3x board to either AC line or power source or phantom load as shown in [Section 2.1: "Board description"](#), without powering it on
5. Connect the USB cable both to the STEVAL-IPE023V1 board and to PC
6. Connect the flat SPI cable from USB board to the EVALSTPM3x board
7. Power on AC source and DC source
8. Open GUI
9. When green LED on the STEVAL-IPE023V1 starts blinking, click "options", then "interface", select "USB" and select the proper "serial port", baud rate is 19200
10. Now you can read, write, sample or calibrate the device

### 2.3.2 Connection to PC GUI through the RS232 port

To evaluate the board using a PC RS232 port and the STPM3x evaluation software:

1. Put J4 enable jumper in EN position
2. Put SWC1 switches in ON position, to "UART" serigraphy
3. Connect J7 connector and J2 connectors to 3.3 V DC separated and isolated power supply
4. Enable RS232 port by inserting J3 jumper
5. Connect the EVALSTPM3x board to either AC line or power source or phantom load as shown in [Section 2.1: "Board description"](#), without powering it on
6. Connect the serial cable both to the board and to PC
7. Power on AC source and DC source
8. Open GUI
9. Click "options", then "interface", select "UART" and select the proper "serial port", baud rate is 9600
10. Now you can read, write, sample or calibrate the device

---

## 2.4 The device basic configuration

During the startup, all internal device parameters are in the default value. For the EVALSTPM34 board, primary channel gain GAIN[1:0] has to be changed to value 0 (current gain = x2), a correct energy measurement is, in this manner, assured. All other parameters can be changed according to the needs (board calibration, phase-shift compensation, desired output on the programmable pin). For further information on the device configuration, please refer to the STPM3x datasheet.

### 3 Revision history

**Table 7: Document revision history**

Date	Revision	Changes
16-Apr-2014	1	Initial release.
30-Sep-2015	2	Updated recommended readings, power supply, board setup and the device basic configuration section. Removed the schematic section. Changed figure titled "Board connection to phantom load, single-phase system (STPM3x)" and figure titled "Board connection to isolated AC source (STPM34 and STPM33)". Added figure titled "Board connection to mains".

**IMPORTANT NOTICE – PLEASE READ CAREFULLY**

STMicroelectronics NV and its subsidiaries ("ST") reserve the right to make changes, corrections, enhancements, modifications, and improvements to ST products and/or to this document at any time without notice. Purchasers should obtain the latest relevant information on ST products before placing orders. ST products are sold pursuant to ST's terms and conditions of sale in place at the time of order acknowledgement.

Purchasers are solely responsible for the choice, selection, and use of ST products and ST assumes no liability for application assistance or the design of Purchasers' products.

No license, express or implied, to any intellectual property right is granted by ST herein.

Resale of ST products with provisions different from the information set forth herein shall void any warranty granted by ST for such product.

ST and the ST logo are trademarks of ST. All other product or service names are the property of their respective owners.

Information in this document supersedes and replaces information previously supplied in any prior versions of this document.

© 2015 STMicroelectronics – All rights reserved