

**SPECIFICATIONS:**

**ELECTRICAL:**  
 INSULATOR RESISTANCE: 5,000 MegOHMS Min.  
 DIELECTRIC WITHSTANDING: 1,000VAC r.m.s.  
 OPERATING TEMPERATURE: -55° C ~ +125° C  
 CONTACT RESISTANCE: 30 MilliOHMS Max.  
 POWER PINS: 40 AMPS  
 SIGNAL PINS: 5 AMPS

**MECHANICAL:**  
 CONTACT INSERTION FORCE: 4.5 Kg Max.  
 CONTACT SEPARATOR FORCE: 0.3Kg Min.

**MATERIALS:**  
 CONTACTS: BRASS  
 INSULATOR: PBT UL94V-0 RATED, 230°C PROCESS TEMP.  
 SHELL: STEEL  
 BOARD LOCK: BRASS, NICKEL PLATED  
 CINCHNUT: BRASS, NICKEL PLATED  
 BRACKET: STEEL, NICKEL PLATED  
 SEALING MATERIAL: F08 FLEXIBLE ADHESIVE

**FINISH:**  
 SHELL: NICKEL  
 CONTACTS: FULL GOLD FLASH

**684S17W2103L461**

46 = 4-40 INSERTS / BOARD LOCKS

**MEETS IP67 STANDARDS**  
 (SEE PAGE 3 FOR SEALING DETAILS)

**RoHS COMPLIANT**

	THESE DRAWINGS AND SPECIFICATIONS ARE THE PROPERTY OF NorComp AND SHALL NOT BE REPRODUCED, COPIED OR USED AS THE BASIS FOR THE MANUFACTURE OR SALE OF APPARATUS WITHOUT WRITTEN PERMISSION.		DRAWN: <b>M. SIGMON</b>	DATE: <b>05-22-12</b>
			CHECKED:	DATE:
<b>NorComp</b>	SCALE: <b>1.5 = 1</b>	SHEET <b>1</b> OF <b>3</b>	REV <b>2</b>	
	DWG NO. <b>684S17W2103L461</b>			

**NOTE:  
POWER CONTACTS COME  
PRE-LOADED INTO INSULATORS**

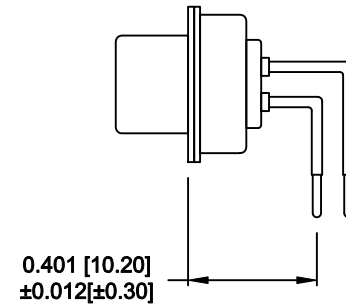
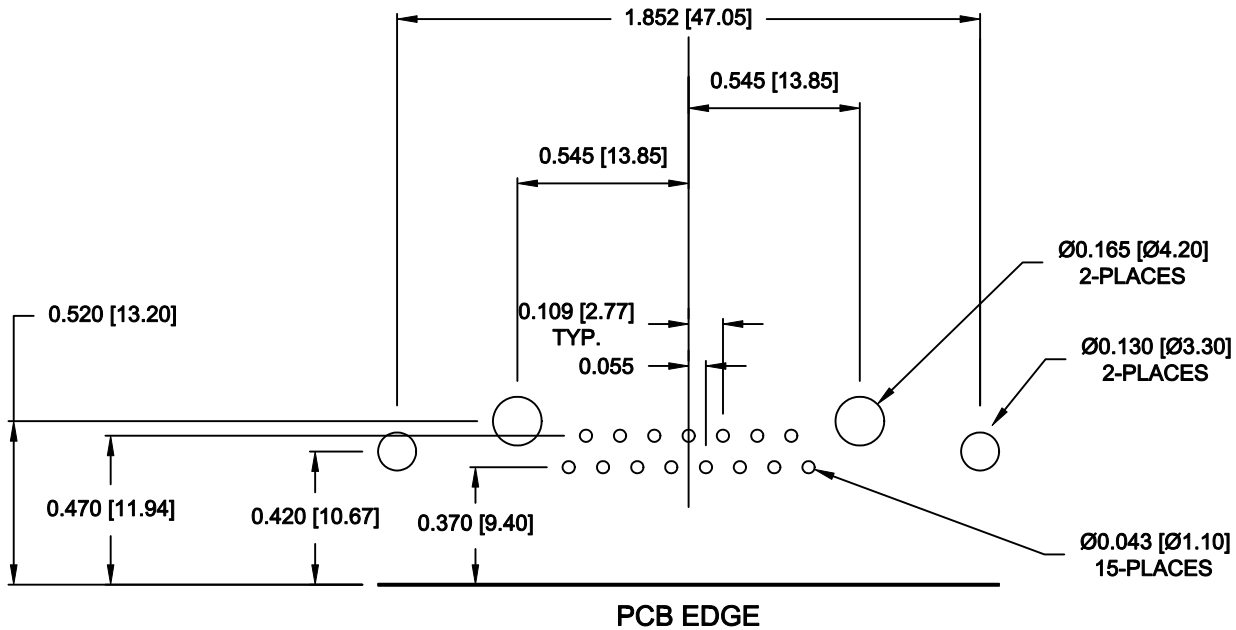

**SIGNAL CONTACTS**

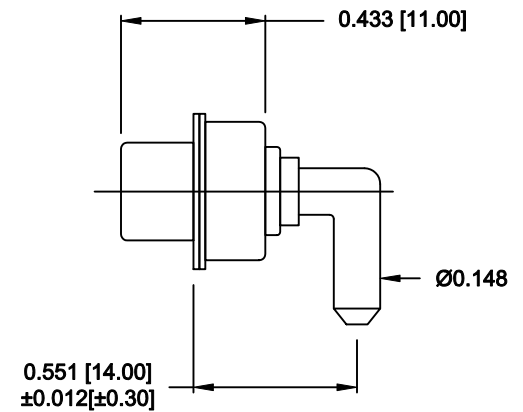

**40 AMP POWER CONTACT**

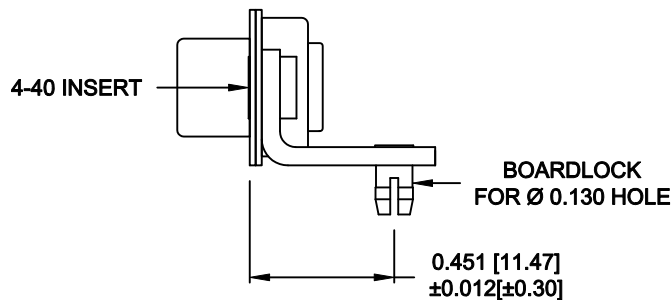

**MOUNTING HARDWARE**

**RoHS COMPLIANT**

	THESE DRAWINGS AND SPECIFICATIONS ARE THE PROPERTY OF NorComp AND SHALL NOT BE REPRODUCED, COPIED OR USED AS THE BASIS FOR THE MANUFACTURE OR SALE OF APPARATUS WITHOUT WRITTEN PERMISSION.		DRAWN: <b>M. SIGMON</b>	DATE: <b>05-22-12</b>
			CHECKED:	DATE:
<b>NorComp</b>		SCALE: <b>1.5 = 1</b>	SHEET <b>2</b> OF <b>3</b>	REV <b>2</b>
		DWG NO. <b>684S17W2103L461</b>		

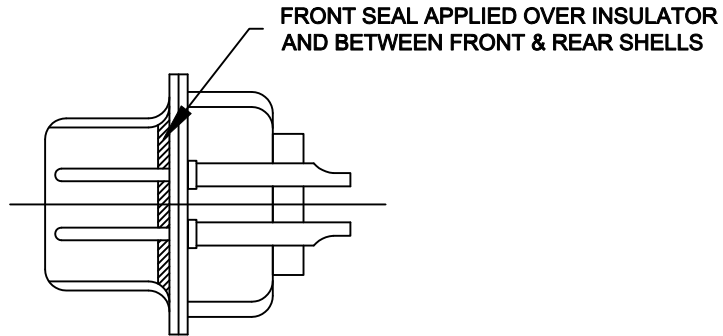
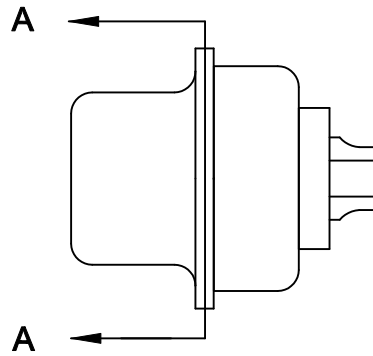

DETAIL A-A  
SHOWN FOR REFERENCE ONLY

	THESE DRAWINGS AND SPECIFICATIONS ARE THE PROPERTY OF NorComp AND SHALL NOT BE REPRODUCED, COPIED OR USED AS THE BASIS FOR THE MANUFACTURE OR SALE OF APPARATUS WITHOUT WRITTEN PERMISSION.		DRAWN: <b>M. SIGMON</b>	DATE: <b>05-22-12</b>	
			CHECKED:	DATE:	
<h1>NorComp</h1>			SCALE: <b>1.5 = 1</b>	SHEET <b>3</b> OF <b>3</b>	REV <b>2</b>
			DWG NO. <b>684S17W2103L461</b>		