

4

3

2

1

THIS DRAWING IS UNPUBLISHED. RELEASED FOR PUBLICATION 2010

© COPYRIGHT 2010 BY TYCO ELECTRONICS CORPORATION. ALL RIGHTS RESERVED.

LOC	DIST	REVISIONS			
P	LTR	DESCRIPTION	DATE	DWN	APVD
E	B	BA	NEW RELEASE	23-MAR-10	MRS St.P

FOR FURTHER INFORMATION SEE DATA SHEET FOR SERIES LR, METAL FILM FIXED RESISTORS

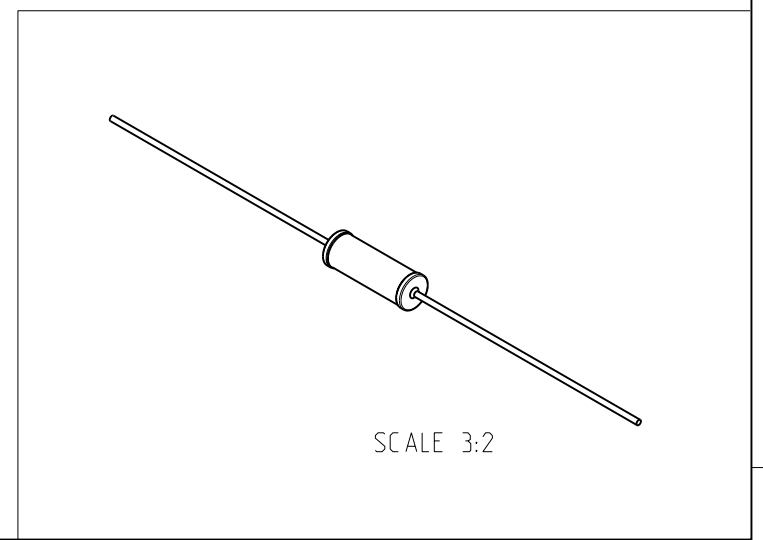
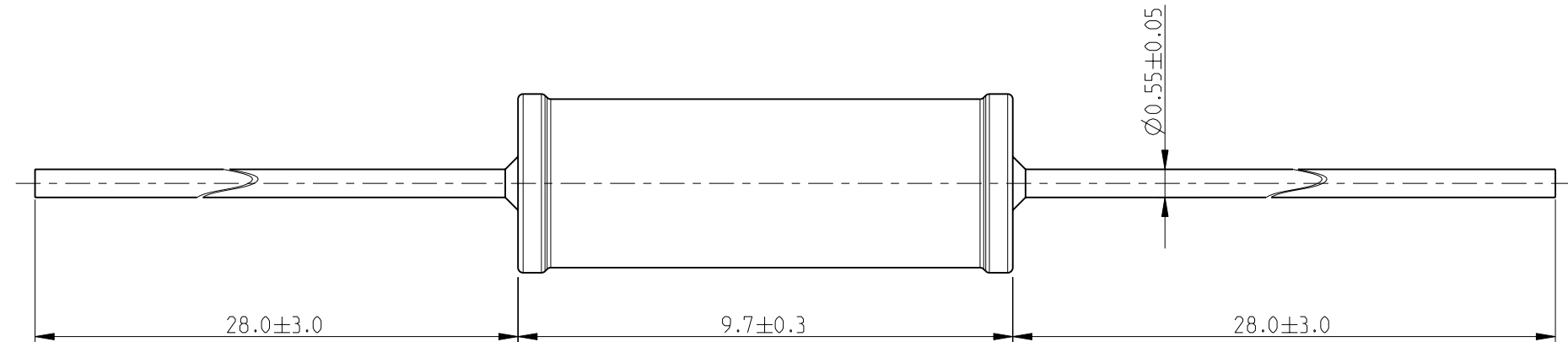

RoHS Compliant

<small>THIS DRAWING IS A CONTROLLED DOCUMENT FOR TYCO ELECTRONICS CORPORATION IT IS SUBJECT TO CHANGE AND THE CONTROLLING ENGINEERING ORGANIZATION SHOULD BE CONTACTED FOR THE LATEST REVISION.</small>		DWN MAHARUDRA 23-MAR-10 CHK ALLAN.P 23-MAR-10 APVD STEPHEN.P 23-MAR-10	Tyco Electronics Corporation Dorcan, Swindon, SN3 5HH
DIMENSIONS: mm	TOLERANCES UNLESS OTHERWISE SPECIFIED: 0 PLC ± 0.2 1 PLC ± 0.1 2 PLC ± - 3 PLC ± - 4 PLC ± - ANGLES ± 5°	PRODUCT SPEC - APPLICATION SPEC - WEIGHT -	NAME METAL FILM FIXED RESISTORS SERIES LR2 SIZE A3 CAGE CODE 00779 DRAWING NO C-1622672 RESTRICTED TO -
MATERIAL -	FINISH -	CUSTOMER DRAWING SCALE 8:1 SHEET 1 OF 1 REV BA	