

IB IL PWM/2 (-PAC)

Inline Function Terminal for Pulse Width Modulation and Frequency Modulation

AUTOMATIONWORX

Data Sheet
6920_en_01

© PHOENIX CONTACT - 03/2007

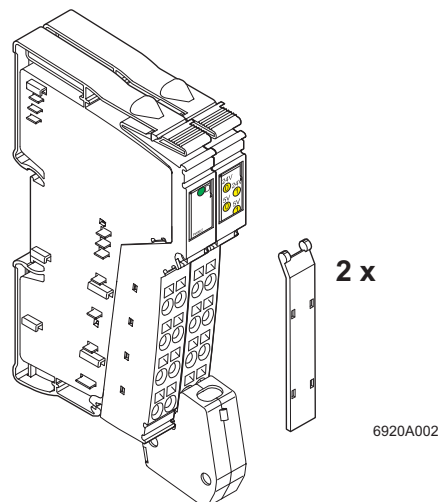

1 Description

The terminal is designed for use within an Inline station. It can be used in four different operating modes:

- PWM (pulse width modulation)
- Frequency generator
- Single shot (single pulse generator)
- Pulse direction signal

Features

- Two channels that operate independently
- Output signals as 5 V or 24 V signals
- Two digital outputs, 5 V DC, 10 mA, 0 Hz to 50 kHz, with an ohmic load capacity, for the connection of high-resistance non-inductive input circuits (e.g., solid-state relays)
- Two digital outputs, 24 V DC, 500 mA, 0 Hz to 500 Hz, with an ohmic and inductive load capacity, suitable for the direct control of loads
- Short-circuit and overload protected outputs



This data sheet is only valid in association with the IL SYS INST UM E user manual or the Inline system manual for your bus system.



Make sure you always use the latest documentation. It can be downloaded at www.download.phoenixcontact.com.
A conversion table is available on the Internet at www.download.phoenixcontact.com/general/7000_en_00.pdf.



This data sheet is valid for the products listed on page 3.

Table of Contents

1	Description.....	1
2	Ordering Data.....	3
3	Technical Data.....	3
4	Local Diagnostic and Status Indicators and Terminal Point Assignment	6
4.1	Local Diagnostic and Status Indicators	6
4.2	Function Identification	6
4.3	Terminal Point Assignment	6
5	Internal Circuit Diagram.....	7
6	Terms and Abbreviations Used	8
7	Overview of the Operating Modes	8
7.1	PWM (Pulse Width Modulation) With Variable Duty Cycle	8
7.2	Frequency Generator With Constant Duty Cycle	8
7.3	Single Shot (Single Pulse Generator)	8
7.4	Pulse Direction Signal.....	8
7.5	Selecting the Operating Mode.....	8
7.6	Changing the Operating Mode.....	8
8	Special Features of the Terminal	9
9	Process Data	9
9.1	OUT Process Data	10
9.2	IN Process Data	10
10	Output Word in General.....	11
11	Reading the Firmware Version and Module ID.....	11
12	PWM (Pulse Width Modulation) Mode.....	12
13	Frequency Generator Mode	14
14	Single Shot (Single Pulse Generator) Mode.....	16
15	Pulse Direction Signal Mode	19
16	Connection Example	22
17	Programming Data/Configuration Data.....	22
17.1	Local Bus (INTERBUS).....	22
17.2	Other Bus Systems	22

2 Ordering Data

Products

Description	Type	Order No.	Pcs./Pkt.
Inline function terminal for pulse width modulation and frequency modulation; without accessories	IB IL PWM/2	2742612	1
Inline function terminal for pulse width modulation and frequency modulation; complete with accessories (connectors and labeling fields)	IB IL PWM/2-PAC	2861632	1



One of the connectors listed below is needed for the complete fitting of the IB IL PWM/2 terminal.

Accessories

Description	Type	Order No.	Pcs./Pkt.
Connector for digital 1, 2 or 8-channel Inline terminals, without color print	IB IL SCN-8	2726337	10
Connector for analog Inline terminals, with color print	IB IL SCN 6-SHIELD-TWIN	2740245	5

Documentation

Description	Type	Order No.	Pcs./Pkt.
User manual: "Automation Terminals of the Inline Product Range"	IL SYS INST UM E	2698737	1
User manual: "Configuring and Installing the INTERBUS Inline Product Range"	IB IL SYS PRO UM E	2743048	1

3 Technical Data

General Data

Housing dimensions (width x height x depth)	24.4 mm x 120 mm x 71.5 mm
Weight	90 g (without connector), 130 g (with connector)
Operating mode	Process data mode with 2 words
Transmission speed	500 kbps
Connection method for actuators	2 and 3-wire technology
Ambient temperature (operation)	-25°C to +55°C
Ambient temperature (storage/transport)	-25°C to +85°C
Permissible humidity (operation/storage/transport)	10% to 95% according to DIN EN 61131-2
Permissible air pressure (operation/storage/transport)	70 kPa to 106 kPa (up to 3000 m above sea level)
Degree of protection	IP20 according to IEC 60529
Class of protection	Class 3 according to VDE 0106, IEC 60536
Connection data for Inline connector	
Connection type	Spring-cage terminals
Conductor cross-section	0.2 mm ² to 1.5 mm ² (solid or stranded), 24 -16 AWG

Interface

Local bus	Through data routing
-----------	----------------------

Power Consumption

Communications power	7.5 V DC
Current consumption at U _L	130 mA, maximum
Power consumption at U _L	0.98 W, maximum
Segment supply voltage U _S	24 V DC (nominal value)
Nominal current consumption at U _S	1 A

Supply of the Module Electronics and I/O Through Bus Coupler/Power Terminal

Connection method Through potential routing

Digital Outputs

24 V DC

Number	2
Nominal output voltage U_{OUT}	24 V DC
Differential voltage at I_{nom}	≤ 1 V
Nominal current I_{nom} per channel	0.5 A
Tolerance of the nominal current	+10%
Internal resistance	200 m Ω
Protection	Short circuit; overload
Nominal load	
Ohmic	12 W
Lamp	12 W
Inductive	12 VA (1.2 H, 24 Ω)
Signal delay upon power up of:	
Nominal ohmic load	Approximately 80 μ s, typical
Nominal lamp load	30 ms, typical
Nominal inductive load	50 ms (1.2 H, 24 Ω), approximately
Signal delay upon power down of:	
Nominal ohmic load	80 μ s, approximately
Nominal lamp load	100 μ s, approximately
Nominal inductive load	150 ms (1.2 H, 24 Ω), approximately
Switching frequency with:	
Nominal ohmic load	500 Hz, maximum
Nominal lamp load	500 Hz, maximum
Nominal inductive load	0.3 Hz (1.2 H, 12 Ω), maximum
Overload response	Auto restart
Response time in the event of a short circuit	400 ms, approximately
Reverse voltage protection against short pulses	Protected against reverse voltages
Resistance to permanently applied reverse voltages	Protected against reverse voltages within the permissible supply voltage range up to 2 A DC
Resistance to polarity reversal of the supply voltage	Protective elements in the bus coupler or power terminal
Resistance to permanently applied surge voltage	No
Validity of output data after connecting the 24 V supply voltage (power up)	1 ms, typical
Response upon power down	The output follows the supply voltage without delay.
Limitation of the voltage induced on circuit interruption	-25 V, approximately
One-time unsolicited energy	200 mJ
Protective circuit type	Integrated free-wheeling diode for each channel
Overcurrent shutdown	0.7 A, minimum
5 V DC	
Number	2
Nominal output voltage U_{OUT}	5 V DC
Differential voltage for I_{nom}	0.5 V
Nominal current I_{nom} per channel	10 mA
Tolerance of the nominal current	+10%
Internal resistance	50 Ω
Protection	Short circuit; overload
Nominal load	500 Ω
Signal delay upon power up of a nominal ohmic load	2 μ s
Signal delay upon power down of a nominal ohmic load	2 μ s
Switching frequency with ohmic nominal load	50 kHz

Power Dissipation

Formula to Calculate the Power Dissipation of the Electronics

$$P_{TOT} = P_{Bus} + P_{Out5V} + P_{Out24V}$$

$$P_{TOT} = 1 \text{ W} + \sum_{i=1}^n (I_{Li}^2 \times 0.4 \Omega)$$

Where

P_{TOT}	Total power dissipation in the terminal
P_{Bus}	Power dissipation in the terminal without set output
$P_{Out 5V}$	Power dissipation in the terminal through set 5 V outputs; This value is negligible and therefore not included in the calculation.
$P_{Out 24V}$	Power dissipation in the terminal through set 24 V outputs
n	Number of set 24 V outputs ($n = 1$ to 2)
I_{Li}	Load current of output i
i	Continuous index

Power Dissipation of the Housing P_{HOu}

1.2 W, maximum (within the permissible operating temperature)

Safety Equipment

Overload/short circuit in segment circuit	Electronic
Surge voltage	Protective elements of the power terminal
Polarity reversal of the supply voltage	Protective elements in the power terminal; The supply voltage must be protected. The power supply unit should be able to supply 4 times (400%) the nominal current of the fuse.
Reverse voltage of the 24 V output	Protected against reverse voltages within the permissible supply voltage up to 2 A

Electrical Isolation/Isolation of the Voltage Areas



To provide electrical isolation between the logic level and the I/O area, it is necessary to supply the station bus coupler and the terminal via the bus coupler or a power terminal from separate power supply units. Interconnection of the power supply units in the 24 V area is not permitted. (See also user manual.)

Common Potentials

The 24 V main voltage, 24 V segment voltage, and GND have the same potential. FE is a separate potential area.

Separate Potentials in the System Consisting of Bus Coupler/Power Terminal and I/O Terminal

- Test Distance

5 V supply incoming remote bus / 7.5 V supply (bus logic)
5 V supply outgoing remote bus / 7.5 V supply (bus logic)
7.5 V supply (bus logic) / 24 V supply (I/O)
7.5 V supply (bus logic) / 5 V supply (I/O)
24 V supply (I/O) / functional earth ground
5 V supply (I/O) / functional earth ground

- Test Voltage

500 V AC, 50 Hz, 1 min
500 V AC, 50 Hz, 1 min
500 V AC, 50 Hz, 1 min
500 V AC, 50 Hz, 1 min
500 V AC, 50 Hz, 1 min
500 V AC, 50 Hz, 1 min

Error Messages to the Higher-Level Control or Computer System

Short circuit/overload of a 24 V output	Yes
Short circuit/overload of a 5 V output	No
Operating voltage out of range	No

Approvals

For the latest approvals, please visit www.download.phoenixcontact.com.

4 Local Diagnostic and Status Indicators and Terminal Point Assignment

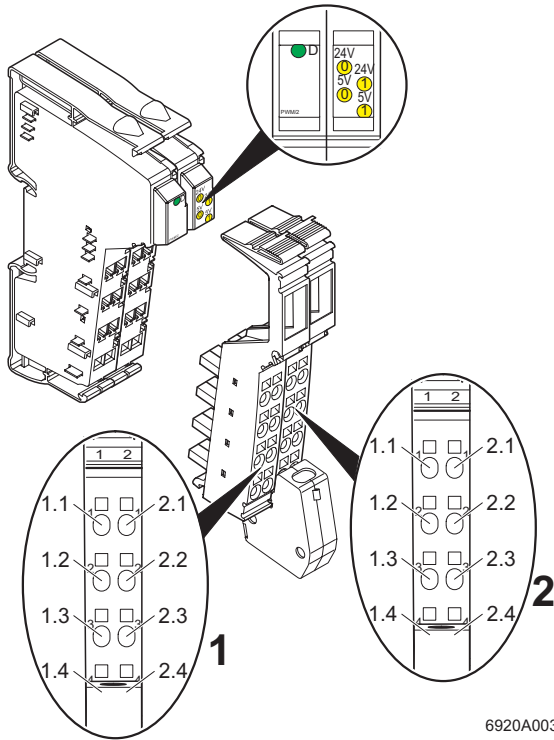

Figure 1 The terminal with associated connectors

6920A003

4.1 Local Diagnostic and Status Indicators

Desig.	Color	Meaning
D	Green	Diagnostics
24V (0)	Yellow	24 V channel 1 active
24V (1)	Yellow	24 V channel 2 active
5V (0)	Yellow	5 V channel 1 active
5V (1)	Yellow	5 V channel 2 active

4.2 Function Identification

Orange

4.3 Terminal Point Assignment

Terminal Point	Assignment
Connector 1	
1.1, 2.1, 1.2, 2.2	Not used
1.3, 2.3	GND for 24 V outputs
1.4, 2.4	FE connection
Connector 2	
1.1	24 V output 1 (DO1)
2.1	24 V output 2 (DO2)
1.2	5 V output 1 (DO1')
2.2	5 V output 2 (DO2')
1.3, 2.3	GND for 5 V outputs
1.4, 2.4	FE connection



Make sure the corresponding ground is connected for the 24 V outputs and the 5 V outputs.

5 Internal Circuit Diagram

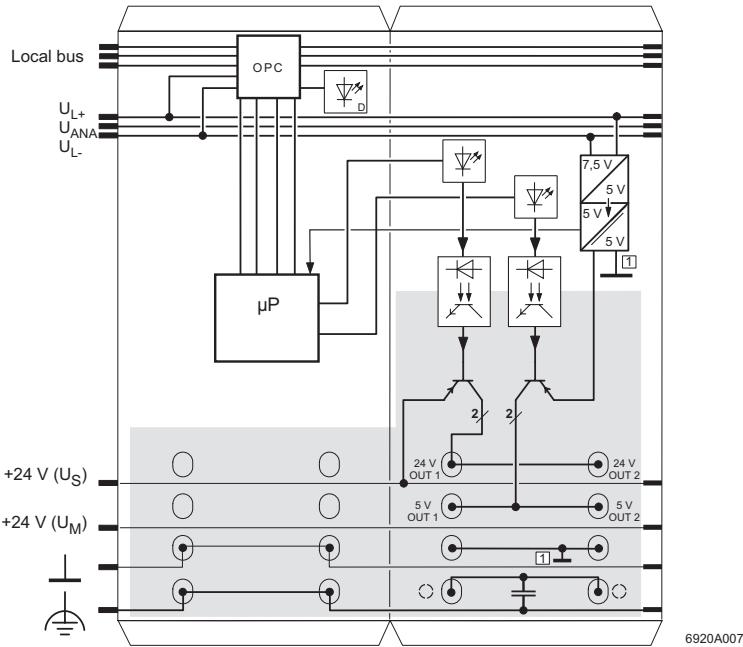











Figure 2 Internal wiring of the terminal points

Key:

-  Protocol chip (bus logic including voltage conditioning)
-  LED
-  Microprocessor
-  DC/DC converter with electrical isolation
-  Optocoupler
-  Transistor
-  Capacitor
-  Ground for 5 V outputs, electrically isolated from ground of the communications power U_L
-  Electrically isolated area



Other symbols used are explained in the IL SYS INST UM E user manual or in the system manual for your bus system.

6 Terms and Abbreviations Used

PWM:	Pulse width modulation
Duty cycle:	High phase of the period
Period:	Duration of the signal to be generated
Single shot:	Single pulse
LSB:	Least significant bit

7 Overview of the Operating Modes

The terminal can be used in four different operating modes:

7.1 PWM (Pulse Width Modulation) With Variable Duty Cycle

This operating mode can be used, for example, to control solid-state relays.
It is suitable for regulating the drive temperature and specifying the drive speed.
This operating mode supports a frequency of up to 10 kHz.

7.2 Frequency Generator With Constant Duty Cycle

This operating mode can be used, for example, to specify the drive speed.
This operating mode supports a frequency of up to 50 kHz.

7.3 Single Shot (Single Pulse Generator)

In this operating mode, single pulses can be generated with a variable duration of between 10 μ s and 25.5 s.
These pulses can be used, for example, to control the opening time of a valve.

7.4 Pulse Direction Signal

This operating mode can be used, for example, to control stepper motors.
A frequency of up to 25 kHz and a target position can be specified.

7.5 Selecting the Operating Mode

The terminal does not require separate parameterization.
The operating mode is selected by sending output words.

A separate operating mode can be selected for each channel except in pulse direction signal mode. When the terminal is operating in pulse direction signal mode, both outputs are required for this mode.

7.6 Changing the Operating Mode



To change mode, disable the active operating mode, before selecting the new mode.

The following parameters stop the relevant operating mode:

PWM:	Duty cycle = 0
Frequency generator:	Frequency = 0
Single shot:	Factor = 0
Pulse direction signal:	Frequency = 0 and Reset bit = 0

8 Special Features of the Terminal

Each of the two output signals is available for one 5 V and one 24 V output.

The 5 V outputs support all frequencies. The 24 V outputs are only operated at up to 500 Hz. At higher frequencies or for pulses that are shorter than 100 µs, the 24 V outputs reset to 0.

Following a bus reset, all outputs are reset and all output activities are stopped.

9 Process Data

The process image of the terminal comprises two data words; one in the input direction and one in the output direction. They may be assigned differently depending on the operating mode.

In **PWM, frequency generator, and single shot** (single pulse generator) mode, each channel occupies one word and operates independently of the other channel. In this case, the process data is assigned as follows:

	Process data word 0	Process data word 1
OUT	Word for output of channel 1	Word for output of channel 2
IN	Word for output of channel 1 mirrored	Word for output of channel 2 mirrored

The "Word for output of channel 1" applies to both the 24 V output of channel 1 and 5 V output of channel 1.

The "Word for output of channel 2" applies to both the 24 V output of channel 2 and 5 V output of channel 2.

In PWM, frequency generator, and single shot (single pulse generator) mode, the output data is mirrored to the input data as long as it is valid. If the output data contains reserved codes and is thus invalid, the data is not mirrored. In this case, the input data contains the last valid values.

In **pulse direction signal** mode, both outputs are controlled together and the terminal operates on a single channel.

Terminal parameterization is not required.

9.1 OUT Process Data

(Word.bit) view	Word	Word 0															
	Bit	15	14	13	12	11	10	9	8	7	6	5	4	3	2	1	0
(Byte.bit) view	Byte	Byte 0								Byte 1							
	Bit	7	6	5	4	3	2	1	0	7	6	5	4	3	2	1	0
OUT[0]	Assignment	See assignment in the individual operating modes															

(Word.bit) view	Word	Word 1															
	Bit	15	14	13	12	11	10	9	8	7	6	5	4	3	2	1	0
(Byte.bit) view	Byte	Byte 2								Byte 3							
	Bit	7	6	5	4	3	2	1	0	7	6	5	4	3	2	1	0
OUT[1]	Assignment	See assignment in the individual operating modes															

9.2 IN Process Data

(Word.bit) view	Word	Word 0															
	Bit	15	14	13	12	11	10	9	8	7	6	5	4	3	2	1	0
(Byte.bit) view	Byte	Byte 0								Byte 1							
	Bit	7	6	5	4	3	2	1	0	7	6	5	4	3	2	1	0
IN[0]	Assignment	See assignment in the individual operating modes															

(Word.bit) view	Word	Word 1															
	Bit	15	14	13	12	11	10	9	8	7	6	5	4	3	2	1	0
(Byte.bit) view	Byte	Byte 2								Byte 3							
	Bit	7	6	5	4	3	2	1	0	7	6	5	4	3	2	1	0
IN[1]	Assignment	See assignment in the individual operating modes															

10 Output Word in General

The operating mode is specified in bits 15 to 13 of the output word for each channel. The assignment of other bits depends on the operating mode.

15	14	13	12	11	10	9	8	7	6	5	4	3	2	1	0
Operating mode															

Code (bin)	Code (hex) (With Bit 12 = 0)	Operating Mode
000	0	Reserved
001	2	Reserved
010	4	PWM mode
011	6	Frequency generator mode
100	8	Single shot (single pulse generator) mode
101	A	Pulse direction signal mode
110	C	Reserved
111	E	Reserved

11 Reading the Firmware Version and Module ID

Only output word 0 is used to read the firmware version and module ID of the terminal.

Output word 0

Bit	15	14	13	12	11	10	9	8	7	6	5	4	3	2	1	0
bin	0	0	1	1	1	1	0	0	0	0	0	0	0	0	0	0
hex	3			C				0				0				

Input word 0: Acknowledgment of the output word

Bit	15	14	13	12	11	10	9	8	7	6	5	4	3	2	1	0
bin	0	0	1	1	1	1	0	0	0	0	0	0	0	0	0	0
hex	3			C				0				0				

Input word 1: Firmware version (e.g., version 1.23) and module ID (5 for PWM/2 module)

Bit	15	14	13	12	11	10	9	8	7	6	5	4	3	2	1	0
bin	0	0	0	1	0	0	1	0	0	0	1	1	0	1	0	1
hex	1			2				3				5				

12 PWM (Pulse Width Modulation) Mode

This operating mode is used to specify a pulse/pause ratio in a period. At a set frequency (as a result of specifying the period length), specify the changing duty cycle. Continuous pulses are generated.

A period length of between 100 µs and 10 s can be specified. This covers a frequency range of 10 kHz to 0.1 Hz. The selected duty cycle can be between 0.39% and 99.45%.

PWM mode can be used, for example, to control solid-state relays. It is suitable for regulating the drive temperature and specifying the drive speed.

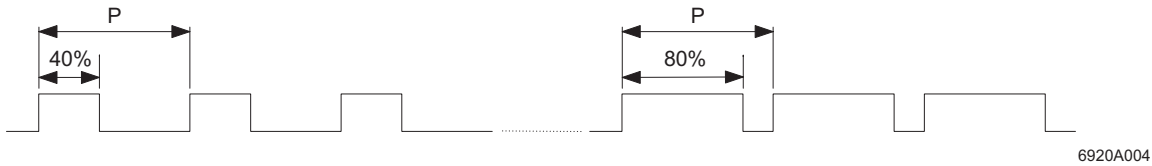

Figure 3 PWM with constant period (P) and variable duty cycle of 40% or 80%

PWM mode can be selected for one channel or both channels. The corresponding output word has the following structure:

Output word

Bit	15	14	13	12	11	10	9	8	7	6	5	4	3	2	1	0
bin	0	1	0	Period length (5 bits)					Duty cycle in 0.39% per LSB (8 bits)							
	High byte (HB)															

The corresponding input word contains the mirrored values of the output word.

The table below contains all the possible values for the **period length**. The high byte (HB) is listed for additional information. It consists of the **operating mode and period length**.

HB (hex)	Period (µs)	Frequency (kHz)	HB (hex)	Period (ms)	Frequency (Hz)	HB (hex)	Period (ms)	Frequency (Hz)	HB (hex)	Period (s)	Frequency (Hz)
40	100	10	45	1	1000	4D	60	16.7	54	1	1
41	200	5	46	2	500	4E	80	12.5	55	2	0.5
42	400	2.5	47	4	250	4F	100	10	56	4	0.25
43	600	1.67	48	6	167	50	200	5	57	6	0.167
44	800	1.25	49	8	125	51	400	2.5	58	8	0.125
			4A	10	100	52	600	1.67	59	10	0.1
			4B	20	50	53	800	1.25			
			4C	40	25						

Duty Cycle

The duty cycle has a value range from 0 (0_{hex}) to 255 (FF_{hex}) at a resolution of 0.39% per LSB.

Value 0 stops the PWM function.

The values 1 to 255 correspond to 0.39% to 99.45% of the period.



The minimum duty cycle (high phase of the period) must be at least 40 µs, the minimum low phase of the period must be at least 80 µs.

The minimum low phase of the period at the 24 V output depends on the load:

Load Resistance R _L	Minimum Low Phase of the Period
< 1 kΩ	80 µs
< 10 kΩ	200 µs
> 10 kΩ	250 µs

Example:

A signal is to be generated with the following properties:

- Period length = 200 ms (frequency = 1/period length = 1/200 ms = 5 Hz)
- Duty cycle = 40%

The code for the operating mode and period length is determined using the table and is 50_{hex}.

The code for the duty cycle is determined as follows:

Code = 40%/0.39% = 102.564; 103 = 1100111_{bin} = 67_{hex}

The value of exactly 40% cannot be mapped. Either 40.17% (67_{hex}) or 39.78% (66_{hex}) is used.

Output word for the example

Bit	15	14	13	12	11	10	9	8	7	6	5	4	3	2	1	0
bin	0	1	0	Period length (5 bits)					Duty cycle in 0.39% per LSB (8 bits)							
bin	0	1	0	1	0	0	0	0	0	1	1	0	0	1	1	1
hex	5			0					6				7			

Further Examples for Different Periods and Different Duty Cycles:

Period Length	HB	Duty Cycle			Output Word
(According to Table on page 12)		(%)	Code (dec)	Code (hex)	(hex)
400 µs	42	0.39	01	01	4201
10 ms	4A	5.07	13	0D	4A0D
60 ms	4D	10.14	26	1A	4D1A
600 ms	52	19.89	51	33	5233
1 s	54	24.96	64	40	5440
10 s	59	49.92	128	80	5980
200 µs	41	74.88	192	C0	41C0
100 ms	4F	99.45	255	FF	4FFF

13 Frequency Generator Mode

This mode is used to specify a variable frequency for a constant duty cycle of 50%. Continuous pulses are generated. Frequencies from 12.21 Hz to 50 kHz can be specified at a resolution of 12.21 Hz per LSB.



The 24 V output switches to 0 at a frequency > 500 Hz.

This operating mode can be used, for example, to specify the drive speed.

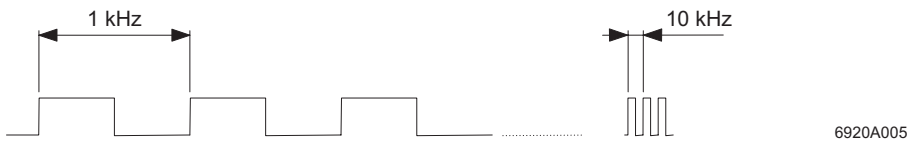

Figure 4 Frequency generator

Frequency generator mode can be selected for one channel or both channels. The corresponding output word has the following structure:

Output word

Bit	15	14	13	12	11	10	9	8	7	6	5	4	3	2	1	0
bin	0	1	1	Res.	Frequency in 12.21 Hz per LSB (12 bits)											

Res. = Reserved (= 0)

The corresponding input word contains the mirrored values of the output word.

Example:

A signal with a frequency of 10 kHz is to be generated.



This frequency is only supported with a 5 V output.

The code for the frequency is determined as follows:

Code = 10 kHz/12.21 Hz = 819 = 0011 0011 0011_{bin} = 333_{hex}

Output word for the example

Bit	15	14	13	12	11	10	9	8	7	6	5	4	3	2	1	0
bin	0	1	1	Res.	Frequency in 12.21 Hz per LSB (12 bits)											
bin	0	1	1	0	0	0	1	1	0	0	1	1	0	0	1	1
hex	6			3			3			3						

Further Examples:

Frequency		Output Word (hex)
Hz	Code (dec)	
12.21	01	6001
24.42	02	6002
48.84	04	6004
97.68	08	6008
244.20	20	6014
500.61	41	6029

Frequency		Output Word (hex)
kHz	Code (dec)	
1	82	6052
10	819	6333
20	1638	6666
30	2457	6999
40	3276	6CCC
50	4095	6FFF

14 Single Shot (Single Pulse Generator) Mode

In this operating mode, the terminal outputs a single pulse at the output for the specified time. A pulse length of between 10 μs and 25.5 s can be specified.

These pulses can be used, for example, to control the opening time of a valve.

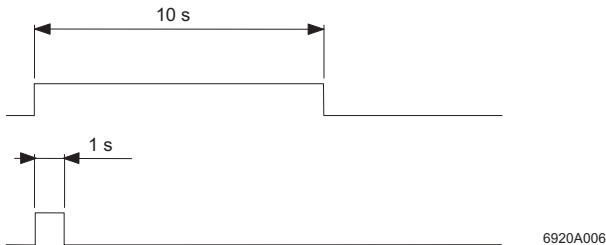

Figure 5 Two single shots with different length

Pulse Length

To set the pulse length, specify a time base and a factor.

$$\text{Pulse length} = \text{time base} \times \text{factor}$$

Single shot mode can be selected for one channel or both channels. The corresponding output word has the following structure:

Output word

Bit	15	14	13	12	11	10	9	8	7	6	5	4	3	2	1	0
bin	1	0	0	Res.		Time base			Factor (8 bits)							

Res. = Reserved (= 0)

The corresponding input word has the following structure:

Input word

Bit	15	14	13	12	11	10	9	8	7	6	5	4	3	2	1	0
bin	1	0	0	Ready	Res.	Time base			Factor (8 bits)							

Time Base

The time base defines the value range of the pulse length.

Code (bin)	Code (hex)	Time Base	Maximum Time	Remark
000	0	10 μs	2.5 ms	Only for 5 V outputs
001	1	100 μs	25.5 ms	
010	2	1 ms	255 ms	
011	3	10 ms	2.5 s	
100	4	100 ms	25.5 s	
Other		Reserved		



The 10 μs time base is disabled for 24 V outputs.



If a value can be represented in different time bases, select the time base that represents the value most precisely (see also "Further Examples" on page 18).

Factor

The factor has a value range from 0_{dec} to 255_{dec} .

The value 0 stops the single shot function.

Ready (Input word)

Value	Meaning
0	Pulse generator has started
1	High phase has finished

Single Shot Sequence

Single shot mode is started by writing the time base and/or factor. The start is indicated in the input word by Ready = 0.

If the high phase has finished, Ready = 1 is set.

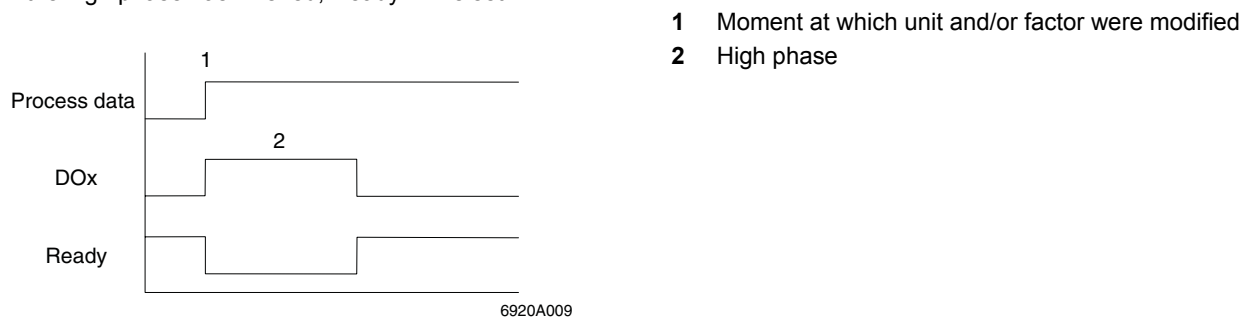

Figure 6 Sequence for generating a pulse after specifying a unit and/or factor

A new pulse is generated when the time base and/or factor is modified.



If the pulse length is modified while a pulse is being output, the active pulse output process is extended by the newly specified time. Therefore only modify the time base and the factor when Ready = 1.

To generate the same pulse several times in succession, proceed as follows after each pulse generation:

- Wait until Ready = 1
(high phase of the pulse has finished)
- Set factor to 0
- Wait for confirmation by reading the input word (factor = 0)
- Set the factor to the desired value



Starting the pulse generator while Ready = 0 (i.e., before the previously started single shot has finished) acts as a retrigger, which means the active pulse is extended by the newly specified time.



Each pulse at the 5 V output has a constant error of 5 μs, each pulse at the 24 V output has a constant error of 100 μs.

Example:

A single shot with a duration of 12 s is to be generated.

- Time base: 100 ms (time base code = 4_{hex})
- Factor: 12 s/100 ms = 120 = 1111000_{bin} = 78_{hex}

Output word for the example

Bit	15	14	13	12	11	10	9	8	7	6	5	4	3	2	1	0
bin	1	0	0	Res.			Time base			Factor (8 bits)						
bin	1	0	0	0	0	1	0	0	0	1	1	1	1	0	0	0
hex	8			4				7				8				

Further Examples

Time Base	10 µs (5 V Only)		100 µs		1 ms		10 ms		100 ms	
Length of Single Shot	Factor (dec)	OUT (hex)	Factor (dec)	OUT (hex)	Factor (dec)	OUT (hex)	Factor (dec)	OUT (hex)	Factor (dec)	OUT (hex)
50 µs	5	8005								
100 µs	10	800A	1	8101						
250 µs	25	8019	-	-						
500 µs	50	8032	5	8105						
1 ms	100	8064	10	810A	1	8201				
2.5 ms	250	80FA	20	8114	2	8202				
2.55 ms	255	80FF	-	-	-	-				
5 ms			50	8132	5	8205				
10 ms			100	8164	10	820A	1	8301		
25.5 ms			255	81FF	-	-	-	-		
50 ms					50	8232	5	8305		
100 ms					100	8264	10	830A	1	8401
255 ms					255	82FF	-	-	-	-
500 ms							50	8332	50	8405
1s							100	8364	10	840A
2 s							200	83C8	20	8414
2.5 s							250	83FA	25	8419
10 s									100	8464
25.5 s									255	84FF

OUT = Output word

The gray cells represent values, which **cannot** be represented in this time base as they are outside the permissible value range.

The values indicated with "-" are values, which **cannot be represented precisely** in this time base even though they are within the permissible value range of the time base. Only a rounded value can be represented. To represent the value precisely, select a different time base.

15 Pulse Direction Signal Mode

In this mode, both outputs are used together, which means that only one channel is available. Together with the freely controllable output DO2, this operating mode also represents a pulse direction interface.

Pulse trains, whose frequency can be selected, are output as pulse direction signals. The frequency is evaluated by the connected stepper motor in such a way that each pulse is converted into steps. The motor speed increases in proportion to the frequency, which means that the frequency can be used to influence the speed of the motor. A positioning counter counts the completed steps so that the drive position can also be read.

This operating mode can be used for variable speed drives with no position specifications (target position = FFFF_{hex}). In this case, the position is evaluated by a higher-level control system and the motor is controlled via the higher-level control system.

However, this operating mode can also be used for variable speed drives with position specifications. In this case the Inline terminal stops the motor automatically when the specified target position is reached.

Output words 0 and 1

0											1																				
15	14	13	12	11	10	9	8	7	6	5	4	3	2	1	0	15	14	13	12	11	10	9	8	7	6	5	4	3	2	1	0
1	0	1	RDO2	N	Frequency (11 bits)											Target position (16 bits)															

RDO2	Direction and output DO2	R = 0 (DO2 = 0)	Down or reverse
		R = 1 (DO2 = 1)	Up or forwards
N	Reset	Rising edge	Positioning counter resets to 0000000 _{hex}

Input words 0 and 1

0											1																				
15	14	13	12	11	10	9	8	7	6	5	4	3	2	1	0	15	14	13	12	11	10	9	8	7	6	5	4	3	2	1	0
1	0	1	DO2	R	Res.	Positioning counter (25 bits)																									

DO2	Image of output DO2		
R	Ready	Ready = 0	Pulse output process active
		Ready = 1	Pulse output process completed
Res.	Reserved		

RDO2 (Direction and Output DO2)

This bit controls output DO2 and therefore indirectly controls the counting direction of the positioning counter.

RDO2 = 0: down or reverse
 RDO2 = 1: up or forwards

N (Reset)

On a rising edge of the bit to 1, the positioning counter resets to 0000000_{hex}.

The values N = 1 **and** Frequency = 0 stop the operating mode.

Frequency (11 Bits)

The frequency code has a range from 0 Hz to 25 kHz, which provides a resolution of 12.21 Hz/LSB. The duty cycle remains constant at 50%.

The value 0 aborts the active pulse output process. The values N = 1 **and** Frequency = 0 stop the operating mode. Changing the frequency is immediately accepted.

Target Position (16 Bits)

The target position has a value range from 0_{hex} to FFFE_{hex} (0_{dec} to 65534_{dec}).

The value FFFF_{hex} (65535_{dec}) results in an infinite pulse output process. A value between 0_{hex} and FFFE_{hex} stops the pulse output process if the 16 least significant bits of the positioning counter are the same as the target position.

Pulses are output at output DO1. Direction bit RDO2 specifies the counting direction.

DO2 (Image of Output DO2)

This bit indicates the status of output DO2.

R (Ready)

This bit is only active when a finite pulse output process is selected (target position between 0_{hex} and FFFE_{hex}). The Ready bit then indicates whether or not a pulse output process has been completed.

Ready = 0: Pulse output process active
 Ready = 1: Pulse output process completed

The bit is reset when a new pulse output process is started.

Positioning Counter (25 Bits)

The positioning counter counts the previously output pulses either up or down depending on signal RDO2.

Response to Specific Conditions:

Action	Response
Frequency = 0	Pulse output process stops
Frequency modification without target position modification	Ready = 1: No response Ready = 0: Frequency modified during the active pulse output process
Frequency modification with target position modification	Ready = 1: Start new pulse output process Ready = 0: Frequency modified during the active pulse output process
Target position modification	Ready = 1: Start new pulse output process Ready = 0: The old target position is rejected, the pulse output process is continued until the target position is reached
Target position = 0	Normal target position
Target position = FFFF _{hex}	Continuous pulse output process
Rising edge of the Reset bit	Positioning counter is cleared, regardless of Ready value
RDO2 bit	Output DO2 is controlled directly. The counting direction changes on the next pulse output process. When the value of bit RDO2 is modified, but the frequency and target position remain unchanged, there is no response at output 2, i.e., the specified value is not accepted. In the input word, the actual status of output 2 is mirrored in bit DO2, i.e., in this case the value is not identical to the value specified in RDO2.

Example 1:

The required movement is from position 0 to the target position 1B43_{hex}.

The value is approached in a positive direction (forwards), i.e., RDO2 = 1.

The frequency is to be 1 kHz.

Frequency code: 1000 Hz/12.21 kHz = 81.9; 82_{dec} = 52_{hex} = 000 0101 0010_{bin}

Output words 0 and 1

0											1																				
15	14	13	12	11	10	9	8	7	6	5	4	3	2	1	0	15	14	13	12	11	10	9	8	7	6	5	4	3	2	1	0
1	0	1	RDO2	N	Frequency (11 bits)											Target position (16 bits)															
1	0	1	1	0	0	0	0	0	1	0	1	0	0	1	0	0	0	0	1	1	0	1	1	0	1	0	0	0	0	1	1
B			0			5			2		1		B		4		3														

The pulse output process is stopped when the value 1B43_{hex} is reached in input word 1. During the process, 1B43_{hex} = 6979_{dec} pulses were output with a frequency of 1 kHz.

Example 2:

The required movement is to a target position, whose code is greater than the value that can be represented in 16 bits.

Target position = 21 5687_{hex}

RDO2 = 1

Frequency = 10 kHz; 10,000 Hz/12.21 Hz = 819_{dec} = 333_{hex}

– In output word 1 enter the value FFFF_{hex} to select a continuous pulse output process.

Output words 0 and 1

0											1																				
15	14	13	12	11	10	9	8	7	6	5	4	3	2	1	0	15	14	13	12	11	10	9	8	7	6	5	4	3	2	1	0
1	0	1	RDO2	N	Frequency (11 bits)											Target position (16 bits)															
1	0	1	1	0	0	1	1	0	0	1	1	0	0	1	1	1	1	1	1	1	1	1	1	1	1	1	1	1	1	1	1
B			3			3			3		F		F		F		F														

– Monitor the positioning counter in the input words.

As soon as the value B021_{hex} appears in input word 0, specify the four low bytes of target position 5687_{hex} in output word 1.

Input words 0 and 1

0											1																				
15	14	13	12	11	10	9	8	7	6	5	4	3	2	1	0	15	14	13	12	11	10	9	8	7	6	5	4	3	2	1	0
1	0	1	DO2	R	Res.	Positioning counter (25 bits)																									
1	0	1	1	0	0	0	0	0	0	1	0	0	0	0	1	0	0	0	0	0	0	0	0	0	0	0	0	0	0	0	
B			0			2			1		0		0		0		0														

Output words 0 and 1

0											1																				
15	14	13	12	11	10	9	8	7	6	5	4	3	2	1	0	15	14	13	12	11	10	9	8	7	6	5	4	3	2	1	0
B			3			3			3		5		6		8		7														

– The pulse output process is stopped when the value in input word 1 corresponds to the specified target position.

16 Connection Example

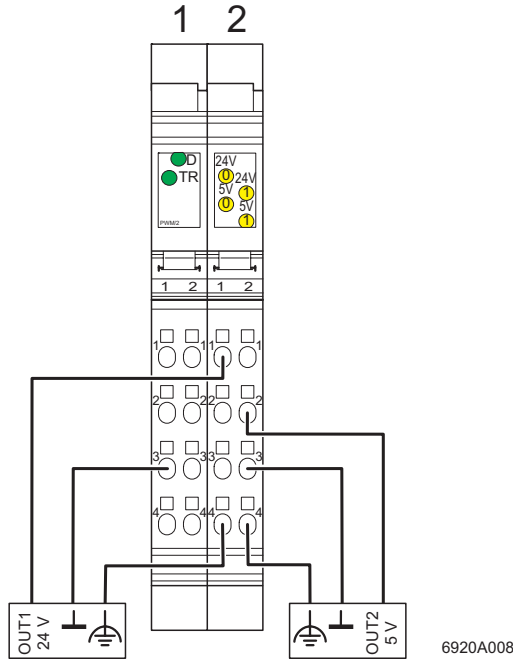

Figure 7 Typical connection of a 24 V actuator and a 5 V actuator (not in pulse direction signal mode)



Use a connector with shield connection when connecting the I/O device. Figure 7 shows the connection schematically (without shield connector).

17 Programming Data/ Configuration Data

17.1 Local Bus (INTERBUS)

ID code	BF _{hex} (191 _{dec})
Length code	02 _{hex}
Process data channel	32 bits
Input address area	2 words
Output address area	2 words
Parameter channel (PCP)	0 bytes
Register length (bus)	2 words

17.2 Other Bus Systems



For the configuration data of other bus systems, please refer to the corresponding electronic device data sheet (e.g., GSD, EDS).

© PHOENIX CONTACT 03/2007