

Surface Mount Ferrite Chip Beads Array

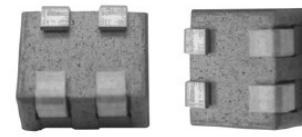

5.60 x 4.80 x 3.00mm

ACSB-05-T



RoHS/RoHS II Compliant

FEATURES:

- Suitable for high density mounting or where board space is at a premium.
- Superior attenuation across a broad frequency range up to GHz range.
- Wide operating temperature range of -40°C to +85°C.
- RoHS Compliant and lead free.

APPLICATIONS:

- Notebooks, Tablets, Smartphones, Cameras, DVD/Blu-ray players, LED TVs, Motherboards, Power Supplies, Modems

STANDARD SPECIFICATIONS:

PARAMETERS

ABRACON P/N:	ACSB-05-T
Operating temperature:	-40°C to +85°C
Storage Temperature and Humidity (In Tape and Reel)	+5°C to +40°C, 60% to 70% RH

Key Electrical Specifications

Impedance	Test Frequency	RDC	IDC
Ω	MHz	m Ω	A Max
23 Ref	25	3	5
35 Ref	100		

Test Conditions

Instrument: Agilent 4294A Precision Impedance Analyzer.

IDC: Based on temperature rise (ΔT : 40°C TYP.)

ELECTRICAL CHARACTERISTIC CURVE

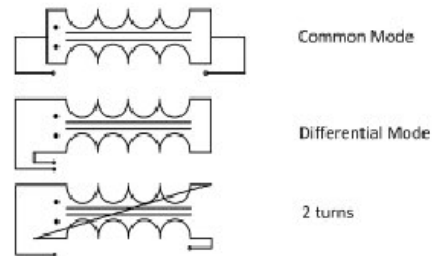
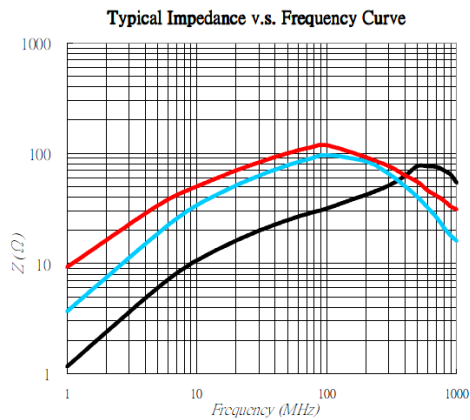

OUTLINE DIMENSIONS:

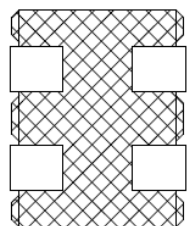
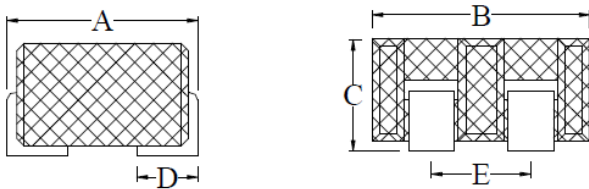

A	B	C Max	D	E
4.80±0.30	5.60±0.20	3.00	1.40±0.15	2.54±0.20*

Recommended Land Pattern

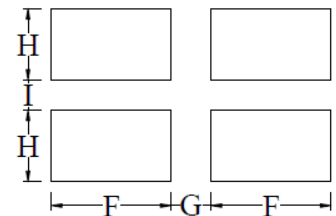

F	G	H	I
3.00 ref.	1.00 ref.	1.80 ref.	0.74 ref.

Dimension: mm

ABRACON IS
ISO 9001:2008
CERTIFIED



Visit www.abracon.com for Terms & Conditions of Sale **Revised: 09.29.13**
30332 Esperanza, Rancho Santa Margarita, California 92688
tel 949-546-8000 | fax 949-546-8001 | www.abracon.com

Surface Mount Ferrite Chip Beads Array

ACSB-05-T

 RoHS/RoHS II Compliant

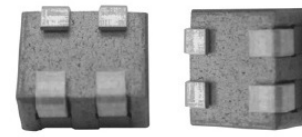

5.60 x 4.80 x 3.00mm

REFLOW PROFILE:

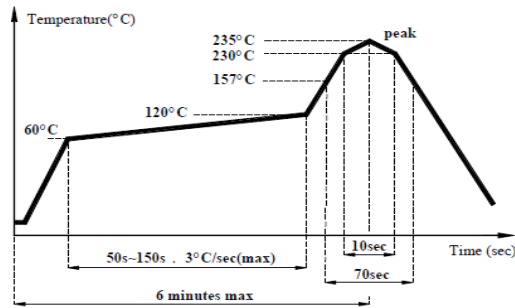

TAPE & REEL:

Packing
T: 2,000pcs / reel

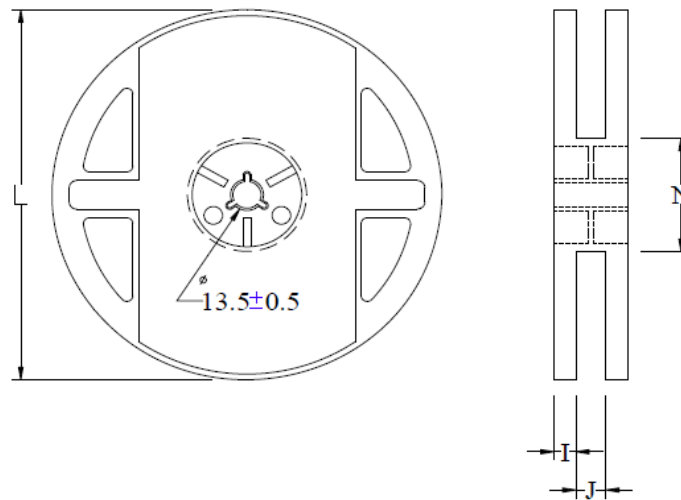
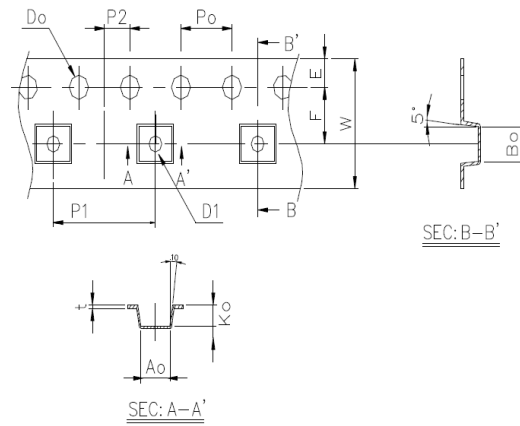

A0	B0	K0	D0	D1	F	P1	W	t	L	I	J	N
6.0 ± 0.1	5.1 ± 0.1	3.2 ± 0.1	1.5 ± 0.1	1.5 ± 0.05	5.5 ± 0.05	8 ± 0.1	12 ± 0.2	0.3 ± 0.05	330	2.3	12	100

Dimension: mm

ATTENTION: Abracon Corporation's products are COTS – Commercial-Off-The-Shelf products; suitable for Commercial, Industrial and, where designated, Automotive Applications. Abracon's products are not specifically designed for Military, Aviation, Aerospace, Life-dependant Medical applications or any application requiring high reliability where component failure could result in loss of life and/or property. For applications requiring high reliability and/or presenting an extreme operating environment, written consent and authorization from Abracon Corporation is required. Please contact Abracon Corporation for more information.

ABRACON IS
ISO 9001:2008
CERTIFIED



Visit www.abracon.com for Terms & Conditions of Sale
30332 Esperanza, Rancho Santa Margarita, California 92688
tel 949-546-8000 | fax 949-546-8001 | www.abracon.com

Revised: 09.29.13