

REV.	DATE	ECR NO.	DESCRIPTION
NC	10/20/10	XXXXXX	INITIAL RELEASE

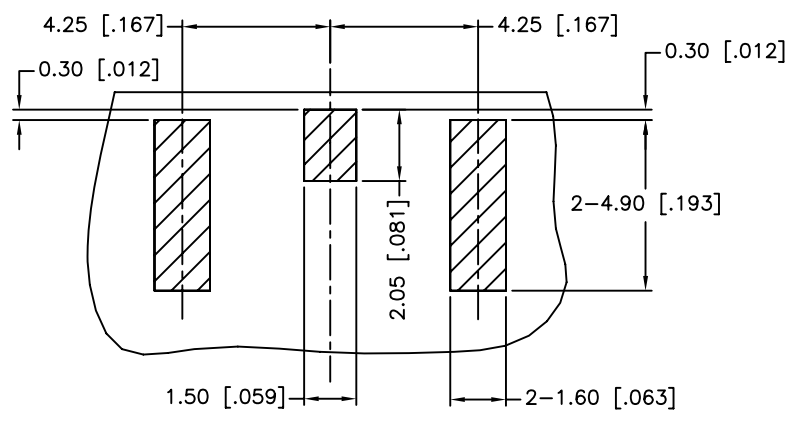

TOP VIEW

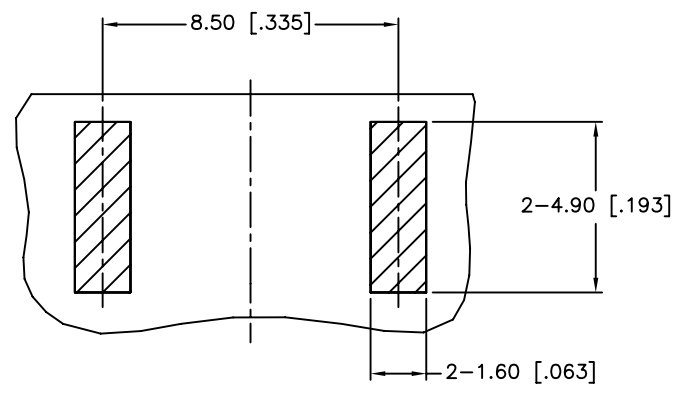

BOTTOM VIEW

RECOMMENDED PCB LAYOUT

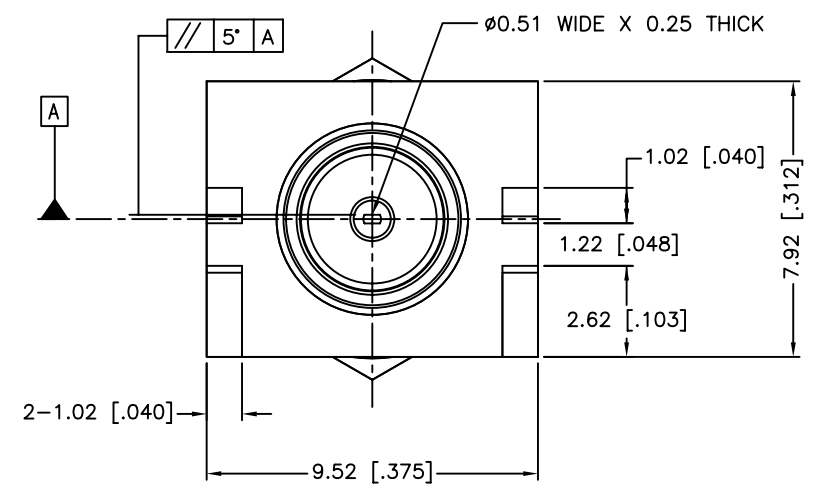
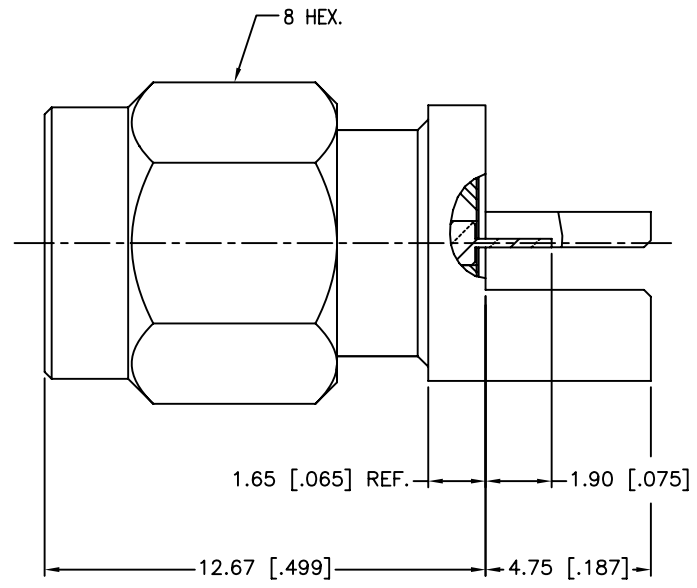

8	RING	BRASS	GOLD	1
7	INSULATOR	PTFE	NATURAL	1
6	BODY	BRASS	GOLD	1
5	INSULATOR	PTFE	NATURAL	1
4	RETAINER RING	SUS 304	NATURAL	1
3	GASKET	SILICONE	RED	1
2	CONTACT PIN	BRASS	GOLD	1
1	SHELL	BRASS	GOLD	1
DESCRIPTION	MATERIAL	FINISH	QTY	

UNLESS OTHERWISE SPECIFIED DIMENSIONS ARE IN MILLIMETERS. DIMENSIONS IN [] ARE IN INCHES AND FOR CUSTOMER REFERENCE ONLY.

UNLESS OTHERWISE SPECIFIED TOLERANCES FOR MILLIMETERS ARE:
0.5 - 8mm ± 0.20mm
8 - 30mm ± 0.40mm
30 - 120mm ± 0.50mm

UNLESS OTHERWISE SPECIFIED TOLERANCES FOR INCHES ARE:
.020 - .315 = ± 0.007"
.315 - 1.180 = ± 0.015"
1.180 - 4.724 = ± 0.020"

DO NOT SCALE DRAWING

APPROVALS	DATE
DRAWN M.ZHANG	10/20/10
CHECKED	
ISSUED	
SHEET 1 OF 1	
CAD FILE C:/CONNEX/132413.DWG	

Amphenol Connex

PART DESCRIPTION
**SMA END LAUNCH RECEPT. PLUG
(FOR .042" BOARD THICKNESS)**

PART NO.
132413

DWG. NO. 132413.DWG REV. B SIZE A SCALE NA