

SPECIFICATIONS

PARAMETERS	VALUES	UNITS
RESONANT FREQUENCY	6,500 ± 500	Hz
RESONANT IMPEDANCE (MAX)	500	Ohm
MAX INPUT VOLTAGE	30	Vp-p
CAPACITANCE @ 1KHZ	14,000 ± 30%	pF
PLATE MATERIAL	BRASS	-
OPERATING TEMPERATURE	-20 ~ +60	°C
STORAGE TEMPERATURE	-30 ~ +70	°C

THIS DOCUMENT CONTAINS DATA PROPRIETARY TO PROJECTS UNLIMITED, INC. ANY USE OR REPRODUCTION, IN ANY FORM, WITHOUT PRIOR WRITTEN PERMISSION OF PROJECTS UNLIMITED, INC. IS PROHIBITED.
©2003, Projects Unlimited Inc.

REVISION HISTORY

LTR	DESCRIPTION	DATE	APPROVED
-	RELEASED FROM ENGINEERING	10/05/2010	
A	REVISED TO INVENTOR 3-D DRAWING TEMPLATE	12/05/2013	M.L.

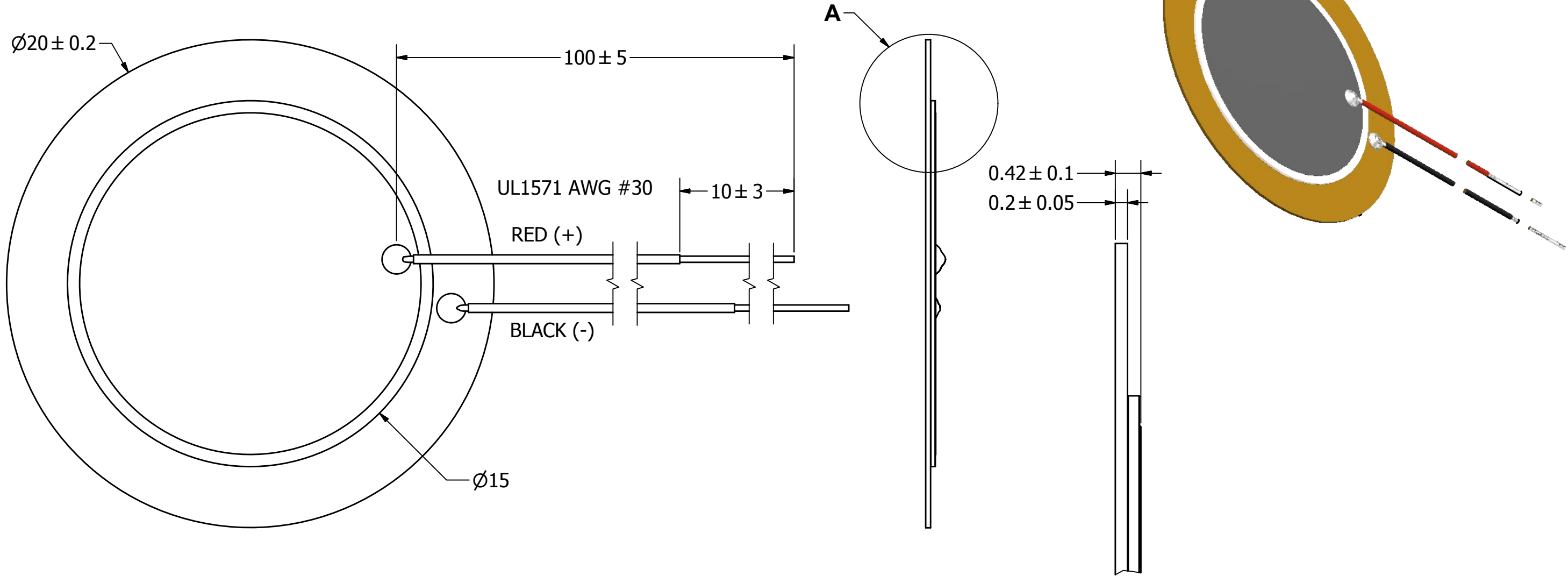

A (15 : 1)

NOTES:

1. ALL DIMENSIONS ARE IN MILLIMETERS.
2. SPECIFICATIONS SUBJECT TO CHANGE OR WITHDRAWL WITHOUT NOTICE.
3. THIS PART IS RoHS 2011/65/EU COMPLIANT.

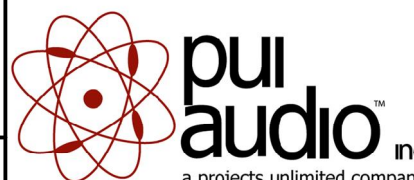
UNLESS OTHERWISE SPECIFIED: DIMENSIONS ARE IN MILLIMETERS, TOLERANCES ARE ± 0.5 AND ANGLES ARE $\pm 3^\circ$.	SIZE A3	Designed by	Date	Checked by	Date	Approved by	Date	Drawn Date
		J.D.	10/5/2010	C.W.	10/5/2010	B.R.	10/5/2010	10/5/2010
AB2065B-LW100-R.idw					AB2065B-LW100-R			
		Bender			Edition	Sheet		
					-	1 / 1		