

L69911RS
(ON DRAWING)台異異図

版数 VER.	年月日 DATE	CN NO.	変更内容 DESCRIPTION	製図 DR.	担当 CHK.	査閲 APPD.	承認 APPD.
------------	-------------	--------	---------------------	-----------	------------	-------------	-------------

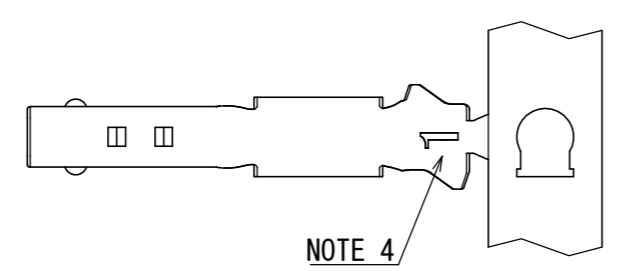
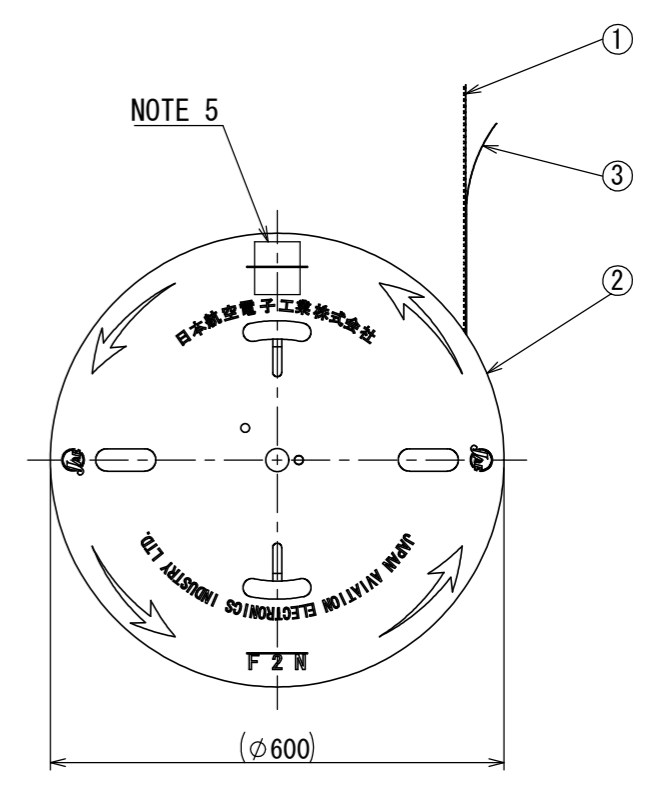
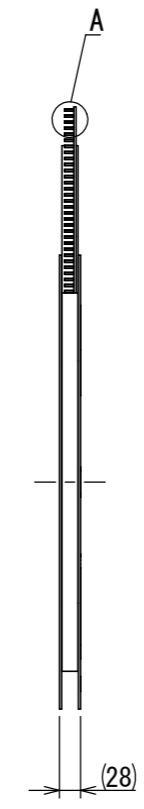
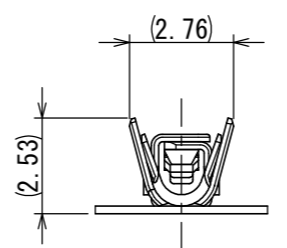
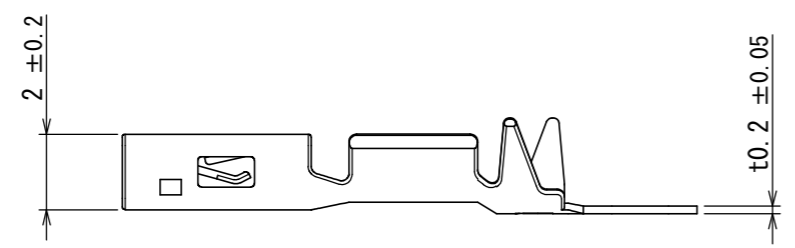
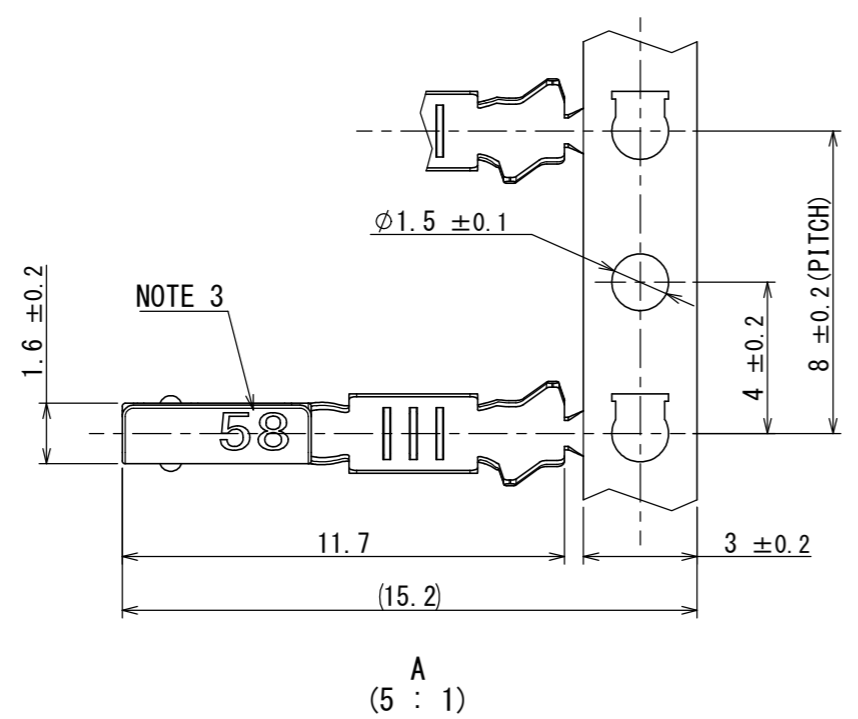

NOTE 1. THESE CONTACTS ARE SUPPLIED IN REEL. THERE ARE 6000 CONTACTS PER REEL.
 NOTE 2. APPLICABLE CABLE: AWG#22 TO #24, INSULATION OUTER DIAMETER: φ0.9mm TO φ1.5mm.
 NOTE 3. PRODUCTION DATE IS SHOWN.
 NOTE 4. FORM IDENTIFICATION MARK IS SHOWN.
 NOTE 5. PRODUCT NAME, DRAWING NUMBER AND QUANTITY ARE SHOWN.
 NOTE 6. MATING AREA: GOLD PLATING OVER NICKEL, TERMINAL AREA: TIN PLATING OVER NICKEL
 OTHER AREA: NICKEL PLATING

注1. 本コネクタは6000個巻きのリールにて供給される。
 注2. 適用電線: AWG#22~#24、被覆外径: φ0.9~1.5mm
 注3. 図示の位置に製造年月を表示する。
 注4. 図示の位置に形状識別記号を表示する。
 注5. 図示の位置に品名、図番、数量を表示する。
 注6. 接触部:ニッケル上金めつき、結線部:ニッケル上錫めつき、その他:ニッケルめつき

3	TAPE	1	PAPER	—	—
2	REEL	1	PAPER	—	—
1	SOCKET CONTACT	6000	COPPER ALLOY	NOTE 6	—
符号 NO.	名称 DESCRIPTION	個数 QTY.	材料 MATERIAL	仕上 FINISH	備考 REMARKS

仕様書 (SPECIFICATION) JACS-11114 (-*)		第1版 (ORIGINAL DATE) 04/DEC/2015		尺度 (SCALE) 1:10		シリーズ (SERIES) HB01		日本航空電子工業株式会社	
一般公差 (GENERAL TOLERANCE)		製図 DR.		名称 (TITLE)		JAE		JAPAN AVIATION ELECTRONICS INDUSTRY, LTD.	
寸法 (DIMENSION)		担当 CHK. K. NAKAZAWA		SOCKET CONTACT #22		図面番号 (DRAWING NO.)		版数 (VER.)	
±0.8	×° ±	査閲 APPD.		質量 (MASS)		SJ116697		1	
±0.4	×°×' ±	承認 APPD. T. KUDOU		—		—		—	
±0.1	×× ±	—		—		—		—	
±	××× ±	—		—		—		—	
単位 (UNIT) : mm		—		—		—		—	

DCF-G-212H(12.08)

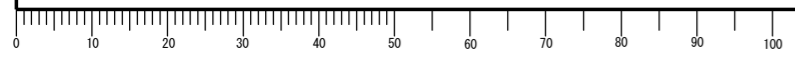

S/W

WISDOM承認 2015/12/08