

Bridgelux® V15 Array

Product Data Sheet DS43



BXRE-27X3001

30X3001

35X3001

40X3001

50X3001

Introduction

V Series



The V Series LED Array products deliver high quality light in a compact and cost-effective solid-state lighting package. These Chip-on-Board (CoB) arrays can be efficiently driven at twice the nominal drive current, enabling design flexibility not previously possible. This high flux density light source is designed to support a wide range of high quality, low cost directional luminaires and replacement lamps for commercial and residential applications.

The V15 LED Array is available in a variety of electrical, CCT and CRI combinations providing substantial design flexibility and energy efficiencies.

Lighting system designs incorporating these LED Arrays deliver comparable performance to 35 Watt ceramic metal halide based luminaires, delivering increased system level efficacy and longer service life. Typical applications include, but are not limited to, replacement lamps, task, accent, spot, track, down light, wide area, security, and wall pack.

Features

- Efficacy of 130 lm/W typical
- Compact high flux density light source
- Uniform high quality illumination
- Minimum 70, 80 and 90 CRI options
- Streamlined thermal path
- Energy Star / ANSI compliant color binning structure with 3SDCM and 4SDCM options
- More energy efficient than incandescent, halogen and fluorescent lamps
- Low voltage DC operation
- Instant light with unlimited dimming

Benefits

- Enhanced optical control
- Clean white light without pixilation
- High quality true color reproduction
- Significantly reduced thermal resistance and increased operating temperatures
- Uniform consistent white light
- Lower operating costs
- Easy to use with daylight and motion detectors to enable increased energy savings
- Reduced maintenance costs
- Environmentally friendly, no disposal issue

Contents

Product Feature Map	2
Product Nomenclature	2
Product Selection Guide	3
Performance at Commonly Used Drive Currents	4
Electrical Characteristics	6
Absolute Maximum Ratings	7
Performance Curves	8
Typical Radiation Pattern	11
Typical Color Spectrum	12
Mechanical Dimensions	13
Color Binning Information	14
Packaging and Labeling	15
Design Resources	17
Precautions	17
Disclaimers	17
About Bridgelux	18

Product Feature Map

Bridgelux arrays are fully engineered devices that provide consistent thermal and optical performance on an engineered mechanical platform. The V Series arrays are

the most compact chip-on-board devices across all of Bridgelux's LED Array products. The arrays incorporate several features to simplify design integration and assembly.

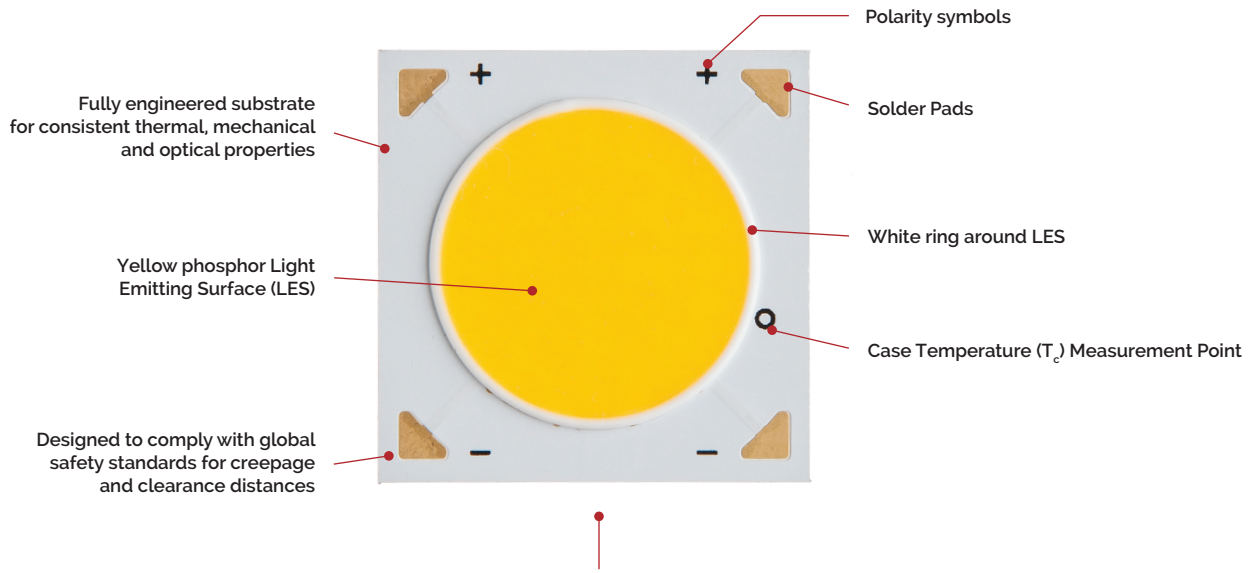

Note: Part number and lot codes are scribed on back of array

Product Nomenclature

The part number designation for Bridgelux V Series LED arrays is explained as follows:

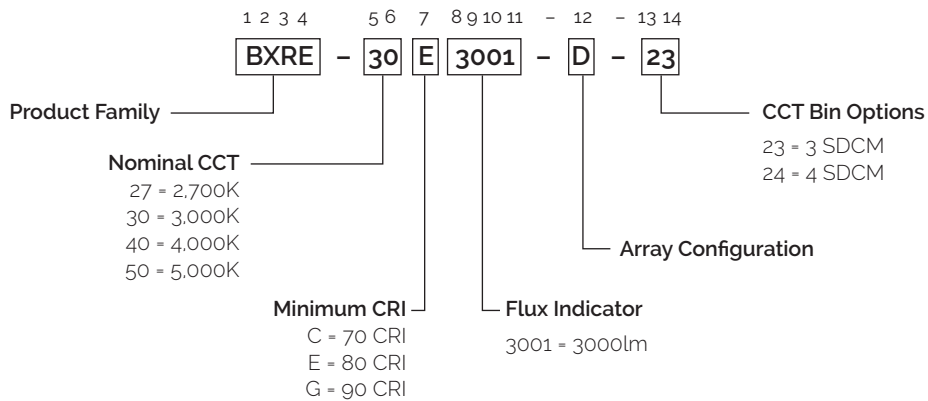

Product Selection Guide

The following product configurations are available:

Table 1: Selection Guide, Pulsed Measurement Data ($T_j = T_c = 25^\circ\text{C}$)

Part Number	Nominal CCT ¹ (K)	CRI ²	Nominal Drive Current ³ (mA)	Typical Pulsed Flux ^{4,5,6} $T_c = 25^\circ\text{C}$ (lm)	Minimum Pulsed Flux ^{6,7} $T_c = 25^\circ\text{C}$ (lm)	Typical V_f (V)	Typical Power (W)	Typical Efficacy (lm/W)
BXRE-27E3001-D-2x	2700	80	700	2994	2725	36.0	25.2	119
BXRE-27G3001-D-2x	2700	90	700	2520	2122	36.0	25.2	100
BXRE-30E3001-D-2x	3000	80	700	3178	2923	36.0	25.2	126
BXRE-30G3001-D-2x	3000	90	700	2596	2457	36.0	25.2	103
BXRE-35E3001-D-2x	3500	80	700	3284	3021	36.0	25.2	130
BXRE-35G3001-D-2x	3500	90	700	2711	2666	36.0	25.2	108
BXRE-40E3001-D-2x	4000	80	700	3372	3222	36.0	25.2	134
BXRE-40G3001-D-2x	4000	90	700	2822	2672	36.0	25.2	112
BXRE-50C3001-D-24	5000	70	700	3654	3350	36.0	25.2	145
BXRE-50E3001-D-24	5000	80	700	3428	3284	36.0	25.2	136
BXRE-50G3001-D-24	5000	90	700	2898	2665	36.0	25.2	115

Table 2: Selection Guide, Stabilized DC Performance ($T_c = 85^\circ\text{C}$)^{8,9}

Part Number	Nominal CCT ¹ (K)	CRI ²	Nominal Drive Current ³ (mA)	Typical DC Flux $T_c = 85^\circ\text{C}$ (lm)	Minimum DC Flux ¹⁰ $T_c = 85^\circ\text{C}$ (lm)	Typical V_f (V)	Typical Power (W)	Typical Efficacy (lm/W)
BXRE-27E3001-D-2x	2700	80	700	2671	2431	35.0	24.5	109
BXRE-27G3001-D-2x	2700	90	700	2248	1893	35.0	24.5	92
BXRE-30E3001-D-2x	3000	80	700	2840	2612	35.0	24.5	116
BXRE-30G3001-D-2x	3000	90	700	2320	2196	35.0	24.5	95
BXRE-35E3001-D-2x	3500	80	700	2935	2700	35.0	24.5	120
BXRE-35G3001-D-2x	3500	90	700	2423	2383	35.0	24.5	99
BXRE-40E3001-D-2x	4000	80	700	3013	2879	35.0	24.5	123
BXRE-40G3001-D-2x	4000	90	700	2522	2388	35.0	24.5	103
BXRE-50C3001-D-24	5000	70	700	3169	2905	35.0	24.5	129
BXRE-50E3001-D-24	5000	80	700	2973	2848	35.0	24.5	121
BXRE-50G3001-D-24	5000	90	700	2513	2311	35.0	24.5	103

Notes for Tables 1 & 2:

- Nominal CCT as defined by ANSI C78.377-2011.
- CRI Values are minimums. Minimum Rg value for 80 CRI products is 0, the minimum Rg values for 90 CRI products is 50.
- Drive current is referred to as nominal drive current.
- Products tested under pulsed condition (10ms pulse width) at nominal test current where T_j (junction temperature) = T_c (case temperature) = 25°C .
- Typical performance values are provided as a reference only and are not a guarantee of performance.
- Bridgelux maintains a $\pm 7\%$ tolerance on flux measurements.
- Minimum flux values at the nominal test current are guaranteed by 100% test.
- Typical stabilized DC performance values are provided as reference only and are not a guarantee of performance.
- Typical performance is estimated based on operation under DC (direct current) with LED array mounted onto a heat sink with thermal interface material and the case temperature maintained at 85°C . Based on Bridgelux test setup, values may vary depending on the thermal design of the luminaire and/or the exposed environment to which the product is subjected.
- Minimum flux values at elevated temperatures are provided for reference only and are not guaranteed by 100% production testing. Based on Bridgelux test setup, values may vary depending on the thermal design of the luminaire and/or the exposed environment to which the product is subjected.

Performance at Commonly Used Drive Currents

V Series LED arrays are tested to the specifications shown using the nominal drive currents in Table 1. V Series may also be driven at other drive currents dependent on specific application design requirements. The performance at any drive current can be derived from the current vs. voltage characteristics shown in Figure 1 and the flux vs. current characteristics shown in Figure 2. The performance at commonly used drive currents is summarized in Table 3.

Table 3: Performance at Commonly Used Drive Currents

Part Number	CRI	Drive Current ¹ (mA)	Typical V_f $T_c = 25^\circ\text{C}$ (V)	Typical Power $T_c = 25^\circ\text{C}$ (W)	Typical Flux ² $T_c = 25^\circ\text{C}$ (lm)	Typical DC Flux ³ $T_c = 85^\circ\text{C}$ (lm)	Typical Efficacy $T_c = 25^\circ\text{C}$ (lm/W)
BXRE-27E3001-D-2x	80	350	34.1	11.9	1605	1432	134
		500	35.0	17.5	2229	1989	127
		700	36.0	25.2	2994	2671	119
		1050	37.6	39.5	4193	3740	106
		1400	39.0	54.6	5176	4617	95
BXRE-27G3001-D-2x	90	350	34.1	11.9	1351	1205	113
		500	35.0	17.5	1876	1674	107
		700	36.0	25.2	2520	2248	100
		1050	37.6	39.5	3529	3148	89
		1400	39.0	54.6	4356	3886	80
BXRE-30E3001-D-2x	80	350	34.1	11.9	1703	1522	143
		500	35.0	17.5	2366	2115	135
		700	36.0	25.2	3178	2840	126
		1050	37.6	39.5	4450	3977	113
		1400	39.0	54.6	5494	4910	101
BXRE-30G3001-D-2x	90	350	34.1	11.9	1392	1244	117
		500	35.0	17.5	1933	1727	110
		700	36.0	25.2	2596	2320	103
		1050	37.6	39.5	3635	3249	92
		1400	39.0	54.6	4488	4011	82
BXRE-35E3001-D-2x	80	350	34.1	11.9	1760	1573	147
		500	35.0	17.5	2445	2185	140
		700	36.0	25.2	3284	2935	130
		1050	37.6	39.5	4599	4110	116
		1400	39.0	54.6	5677	5073	104
BXRE-35G3001-D-2x	90	350	34.1	11.9	1453	1299	122
		500	35.0	17.5	2018	1804	115
		700	36.0	25.2	2711	2423	108
		1050	37.6	39.5	3796	3393	96
		1400	39.0	54.6	4686	4188	86

Notes for Table 3:

1. Alternate drive currents in Table 3 are provided for reference only and are not a guarantee of performance.
2. Bridgelux maintains a $\pm 7\%$ tolerance on flux measurements.
3. Typical stabilized DC performance values are provided as reference only and are not a guarantee of performance.

Performance at Commonly Used Drive Currents

Table 3: Performance at Commonly Used Drive Currents (Continued)

Part Number	CRI	Drive Current ¹ (mA)	Typical V_f $T_c = 25^\circ\text{C}$ (V)	Typical Power $T_c = 25^\circ\text{C}$ (W)	Typical Flux ² $T_c = 25^\circ\text{C}$ (lm)	Typical DC Flux ³ $T_c = 85^\circ\text{C}$ (lm)	Typical Efficacy $T_c = 25^\circ\text{C}$ (lm/W)
BXRE-40E3001-D-2x	80	350	34.1	11.9	1807	1615	151
		500	35.0	17.5	2511	2243	143
		700	36.0	25.2	3372	3013	134
		1050	37.6	39.5	4722	4219	120
		1400	39.0	54.6	5829	5209	107
BXRE-40G3001-D-2x	90	350	34.1	11.9	1513	1352	127
		500	35.0	17.5	2101	1877	120
		700	36.0	25.2	2822	2522	112
		1050	37.6	39.5	3952	3531	100
		1400	39.0	54.6	4878	4359	89
BXRE-50C3001-D-24	70	350	34.1	11.9	1959	1699	164
		500	35.0	17.5	2721	2360	155
		700	36.0	25.2	3654	3169	145
		1050	37.6	39.5	5117	4438	130
		1400	39.0	54.6	6316	5478	116
BXRE-50E3001-D-24	80	350	34.1	11.9	1837	1594	154
		500	35.0	17.5	2552	2214	146
		700	36.0	25.2	3428	2973	136
		1050	37.6	39.5	4800	4163	122
		1400	39.0	54.6	5926	5139	109
BXRE-50G3001-D-24	90	350	34.1	11.9	1553	1347	130
		500	35.0	17.5	2158	1871	123
		700	36.0	25.2	2898	2513	115
		1050	37.6	39.5	4058	3520	103
		1400	39.0	54.6	5010	4345	92

Notes for Table 3:

1. Alternate drive currents in Table 3 are provided for reference only and are not a guarantee of performance.
2. Bridgelux maintains a $\pm 7\%$ tolerance on flux measurements.
3. Typical stabilized DC performance values are provided as reference only and are not a guarantee of performance.

Electrical Characteristics

Table 4: Electrical Characteristics

Part Number	Drive Current (mA)	Forward Voltage Pulsed, $T_c = 25^\circ\text{C}$ (V) ^{1, 2, 3}			Typical Coefficient of Forward Voltage ⁴ $\Delta V_f / \Delta T$ (mV/ $^\circ\text{C}$)	Typical Thermal Resistance Junction to Case ^{5, 6} R_{j-c} (C/W)	Driver Selection Voltages ⁷ (V)	
		Minimum	Typical	Maximum			V_f Min. Hot $T_c = 105^\circ\text{C}$ (V)	V_f Max. Cold $T_c = -40^\circ\text{C}$ (V)
BXRE-xxx3001-D-2x	700	33.3	36.0	38.7	-17	0.16	31.9	39.8
BXRE-xxx3001-D-2x	1400	36.4	39.2	41.7	-17	0.19	35.0	42.8

Notes for Table 4:

1. Parts are tested in pulsed conditions, $T_c = 25^\circ\text{C}$. Pulse width is 10ms.
2. Voltage minimum and maximum are provided for reference only and are not a guarantee of performance.
3. Bridgelux maintains a tester tolerance of $\pm 0.10\text{V}$ on forward voltage measurements.
4. Typical coefficient of forward voltage tolerance is $\pm 0.1\text{mV}$ for nominal current.
5. Thermal resistance values are based from test data of a 3000K 80 CRI product.
6. Thermal resistance value was calculated using total electrical input power; optical power was not subtracted from input power. The thermal interface material used during testing is not included in the thermal resistance value.
7. V_f min hot and max cold values are provided as reference only and are not guaranteed by test. These values are provided to aid in driver design and selection over the operating range of the product.

Absolute Maximum Ratings

Table 5: Maximum Ratings

Parameter	Maximum Rating
LED Junction Temperature (T_j)	150°C
Storage Temperature	-40°C to +105°C
Operating Case Temperature ¹ (T_c)	105°C
Soldering Temperature ²	350°C or lower for a maximum of 10 seconds
Maximum Drive Current ^{3,4,5}	1400mA
Maximum Peak Pulsed Drive Current ⁶	2000mA
Maximum Reverse Voltage ⁷	-60V

Notes for Table 5:

1. For IEC 62717 requirement, please consult your Bridgelux sales representative.
2. Refer to Bridgelux Application Note AN41: Assembly Considerations for Bridgelux V Series LED Arrays.
3. DC Forward Current for LM-80 is the maximum drive current for which LM-80 data is currently available.
4. Lumen maintenance (L70) and lifetime predictions are valid for drive current and case temperature conditions used for LM-80 testing as included in the applicable LM-80 test report for these arrays. Contact your Bridgelux sales representatives for LM-80 report.
5. Arrays may be driven at higher currents however lumen maintenance may be reduced.
6. Bridgelux recommends a maximum duty cycle of 10% and pulse width of 20 ms when operating LED Arrays at maximum peak pulsed current specified. Maximum peak pulsed currents indicate values where LED Arrays can be driven without catastrophic failures.
7. Light emitting diodes are not designed to be driven in reverse voltage and will not produce light under this condition. Maximum rating provided for reference only.

Performance Curves

Figure 1: Drive Current vs. Voltage ($T_j = T_c = 25^\circ\text{C}$)

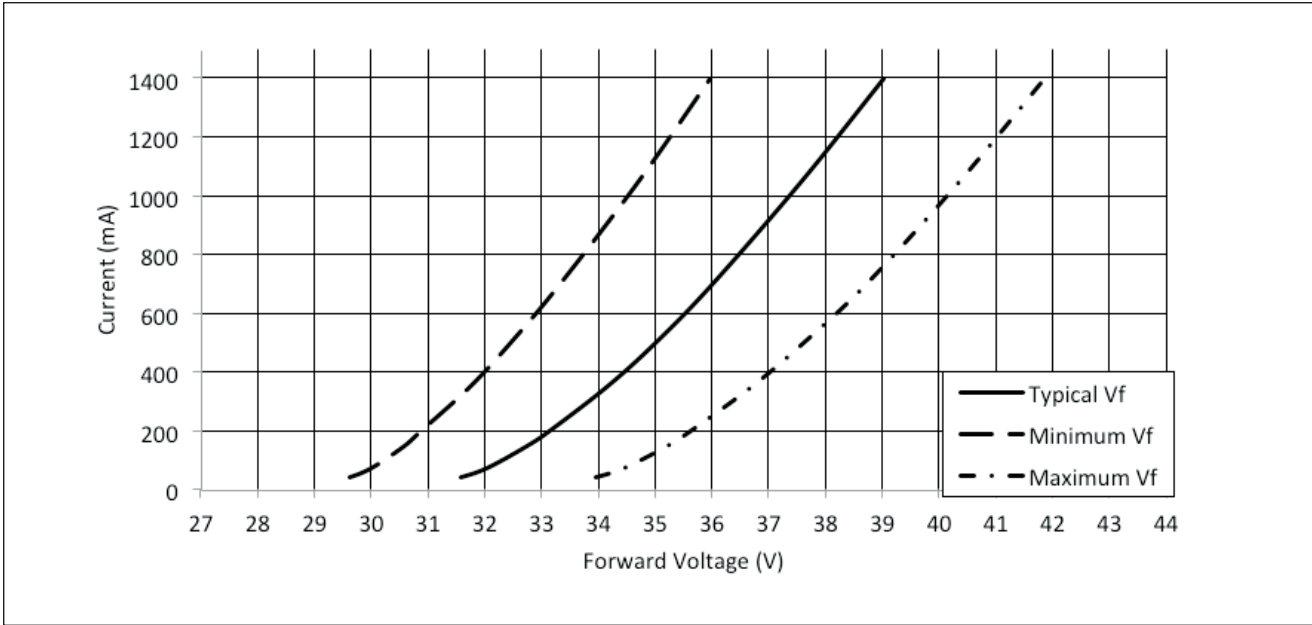
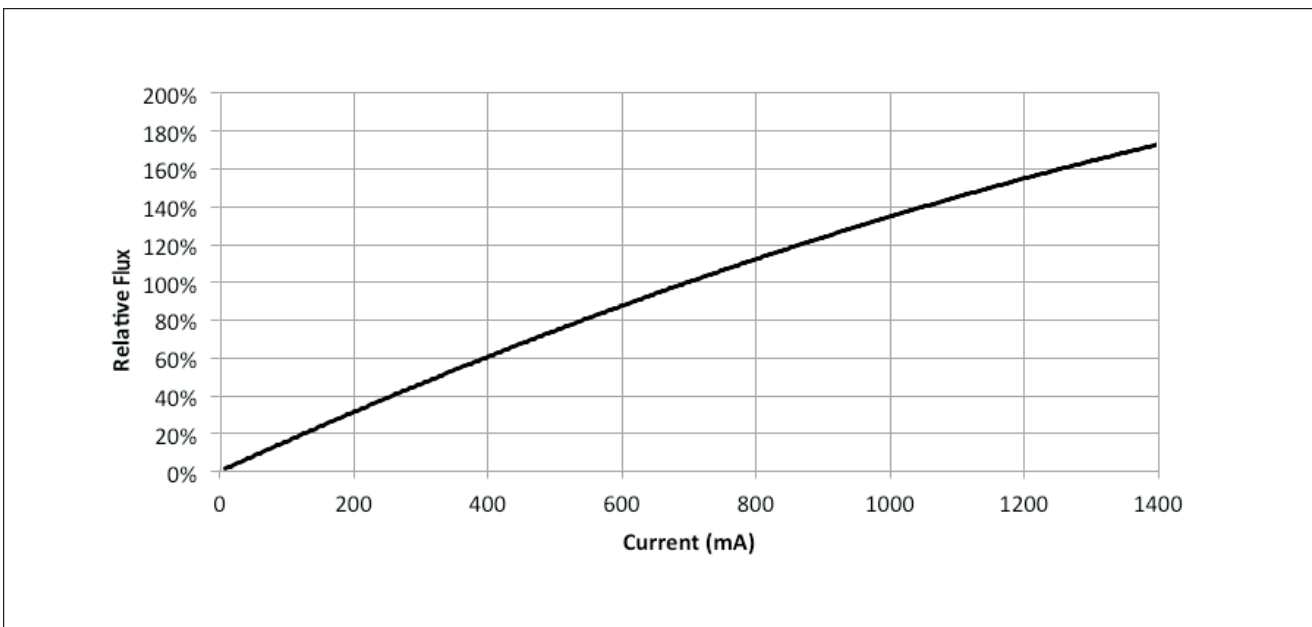

Figure 2: Typical Relative Luminous Flux vs. Drive Current ($T_j = T_c = 25^\circ\text{C}$)



Note for Figure 2:

1. Bridgelux does not recommend driving high power LEDs at low currents. Doing so may produce unpredictable results. Pulse width modulation (PWM) is recommended for dimming effects.

Performance Curves

Figure 3: Typical DC Flux vs. Case Temperature

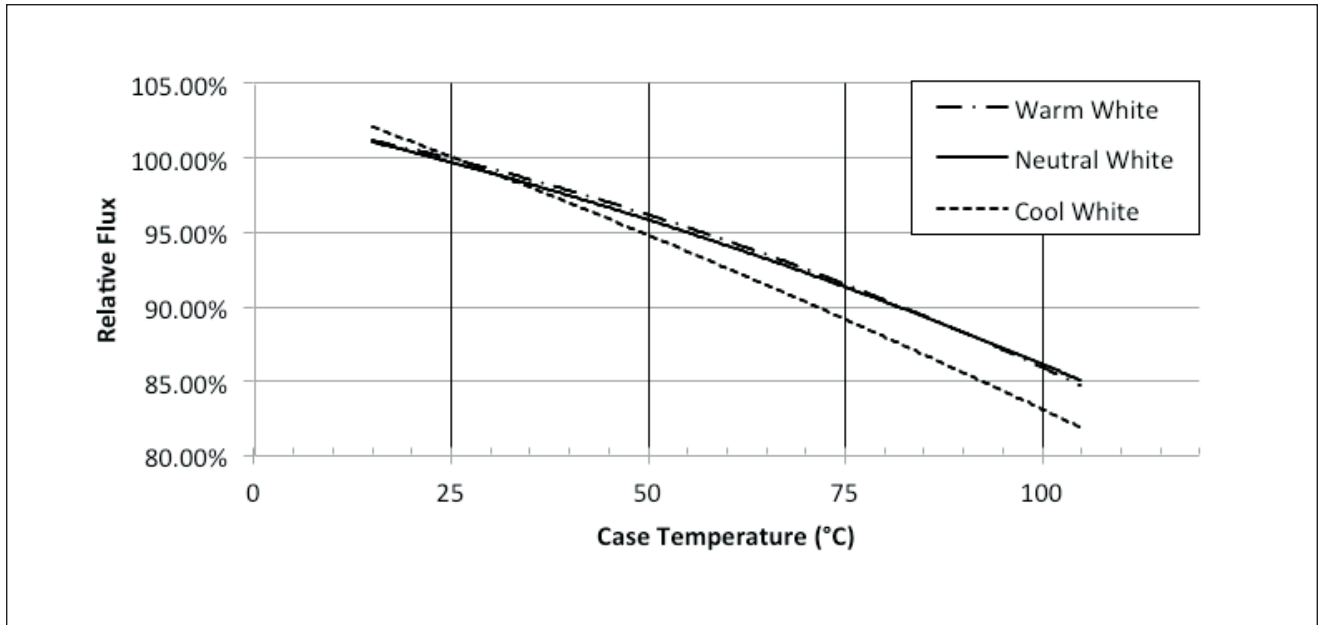
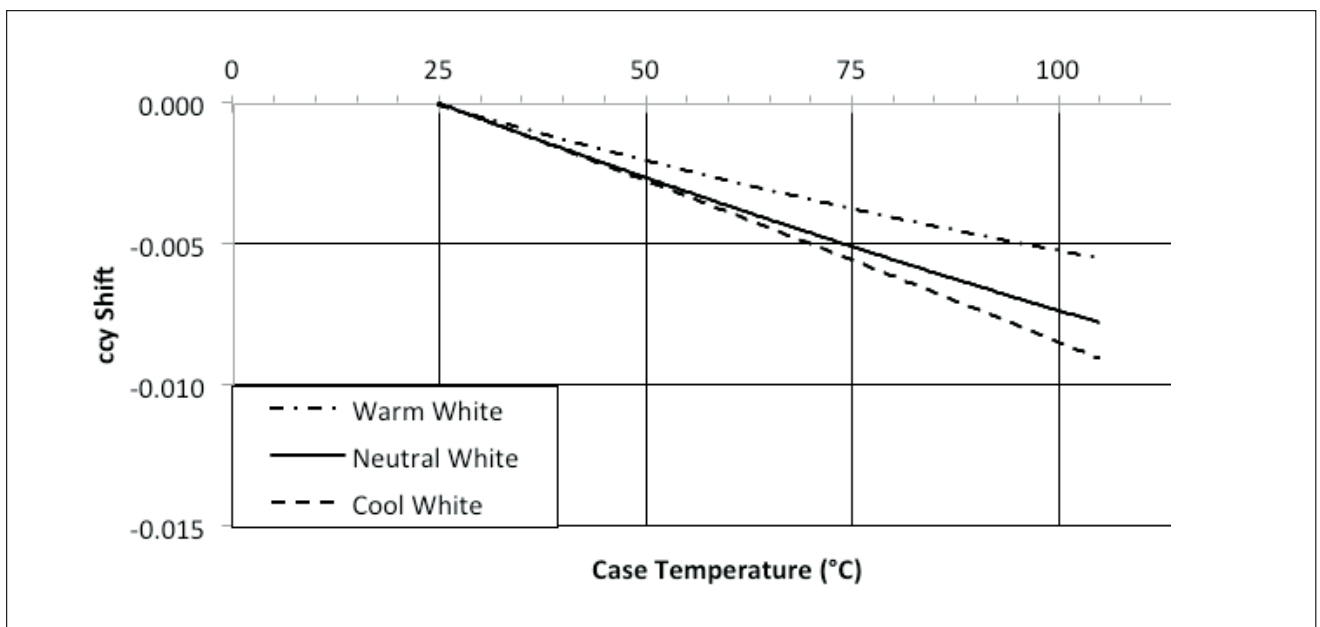

Figure 4: Typical DC ccy Shift vs. Case Temperature



Notes for Figures 3-4:

1. Characteristics shown for warm white based on 3000K and 80 CRI.
2. Characteristics shown for neutral white based on 4000K and 80 CRI.
3. Characteristics shown for cool white based on 5000K and 70 CRI.
4. For other color SKUs, the shift in color will vary. Please contact your Bridgelux Sales Representative for more information.

Performance Curves

Figure 5: Typical DC ccx Shift vs. Case Temperature

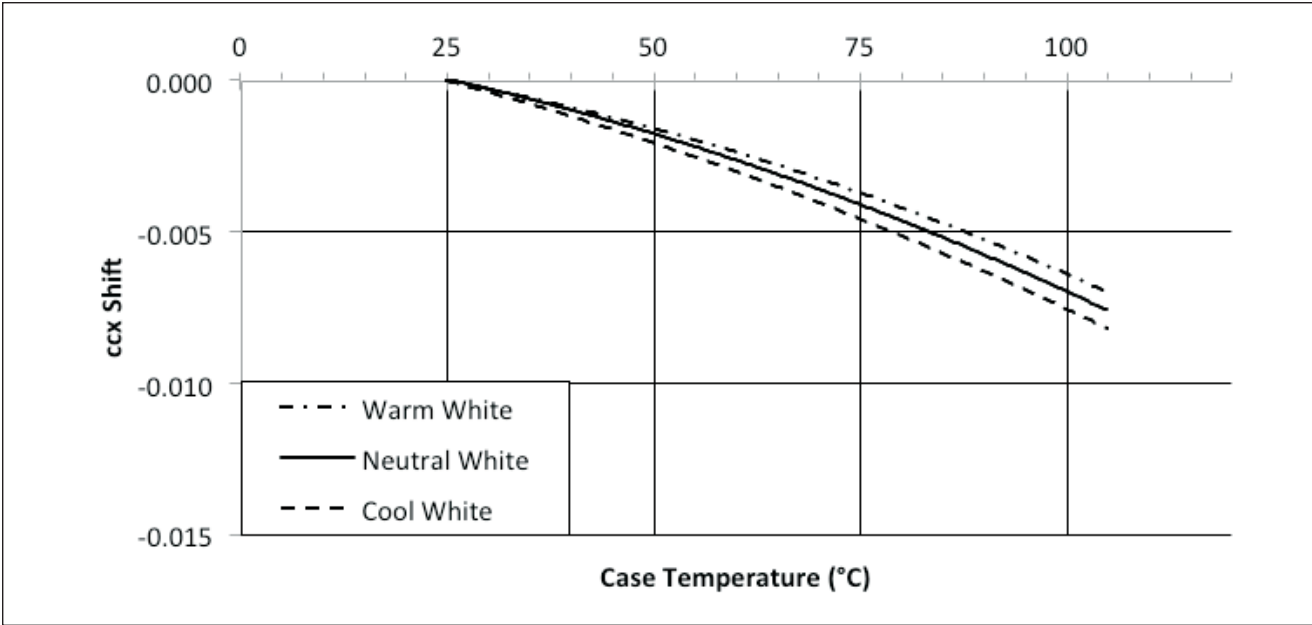

Notes for Figure 5:

- 1. Characteristics shown for warm white based on 3000K and 80 CRI.
- 2. Characteristics shown for neutral white based on 4000K and 80 CRI.
- 3. Characteristics shown for cool white based on 5000K and 70 CRI.
- 4. For other color SKUs, the shift in color will vary. Please contact your Bridgelux Sales Representative for more information.

Typical Radiation Pattern

Figure 6: Typical Spatial Radiation Pattern

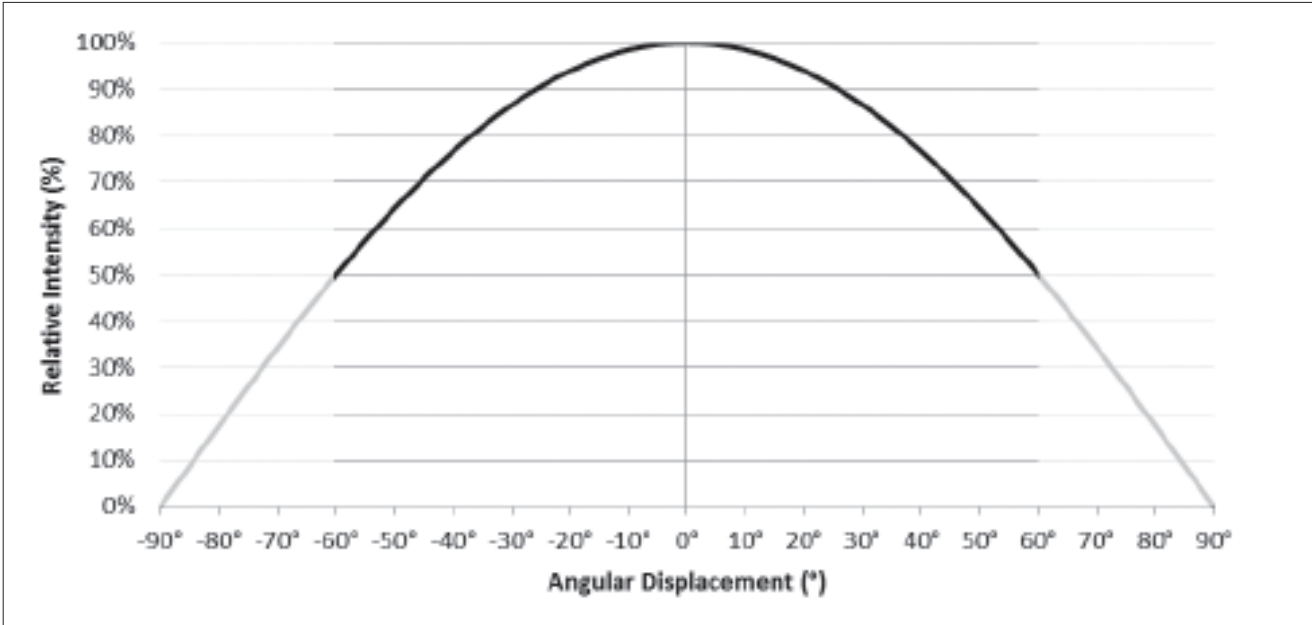

Note for Figure 6:

- 1. Typical viewing angle is 120°.
- 2. The viewing angle is defined as the off axis angle from the centerline where I_v is $\frac{1}{2}$ of the peak value.

Figure 7: Typical Polar Radiation Pattern

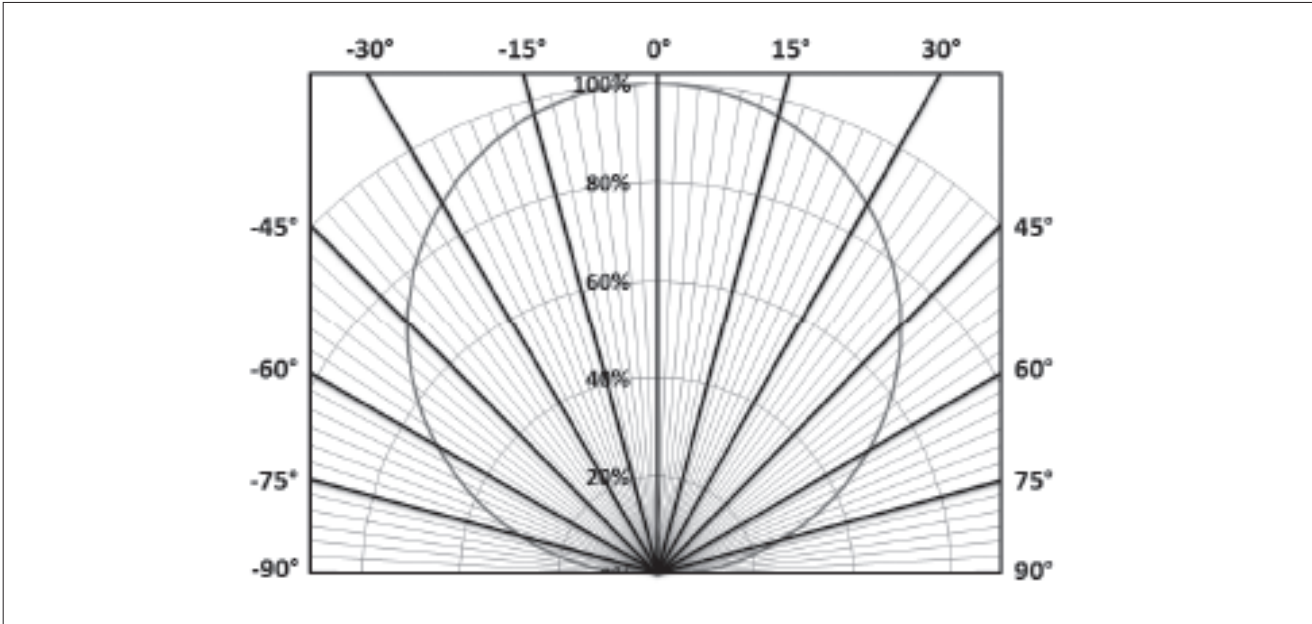

Typical Color Spectrum

Figure 8: Typical Color Spectrum

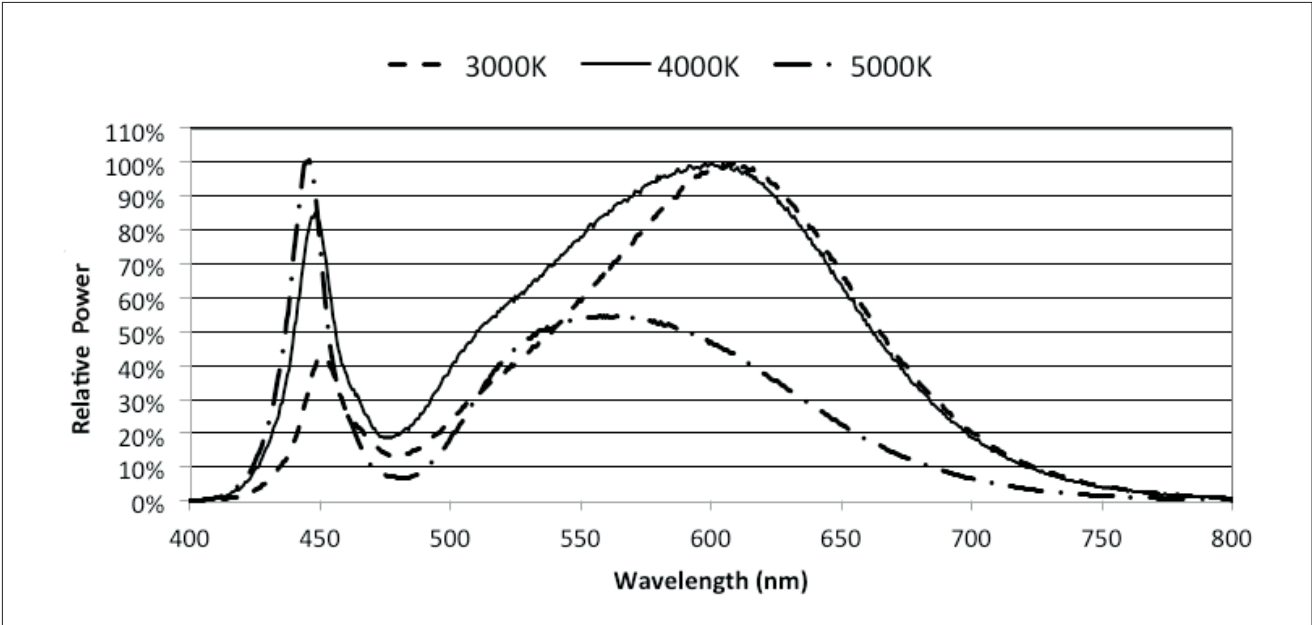

- Notes for Figure 8:
1. Color spectra measured at nominal current for $T_j = T_c = 25^\circ\text{C}$.
 2. Color spectra shown for warm white is 3000K and 80 CRI.
 3. Color spectra shown for neutral white is 4000K and 80 CRI.
 4. Color spectra shown for cool white is 5000K and 70 CRI.

Mechanical Dimensions

Figure 9: Drawing for V15 LED Array

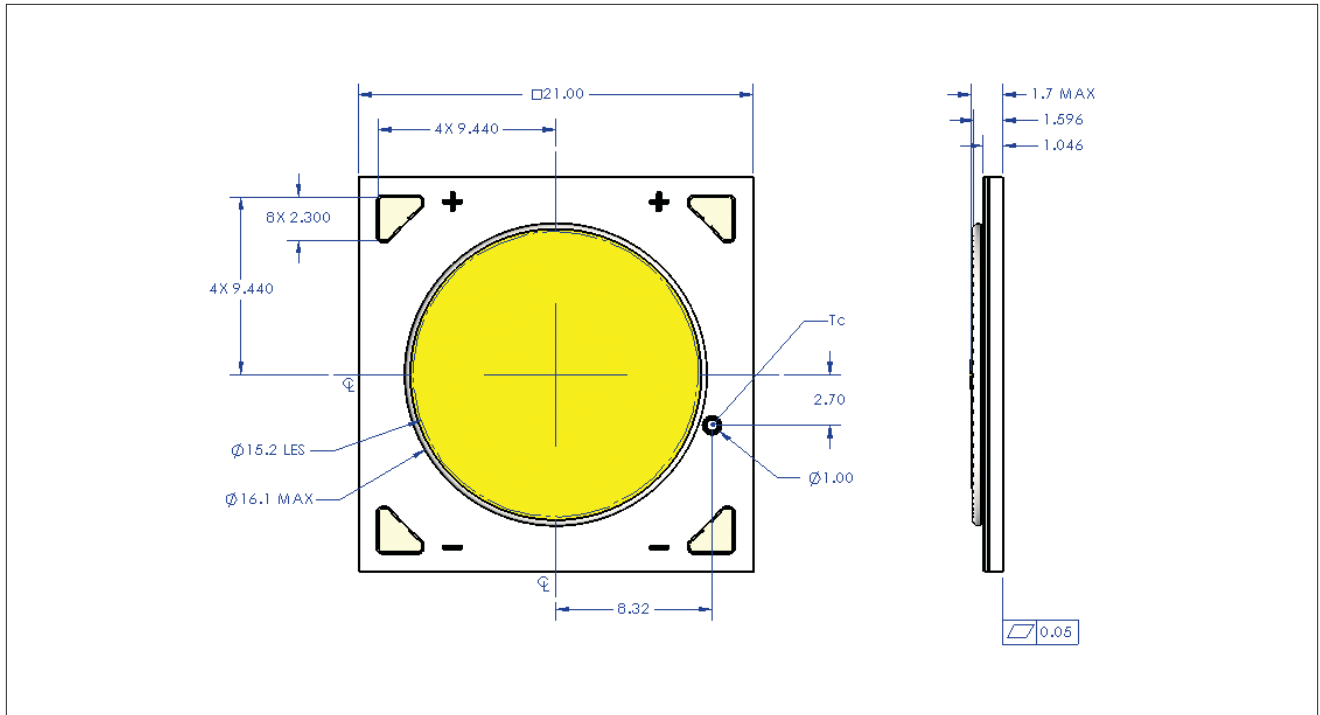

Notes for Figure 9:

1. Solder pads are labeled "+" and "-" to denote positive and negative polarity, respectively.
2. It is not necessary to provide electrical connections to both sets of solder pads. Either set may be used depending on application specific design requirements.
3. Drawings are not to scale.
4. Drawing dimensions are in millimeters.
5. Unless otherwise specified, tolerances are $\pm 0.10\text{mm}$.
6. The optical center of the LED Array is nominally defined by the mechanical center of the array. The light emitting surface (LES) is centered on the mechanical center of the array to a tolerance of $\pm 0.2\text{ mm}$
7. Bridgelux maintains a flatness of 0.1 mm across the mounting surface of the array. Refer to Application Notes AN40 and AN41 for product handling, mounting and heat sink recommendations.

Color Binning Information

Figure 10: Graph of Warm and Neutral White Test Bins in xy Color Space

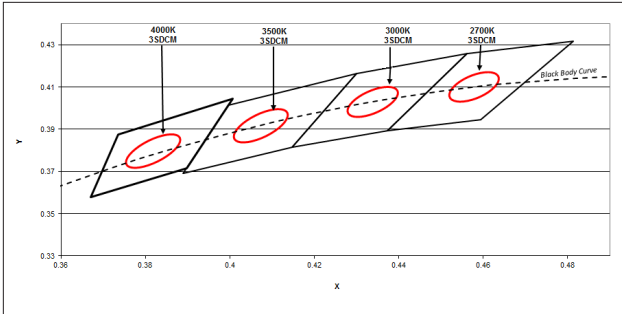

Note: Pulsed Test Conditions, $T_c = 25^\circ\text{C}$

Table 6: Warm and Neutral White xy Bin Coordinates and Associated Typical CCT

Bin Code	2700K	3000K	3500K	4000K
ANSI Bin (for reference only)	(2580K - 2870K)	(2870K - 3220K)	(3220K - 3710K)	(3710K - 4260K)
23 (3SDCM)	(2651K - 2794K)	(2968K - 3136K)	(3369K - 3586K)	(3851K - 4130K)
Center Point (x,y)	(0.4578, 0.4101)	(0.4338, 0.403)	(0.4073, 0.3917)	(0.3818, 0.3797)

Figure 11: Graph of Cool White Test Bins in xy Color Space

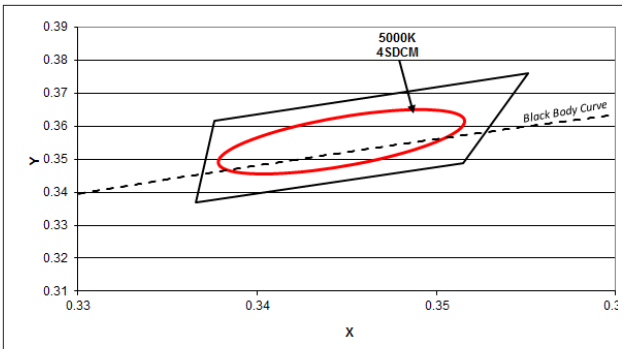

Note: Pulsed Test Conditions, $T_c = 25^\circ\text{C}$

Table 7: Cool White xy Bin Coordinates and Associated Typical CCT

Bin Code	5000K	5600K
ANSI Bin (for reference only)	(4745K - 5311K)	(5310K - 6020K)
24 (4SDCM)	(4801K - 5282K)	(5475K - 5830K)
Center Point (x,y)	(0.3447, 0.3553)	(0.3293, 0.3423)

Packaging and Labeling

Figure 12: Drawing for V Series Packaging Tray

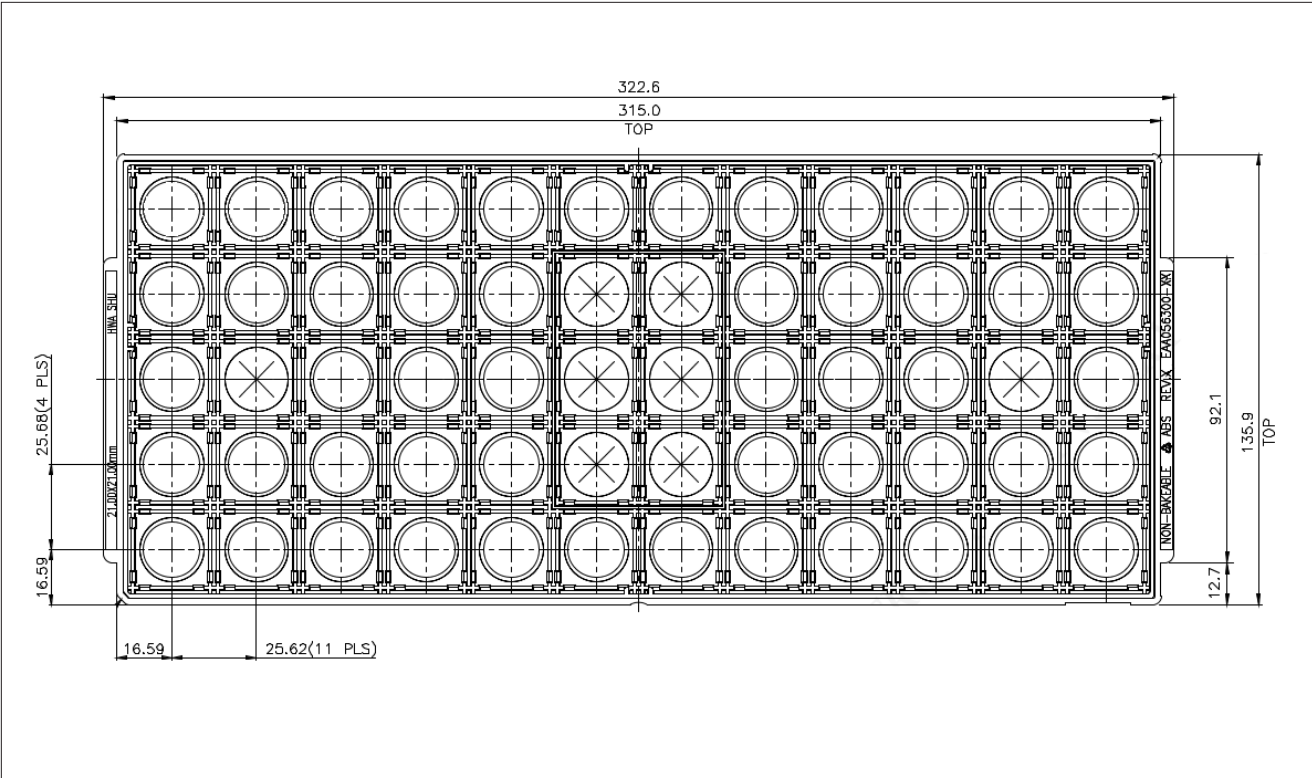

Notes for Figure 12:

1. Dimensions are in millimeters
2. Tolerances: XX ± 0.25, XXX ± 0.13, X'0' = ±0'30'
3. Trays are stackable without interference and will not stick together during unstacking operation

Packaging and Labeling

Figure 13: V Series Packaging and Labeling

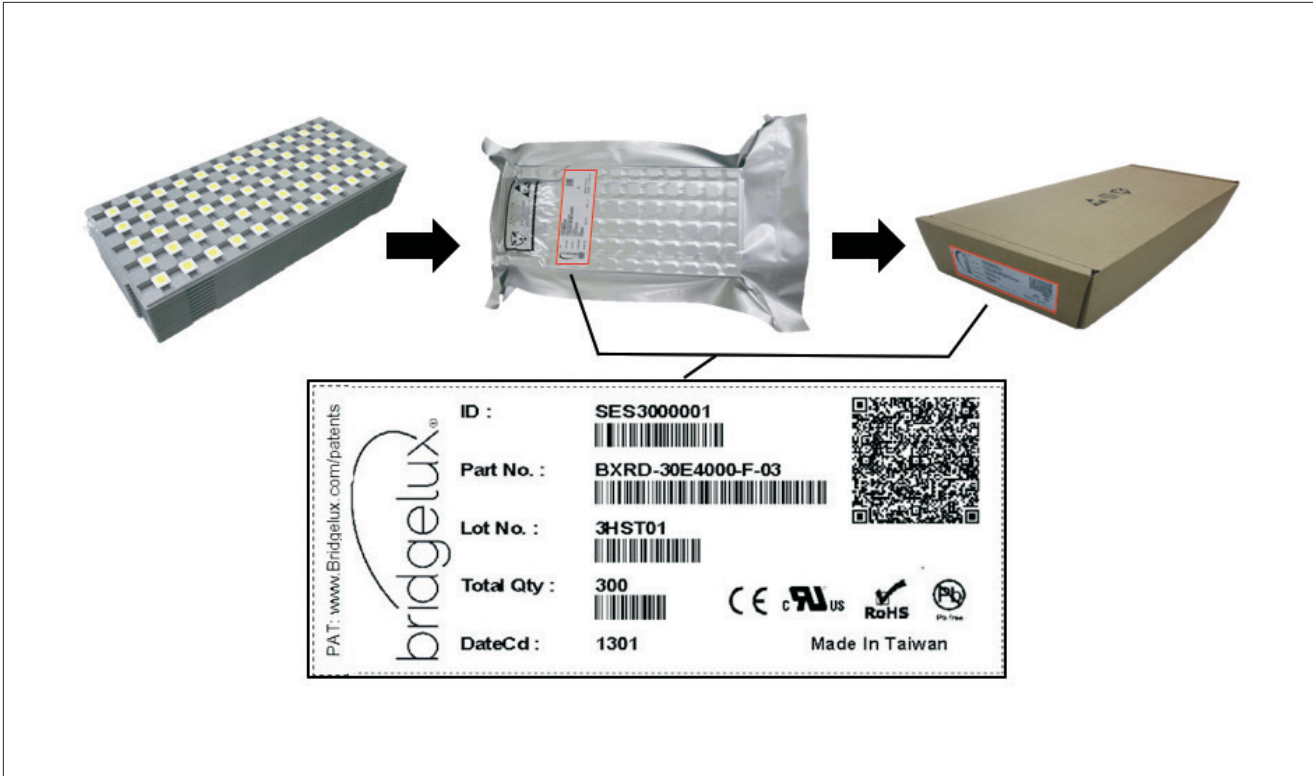

Notes for Figure 13:

1. Each tray holds 60 COB arrays, 10 trays are stacked and one empty tray placed on top to cover the top tray.
2. Stacked trays are to contain only 1 part number and be vacuum sealed in an anti-static bag and placed in its own individual box.
3. Each bag and box is to be labeled as shown above.

Figure 14: Product Labeling

Bridgelux COB arrays have laser markings on the back side of the substrate to help with product identification. In addition to the product identification markings, Bridgelux COB arrays also contain markings for internal Bridgelux manufacturing use only. The image below shows which markings are for customer use and which ones are for Bridgelux internal use only. The Bridgelux internal manufacturing markings are subject to change without notice, however these will not impact the form, function or performance of the COB array.



Design Resources

Application Notes

Bridgelux has developed a comprehensive set of application notes and design resources to assist customers in successfully designing with the V Series product family of LED array products. For a list of resources under development, visit www.bridgelux.com.

Optical Source Models

Optical source models and ray set files are available for all Bridgelux products. For a list of available formats, visit www.bridgelux.com.

3D CAD Models

Three dimensional CAD models depicting the product outline of all Bridgelux Vero LED arrays are available in both IGS and STEP formats. Please contact your Bridgelux sales representative for assistance.

Precautions

CAUTION: CHEMICAL EXPOSURE HAZARD

Exposure to some chemicals commonly used in luminaire manufacturing and assembly can cause damage to the LED array. Please consult Bridgelux Application Note AN41 for additional information.

CAUTION: EYE SAFETY

Eye safety classification for the use of Bridgelux V Series LED arrays is in accordance with IEC specification EN62471: Photobiological Safety of Lamps and Lamp Systems. V Series LED arrays are classified as Risk Group 1 (Low Risk) when operated at or below the maximum drive current. Please use appropriate precautions. It is important that employees working with LEDs are trained to use them safely.

CAUTION: RISK OF BURN

Do not touch the V Series LED array during operation. Allow the array to cool for a sufficient period of time before handling. The V Series LED array may reach elevated temperatures such that could burn skin when touched.

CAUTION

CONTACT WITH LIGHT EMITTING SURFACE (LES)

Avoid any contact with the LES. Do not touch the LES of the LED array or apply stress to the LES (yellow phosphor resin area). Contact may cause damage to the LED array.

Optics and reflectors must not be mounted in contact with the LES (yellow phosphor resin area). Use the mechanical features of the LED array housing, edges and/or mounting holes to locate and secure optical devices as needed.

Disclaimers

MINOR PRODUCT CHANGE POLICY

The rigorous qualification testing on products offered by Bridgelux provides performance assurance. Slight cosmetic changes that do not affect form, fit, or function may occur as Bridgelux continues product optimization.

STANDARD TEST CONDITIONS

Unless otherwise stated, array testing is performed at the nominal drive current.

About Bridgelux: We Build Light That Transforms

At Bridgelux, we help companies, industries and people experience the power and possibility of light. Since 2002, we've designed LED solutions that are high performing, energy efficient, cost effective and easy to integrate. Our focus is on light's impact on human behavior, delivering products that create better environments, experiences and returns—both experiential and financial. And our patented technology drives new platforms for commercial and industrial luminaires.

For more information about the company, please visit
bridgelux.com
twitter.com/Bridgelux
facebook.com/Bridgelux
WeChat ID: BridgeluxInChina



101 Portola Avenue
Livermore, CA 94551
Tel (925) 583-8400
Fax (925) 583-8410
www.bridgelux.com

© 2016 Bridgelux, Inc. All rights reserved 2016. Product specifications are subject to change without notice. Bridgelux, the Bridgelux stylized logo design and V Series are registered trademarks, and Decor Series is a trademark of Bridgelux, Inc. All other trademarks are the property of their respective owners.

Bridgelux V15 Array Series Product Data Sheet DS43 Rev. E (06/2016)