

MODEL IAMA - CONFIGURABLE 3-WAY ISOLATING AMPLIFIER

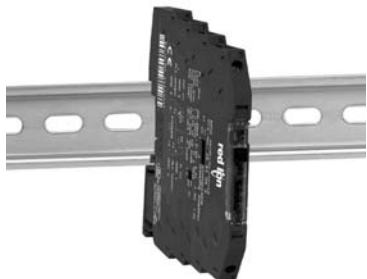

- 3-WAY ISOLATION OF ANALOG SIGNALS
- UNIVERSAL CONVERSION MODULE - INPUTS AND OUTPUTS SELECTED VIA DIP SWITCH SETTINGS
- OVER 35 INPUT AND OUTPUT ANALOG CONVERSION COMBINATIONS
- ULTRA SLIM DESIGN – ONLY 0.244" WIDE
- 19 to 30 VDC POWER



PROCESS CONTROL
 EQUIPMENT FOR HAZARDOUS
 LOCATIONS 31ZN
 CLASS 1, DIV 2
 GROUPS A, B, C, D T5



GENERAL DESCRIPTION

The IAMA can isolate and convert over 35 combinations of analog signal ranges. The IAMA converts and transmits signals linearly proportional to the input. DIP switch range selection eliminates the need to order and stock different modules for each input and output signal range, and allows quick and convenient setup for over 35 standard signal conversions. In addition to the conversion capabilities, the IAMA modules feature optically isolated Input/Output signal circuits and isolated Power to Input, Power to Output circuits. The modules' overall full scale accuracy typically exceed 0.04%. DIN rail mounting saves time and panel space. The units are equipped with universal mounting feet for attachment to standard top hat profile rail according to EN50022 - 35x7.5.

SAFETY SUMMARY

All safety related regulations, local codes and instructions that appear in the manual or on equipment must be observed to ensure personal safety and to prevent damage to either the instrument or equipment connected to it. If equipment is used in a manner not specified by the manufacturer, the protection provided by the equipment may be impaired.

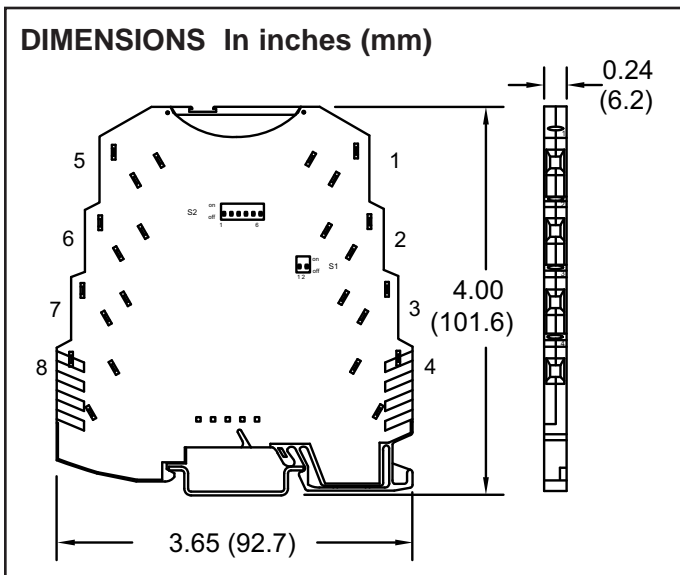
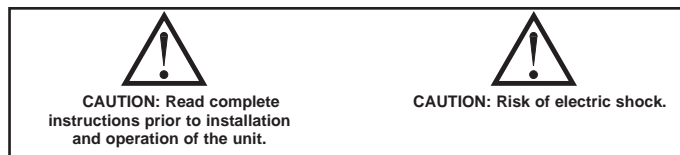

SPECIFICATIONS

- POWER:** 19.2 to 30 V DC, 450 mW max.
- INPUT / OUTPUT RANGES:** See table 1
- SPAN ADJUSTMENT:** Potentiometer, located below transparent top cover.
- MAX INPUT SIGNAL:**
 Current: 50 mA
 Voltage: 30 V
- INPUT RESISTANCE:**
 Current: Approx. 50 Ω
 Voltage: Approx. 100 kΩ
- OUTPUT:** Self-powered (Active)
- MAX OUTPUT SIGNAL:**
 Current: 28 mA/12.5 V
 Voltage: 12.5 V/22 mA
- LOAD RESISTANCE:**
 Current: 500 Ω max.
 Voltage: 10 kΩ min
- OUTPUT COMPLIANCE:**
 Current: 12.5 V max (500 Ω), Ripple: < 20 mV
 Voltage: 22 mA (10 kΩ), Ripple: < 20 mV
- TRANSMISSION ERROR:**
 The transmission error without adjustment is < 0.4%. Using the potentiometer, the error can be adjusted to < 0.1%.
- TEMPERATURE COEFFICIENT:**
 Max.: < 0.01%/K
 Typ.: < 0.002%/K
- CUT-OFF FREQUENCY:** 100 Hz
- STEP RESPONSE (FROM 10 to 90 %):** 3.5 msec
- TEST VOLTAGE (Input/Output/Supply):** 1.5 kV, 50 Hz, 1 min.
- ENVIRONMENTAL CONDITIONS:**
 Operating Temperature Range: -20°C to 65°C (-4°F to 149°F)
 Storage Temperature Range: -40°C to +85°C (-40°F to 185°F)

ORDERING INFORMATION

MODEL NO.	DESCRIPTION	PART NUMBER
IAMA	Configurable 3-Way Isolating Amplifier	IAMA0006

16. TESTS/APPROVALS:



UL LISTED **UL US LISTED**

PROCESS CONTROL EQUIPMENT FOR HAZARDOUS LOCATIONS
31ZN

Class I Div 2 Groups A, B, C, D T5

A) This equipment is suitable for use in Class I, Division 2, Groups A, B, C and D or non-hazardous locations only.

B) Warning - explosion hazard - substitution of components may impair suitability for Class 1, Division 2.

C) Warning - explosion hazard - do not disconnect equipment unless power has been switched off or the area is known to be non-hazardous.

17. CERTIFICATIONS AND COMPLIANCES:

Conformance With EMC Guideline 2004/108/EC And Low Voltage Directive 2006/95/EC

Immunity to Interference According to EN 61000-6-2¹

Discharge of static electricity (ESD)	EN 61000-4-2	Criterion B ²
Electromagnetic HF field	EN 61000-4-3	Criterion A ³
Fast transients (Burst)	EN 61000-4-4	Criterion B ²
Surge voltage capacities (Surge)	EN 61000-4-5	Criterion B ²
Conducted disturbance	EN 61000-4-6	Criterion A ³

Noise Emission According to EN 50081-2

Noise emission of housing	EN 55011 ⁴	Class A ⁵
---------------------------	-----------------------	----------------------

¹ EN 61000 corresponds to IEC 1000

² Criterion B: Temporary impairment to operational behavior that is corrected by the device itself.

³ Criterion A: Normal operating behavior within the defined limits.

⁴ EN 55011 corresponds to CISPR11

⁵ Class A: Area of application industry.

18. **CONNECTIONS:** 12 AWG max., Stripping length: 0.47" (12 mm)

19. **CONSTRUCTION:** Polybutylenterephthalate PBT, black

20. **MOUNTING:** Standard DIN top hat (T) profile rail according to EN50022 - 35x7.5

21. **WEIGHT:** 2 oz. (54 g)

INPUTS

The IAMA accepts a full range of process signal inputs and isolates and converts these signals to common industrial control signals. The input signal combinations are configured by making specific DIP switch selections on the 6 and 2 position DIP switches.

OUTPUTS

As with the input choices, the process signal output of the modules is DIP switch selectable. The maximum output current signal is 28 mA with =500 Ω output resistance and the maximum output voltage signal is 12.5 V with =10 KΩ output resistance. The transmission error without adjustment is < 0.4%. Using the potentiometer, the error can be adjusted to < 0.1%.

TABLE 1 - CONFIGURATION

RANGES		DIP SWITCHES								
		OUTPUT (S2)						INPUT (S1)		
IN	OUT	1	2	3	4	5	6	1	2	
0 - 10 V	0 - 20 mA	off	off	off	off	off	off	off	off	off
	4 - 20 mA	off	off	off	off	off	ON	off	off	
	0 - 10 V	ON	off	ON	off	off	off	off	off	
	2 - 10 V	ON	off	ON	off	off	ON	off	off	
	0 - 5 V	ON	ON	off	off	off	off	off	off	
	1 - 5 V	ON	ON	off	off	off	ON	off	off	
2 - 10 V	0 - 20 mA	off	off	off	ON	ON	off	off	off	
	4 - 20 mA	off	off	off	off	off	off	off	off	
	0 - 10 V	ON	off	ON	ON	ON	off	off	off	
	2 - 10 V	ON	off	ON	off	off	off	off	off	
	0 - 5 V	ON	ON	off	ON	ON	off	off	off	
	1 - 5 V	ON	ON	off	off	off	off	off	off	
0 - 5 V	0 - 20 mA	off	off	off	off	off	off	ON	off	
	4 - 20 mA	off	off	off	off	off	ON	ON	off	
	0 - 10 V	ON	off	ON	off	off	off	ON	off	
	2 - 10 V	ON	off	ON	off	off	ON	ON	off	
	0 - 5 V	ON	ON	off	off	off	off	ON	off	
	1 - 5 V	ON	ON	off	off	off	ON	ON	off	
1 - 5 V	0 - 20 mA	off	off	off	ON	ON	off	ON	off	
	4 - 20 mA	off	off	off	off	off	off	ON	off	
	0 - 10 V	ON	off	ON	ON	ON	off	ON	off	
	2 - 10 V	ON	off	ON	off	off	off	ON	off	
	0 - 5 V	ON	ON	off	ON	ON	off	off	ON	
	1 - 5 V	ON	ON	off	off	off	off	ON	off	
0 - 20 mA	0 - 20 mA	off	off	off	off	off	off	off	ON	
	4 - 20 mA	off	off	off	off	off	ON	off	ON	
	0 - 10 V	ON	off	ON	off	off	off	off	ON	
	2 - 10 V	ON	off	ON	off	off	ON	off	ON	
	0 - 5 V	ON	ON	off	off	off	off	off	ON	
	1 - 5 V	ON	ON	off	off	off	ON	off	ON	
4 - 20 mA	0 - 20 mA	off	off	off	ON	ON	off	off	ON	
	4 - 20 mA	off	off	off	off	off	off	off	ON	
	0 - 10 V	ON	off	ON	ON	ON	off	off	ON	
	2 - 10 V	ON	off	ON	off	off	off	off	ON	
	0 - 5 V	ON	ON	off	ON	ON	off	off	ON	
	1 - 5 V	ON	ON	off	off	off	off	off	ON	

BLOCK DIAGRAM

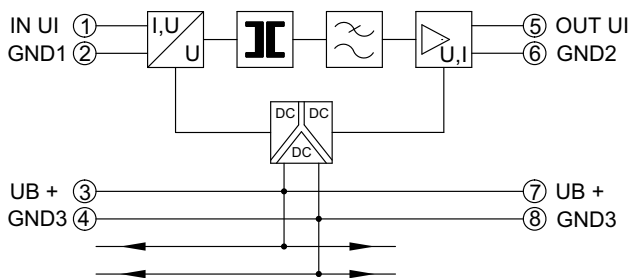

WIRING CONNECTIONS

Primary power is connected to terminals 7 or 3 (19.2 – 30 VDC) and 8 or 4 (GND 3). For best results, the power should be relatively “clean” and within the specified variation limits. Drawing power from heavily loaded circuits or from circuits that also power loads that cycle on and off, should be avoided.

The input signal is connected to pins 1 (In U,I) and 2 (GND 1). Connections for the output signal are made on pins 5 (Out U,I) and 6 (GND 2).

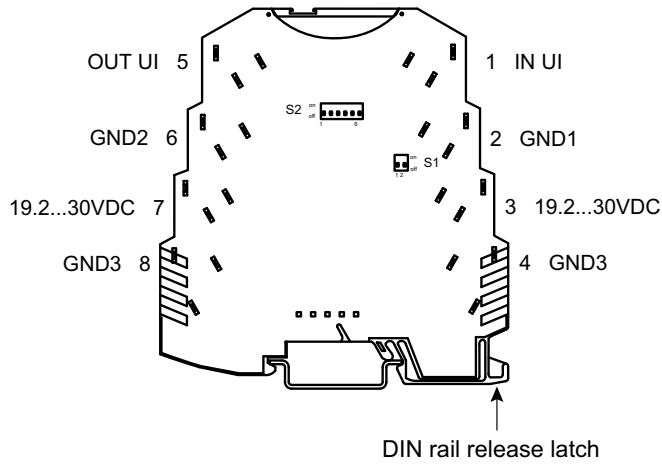

INSTALLATION

The unit is equipped with a universal mounting foot for attachment to standard DIN style top hat (T) profile rail according to EN50022 - 35 x 7.5 and 35 x 15. The unit should be installed in a location that does not exceed the maximum operating temperature and provides good air circulation. Placing the unit near devices that generate excessive heat should be avoided.

T Rail Installation

To install the IAMA on a “T” style rail, angle the module so that the top groove of the “foot” is located over the lip of the top rail. Push the module toward the rail until it snaps into place. To remove a module from the rail, insert a screwdriver into the slot on the bottom of the “foot”, and pry upwards on the module until it releases from the rail.

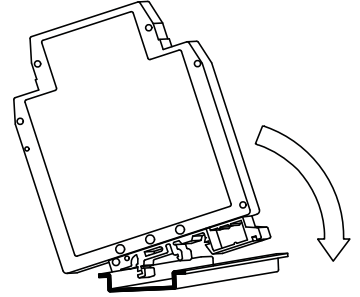

APPLICATION

Cost efficiency measurements of a printing company included the reduction of bulk stock of the various inks used in their printing processes. The company currently had various ink flow and level devices with different current and voltage outputs and wanted to record these measurements into a control room PC. Several IAMA Universal Signal Conditioning Modules were the answer. The IAMA’s universal input allowed for easy signal conditioning of the various output signals to the required PC’s Bus Board 0 to 10 VDC input signal. In this case, the IAMA’s re-transmitted 0 to 10 VDC output was field calibrated, negating the expense and time required to rewrite the PC’s software parameters. In addition to accepting multiple signal types, the IAMA also provides the necessary electrical isolation between the control room PC and the hazards of the printing floor electrical noise.

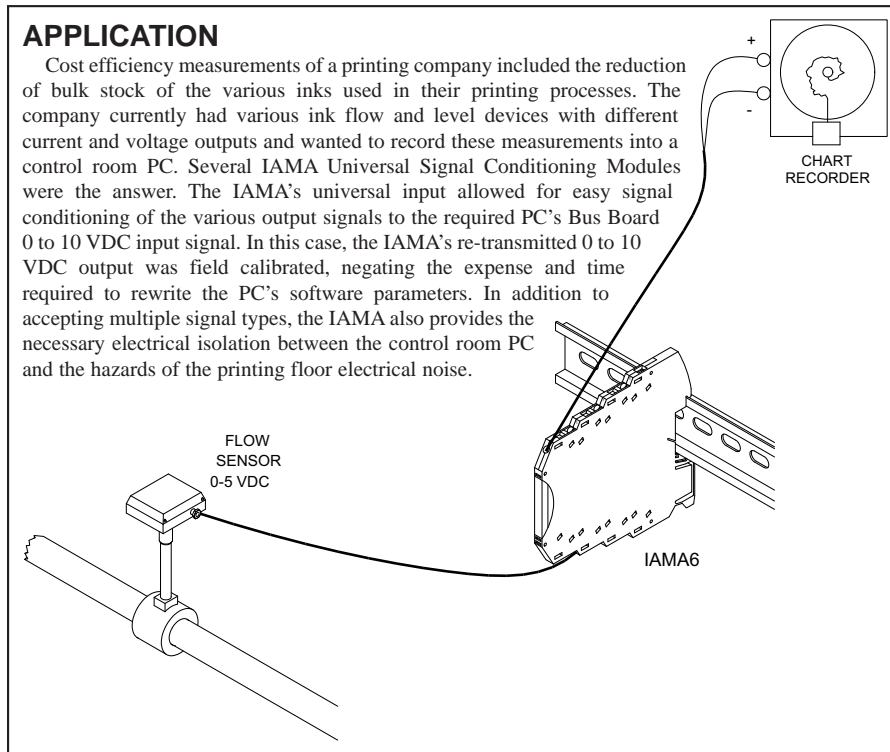

LIMITED WARRANTY

The Company warrants the products it manufactures against defects in materials and workmanship for a period limited to two years from the date of shipment, provided the products have been stored, handled, installed, and used under proper conditions. The Company's liability under this limited warranty shall extend only to the repair or replacement of a defective product, at The Company's option. The Company disclaims all liability for any affirmation, promise or representation with respect to the products.

The customer agrees to hold Red Lion Controls harmless from, defend, and indemnify RLC against damages, claims, and expenses arising out of subsequent sales of RLC products or products containing components manufactured by RLC and based upon personal injuries, deaths, property damage, lost profits, and other matters which Buyer, its employees, or sub-contractors are or may be to any extent liable, including without limitation penalties imposed by the Consumer Product Safety Act (P.L. 92-573) and liability imposed upon any person pursuant to the Magnuson-Moss Warranty Act (P.L. 93-637), as now in effect or as amended hereafter.

No warranties expressed or implied are created with respect to The Company's products except those expressly contained herein. The Customer acknowledges the disclaimers and limitations contained herein and relies on no other warranties or affirmations.

Red Lion Controls
Headquarters
20 Willow Springs Circle
York PA 17406
Tel +1 (717) 767-6511
Fax +1 (717) 764-0839

Red Lion Controls
Europe
Softwareweg 9
NL - 3821 BN Amersfoort
Tel +31 (0) 334 723 225
Fax +31 (0) 334 893 793

Red Lion Controls
India
201-B, 2nd Floor, Park Centra
Opp 32 Mile Stone, Sector-30
Gurgaon-122002 Haryana, India
Tel +91 984 487 0503

Red Lion Controls
China
Unit 302, XinAn Plaza
Building 13, No.99 Tianzhou Road
ShangHai, P.R. China 200223
Tel +86 21 6113 3688
Fax +86 21 6113 3683