



STFV3N150 , STFW3N150 STP3N150, STW3N150

N-channel 1500 V, 6 Ω 2.5 A, PowerMESH™ Power MOSFET
TO-220, TO-220FH, TO-247, TO-3PF

Features

Type	V _{DSS}	R _{DS(on)} max	I _D	P _w
STFV3N150	1500 V	< 9 Ω	2.5 A	30 W
STFW3N150 ⁽¹⁾	1500 V	< 9 Ω	2.5 A	83 W
STP3N150	1500 V	< 9 Ω	2.5 A	140 W
STW3N150	1500 V	< 9 Ω	2.5 A	140 W

1. All data which refers solely to the TO-3PF package is preliminary

- 100% avalanche tested
- Intrinsic capacitances and Q_g minimized
- High speed switching
- Fully isolated TO-3PF and TO-220FH plastic packages
- Creepage distance path is 5.4 mm (typ.) for TO-3PF
- Creepage distance path is > 4 mm for TO-220FH

Application

- Switching applications

Description

Using the well consolidated high voltage MESH OVERLAY™ process, STMicroelectronics has designed an advanced family of very high voltage Power MOSFETs with outstanding performances. The strengthened layout coupled with the company's proprietary edge termination structure, gives the lowest R_{DS(on)} per area, unrivalled gate charge and switching characteristics.

Table 1. Device summary

Order codes	Marking	Package	Packaging
STFV3N150	3N150	TO-220FH	Tube
STFW3N150	3N150	TO-3PF	Tube
STP3N150	3N150	TO-220	Tube
STW3N150	3N150	TO-247	Tube

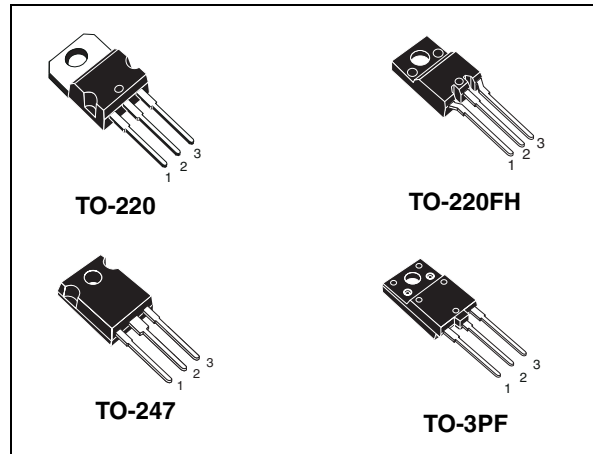
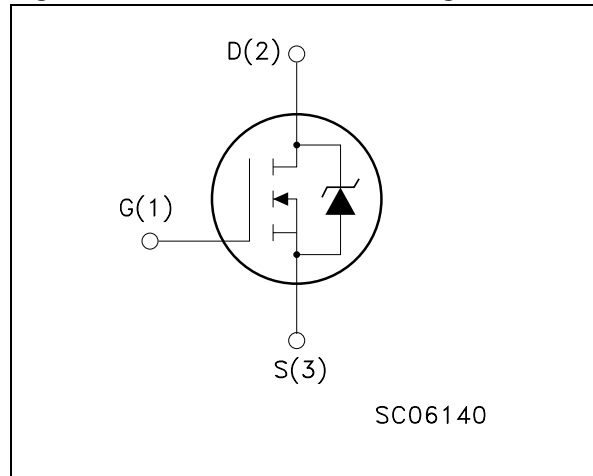

Figure 1. Internal schematic diagram



Contents

1	Electrical ratings	3
2	Electrical characteristics	4
	2.1 Electrical characteristics (curves)	6
3	Test circuits	9
4	Package mechanical data	10
5	Revision history	14

1 Electrical ratings

Table 2. Absolute maximum ratings

Symbol	Parameter	Value			Unit
		TO-220,TO-247	TO-220FH	TO-3PF	
V_{DS}	Drain-source voltage ($V_{GS} = 0$)	1500			V
V_{GS}	Gate-source voltage	± 30			V
I_D	Drain current (continuous) at $T_C = 25\text{ }^\circ\text{C}$	2.5	2.5 ⁽¹⁾	2.5 ⁽¹⁾	A
I_D	Drain current (continuous) at $T_C = 100\text{ }^\circ\text{C}$	1.6	1.6 ⁽¹⁾	1.6 ⁽¹⁾	A
$I_{DM}^{(2)}$	Drain current (pulsed)	10	10 ⁽¹⁾	10 ⁽¹⁾	A
P_{TOT}	Total dissipation at $T_C = 25\text{ }^\circ\text{C}$	140	30	83	W
V_{ISO}	Insulation withstand voltage (RMS) from all three leads to external heat sink ($t=1\text{ s}; T_C=25\text{ }^\circ\text{C}$)		2500	TBD	V
	Derating factor	1.12	0.24	0.67	W/ $^\circ\text{C}$
T_{stg}	Storage temperature	-50 to 150			$^\circ\text{C}$
T_j	Max. operating junction temperature	150			$^\circ\text{C}$

1. Limited by maximum temperature allowed
2. Pulse width limited by safe operating area

Table 3. Thermal data

Symbol	Parameter	TO-220	TO-247	TO-220FH	TO-3PF	Unit
$R_{thj-case}$	Thermal resistance junction-case max	0.89		4.17	1.5	$^\circ\text{C}/\text{W}$
$R_{thj-amb}$	Thermal resistance junction-ambient max	62.5	50	62.5	50	$^\circ\text{C}/\text{W}$
T_j	Maximum lead temperature for soldering purpose	300				$^\circ\text{C}/\text{W}$

Table 4. Avalanche characteristics

Symbol	Parameter	Max value	Unit
I_{AR}	Avalanche current, repetitive or not-repetitive (pulse width limited by T_j max)	2.5	A
E_{AS}	Single pulse avalanche energy (starting $T_j = 25\text{ }^\circ\text{C}$, $I_D = I_{AR}$, $V_{DD} = 50\text{ V}$)	450	mJ

2 Electrical characteristics

($T_{\text{case}} = 25\text{ °C}$ unless otherwise specified)

Table 5. On /off states

Symbol	Parameter	Test conditions	Min.	Typ.	Max.	Unit
$V_{(BR)DSS}$	Drain-source breakdown voltage	$I_D = 1\text{ mA}$, $V_{GS} = 0$	1500			V
I_{DSS}	Zero gate voltage drain current ($V_{GS} = 0$)	$V_{DS} = \text{Max rating}$ $V_{DS} = \text{Max rating}$, $T_C = 125\text{ °C}$			10 500	μA μA
I_{GSS}	Gate-body leakage current ($V_{DS} = 0$)	$V_{GS} = \pm 30\text{ V}$			± 100	nA
$V_{GS(th)}$	Gate threshold voltage	$V_{DS} = V_{GS}$, $I_D = 250\text{ }\mu\text{A}$	3	4	5	V
$R_{DS(on)}$	Static drain-source on resistance	$V_{GS} = 10\text{ V}$, $I_D = 1.3\text{ A}$		6	9	Ω

Table 6. Dynamic

Symbol	Parameter	Test conditions	Min.	Typ.	Max.	Unit
$g_{fs}^{(1)}$	Forward transconductance	$V_{DS} = 30\text{ V}$, $I_D = 1.3\text{ A}$		2.6		S
C_{iss} C_{oss} C_{rss}	Input capacitance Output capacitance Reverse transfer capacitance	$V_{DS} = 25\text{ V}$, $f = 1\text{ MHz}$, $V_{GS} = 0$		939 102 13.2		pF pF pF
$C_{oss\text{ eq.}}^{(2)}$	Equivalent output capacitance	$V_{DS} = 0$ to 1200 V , $V_{GS} = 0$		100		pF
R_g	Gate input resistance	$f = 1\text{ MHz}$ Gate DC Bias = 0 Test signal level = 20 mV open drain		4		Ω
Q_g Q_{gs} Q_{gd}	Total gate charge Gate-source charge Gate-drain charge	$V_{DD} = 1200\text{ V}$, $I_D = 2.5\text{ A}$, $V_{GS} = 10\text{ V}$ (see Figure 19)		29.3 4.6 17		nC nC nC

1. Pulsed: Pulse duration = 300 μs , duty cycle 1.5%
2. $C_{oss\text{ eq.}}$ is defined as a constant equivalent capacitance giving the same charging time as C_{oss} when V_{DS} increases from 0 to 80% V_{DSS}

Table 7. Switching times

Symbol	Parameter	Test conditions	Min.	Typ.	Max	Unit
$t_{d(on)}$	Turn-on delay time	$V_{DD} = 750 \text{ V}$, $I_D = 1.25 \text{ A}$, $R_G = 4.7 \Omega$, $V_{GS} = 10 \text{ V}$ (see Figure 18)		24		ns
t_r	Rise time			47		ns
$t_{d(off)}$	Turn-off-delay time			45		ns
t_f	Fall time			61		ns

Table 8. Source drain diode

Symbol	Parameter	Test conditions	Min.	Typ.	Max	Unit
I_{SD}	Source-drain current				2.5	A
$I_{SDM}^{(1)}$	Source-drain current (pulsed)				10	A
$V_{SD}^{(2)}$	Forward on voltage	$I_{SD} = 2.5 \text{ A}$, $V_{GS} = 0$			1.6	V
t_{rr}	Reverse recovery time	$I_{SD} = 2.5 \text{ A}$, $di/dt = 100 \text{ A}/\mu\text{s}$ $V_{DD} = 60 \text{ V}$ (see Figure 20)		410		ns
Q_{rr}	Reverse recovery charge			2.4		μC
I_{RRM}	Reverse recovery current			11.7		A
t_{rr}	Reverse recovery time	$I_{SD} = 2.5 \text{ A}$, $di/dt = 100 \text{ A}/\mu\text{s}$ $V_{DD} = 60 \text{ V}$, $T_j = 150 \text{ }^\circ\text{C}$ (see Figure 20)		540		ns
Q_{rr}	Reverse recovery charge			3.3		μC
I_{RRM}	Reverse recovery current			12.3		A

1. Pulse width limited by safe operating area

2. Pulsed: pulse duration = 300 μs , duty cycle 1.5%

2.1 Electrical characteristics (curves)

Figure 2. Safe operating area for TO-220

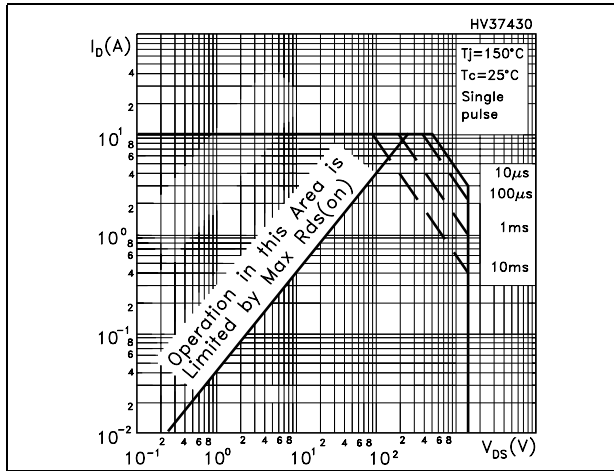

Figure 3. Thermal impedance for TO-220

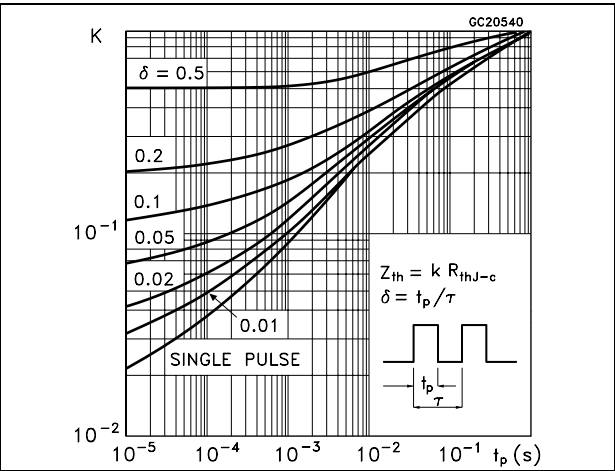

Figure 4. Safe operating area for TO-220FH

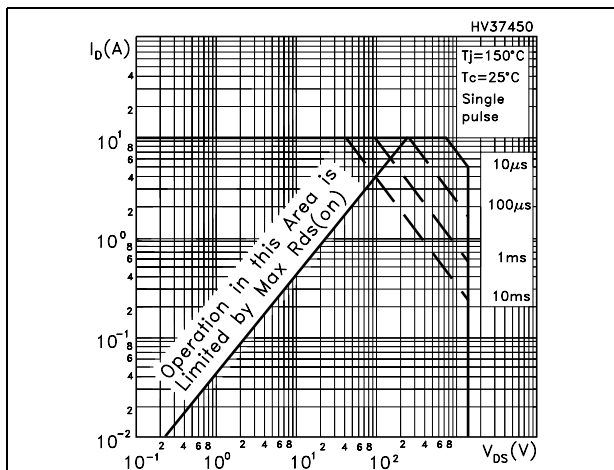

Figure 5. Thermal impedance for TO-220FH

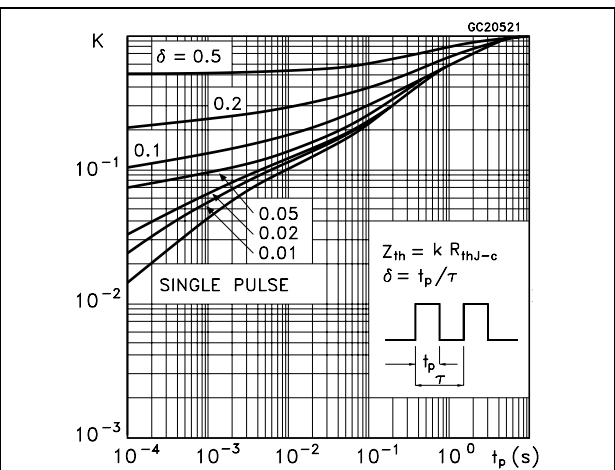

Figure 6. Safe operating area for TO-247

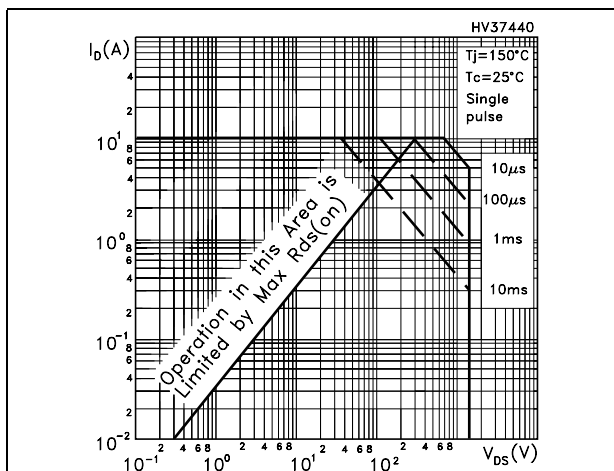

Figure 7. Thermal impedance for TO-247

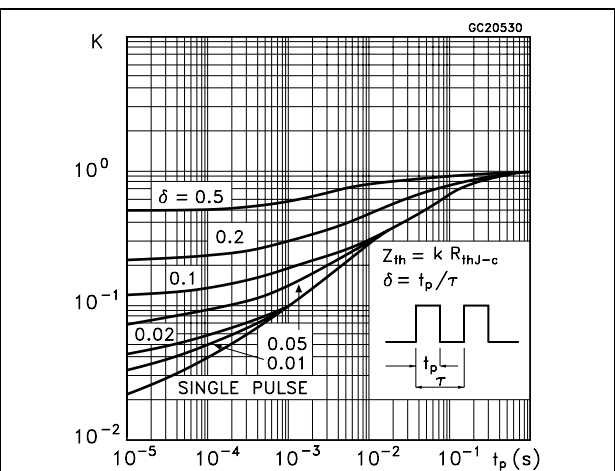

Figure 8. Output characteristics

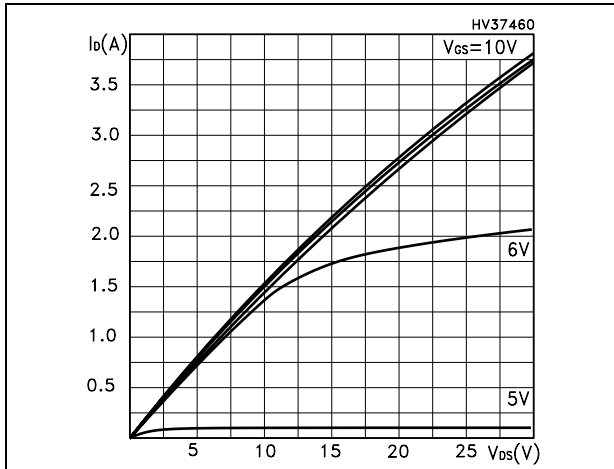

Figure 9. Transfer characteristics

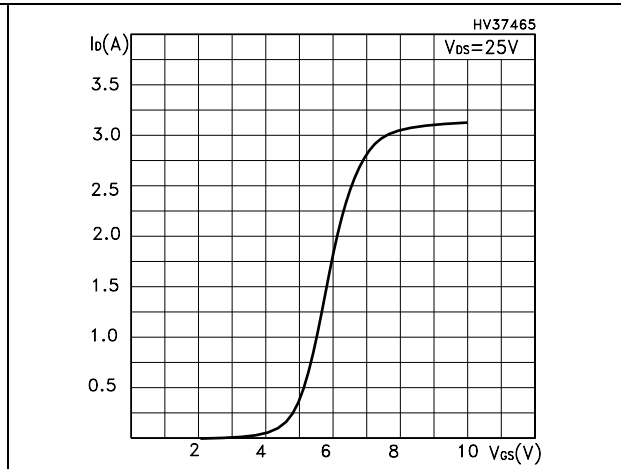

Figure 10. Normalized BV_{DSS} vs. temperature

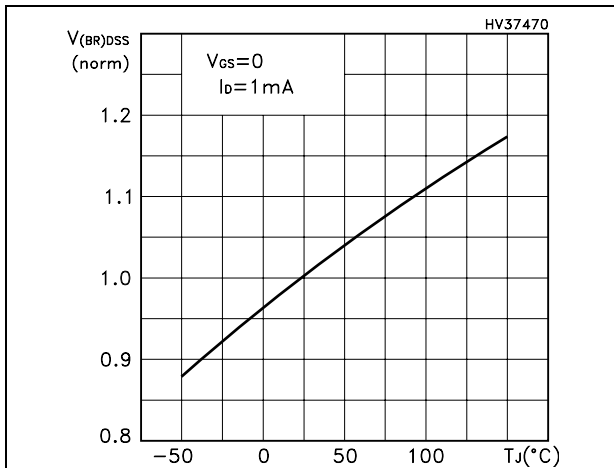

Figure 11. Static drain-source on resistance

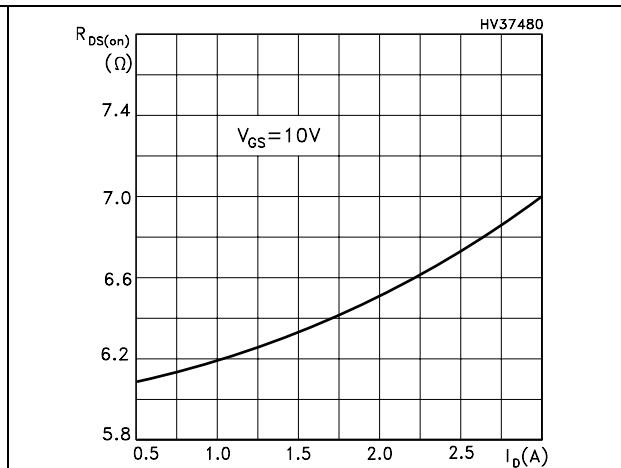

Figure 12. Gate charge vs. gate-source voltage

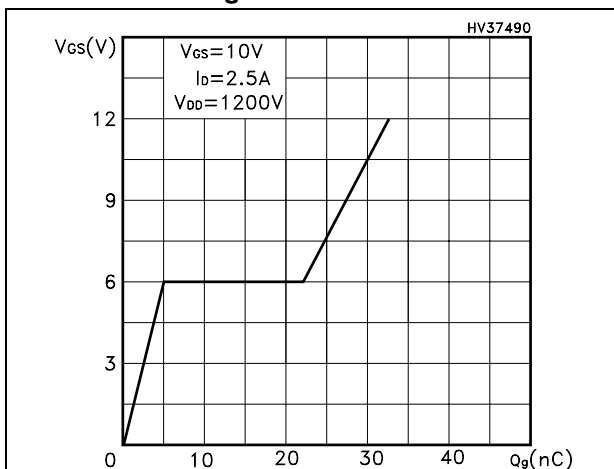

Figure 13. Capacitance variations

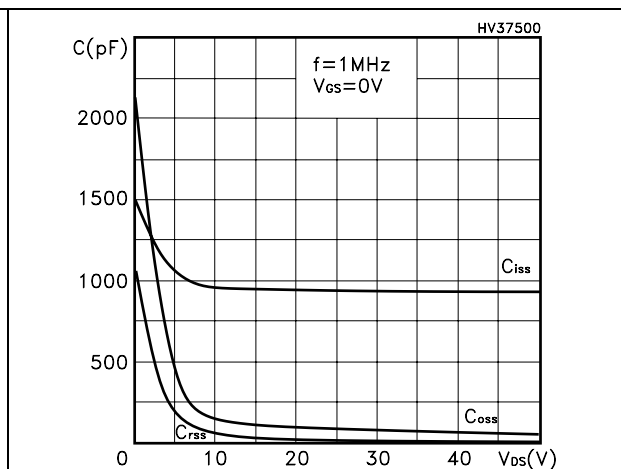

Figure 14. Normalized gate threshold voltage vs. temperature

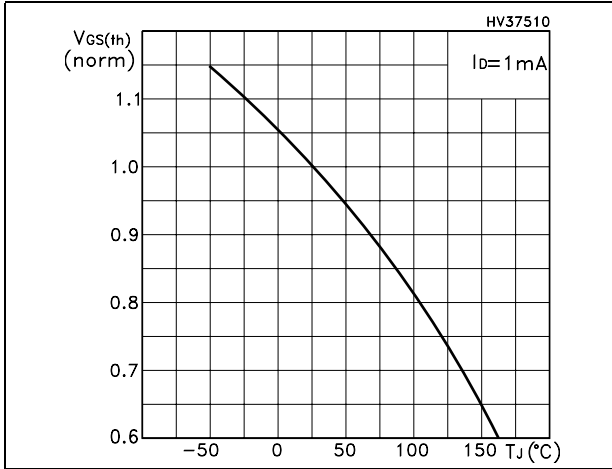

Figure 15. Normalized on resistance vs. temperature

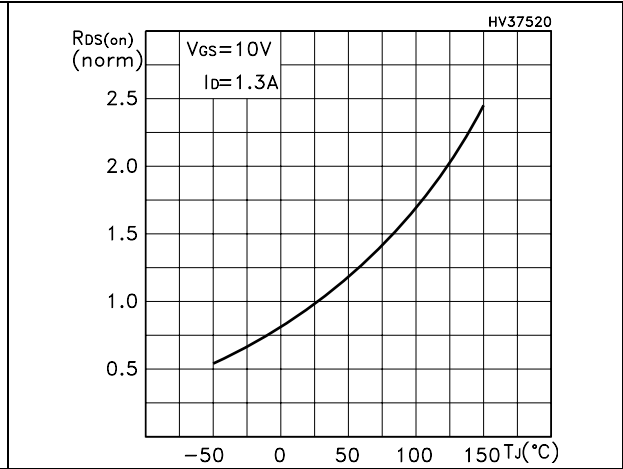

Figure 16. Source-drain diode forward characteristics

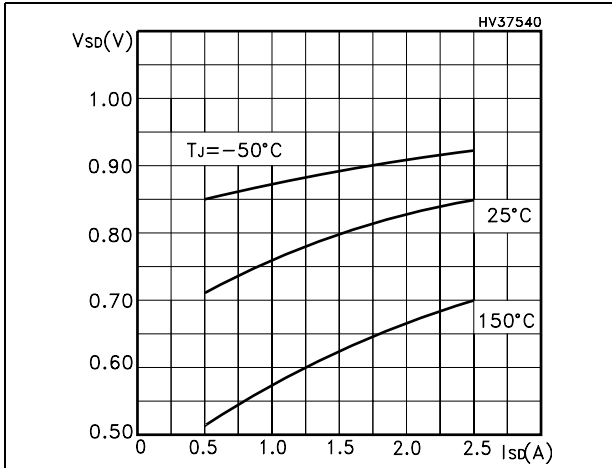
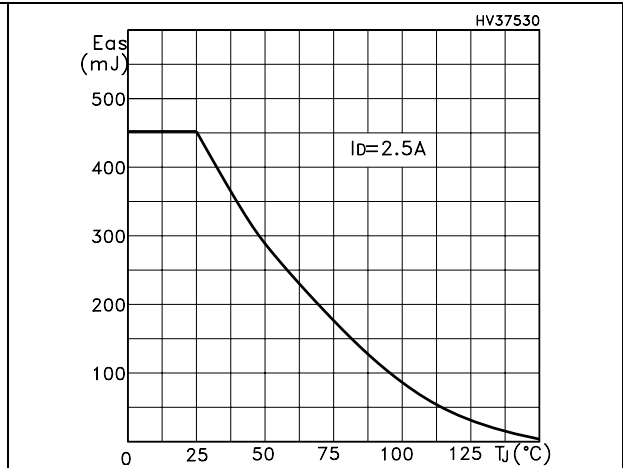

Figure 17. Maximum avalanche energy vs Tj



3 Test circuits

Figure 18. Switching times test circuit for resistive load

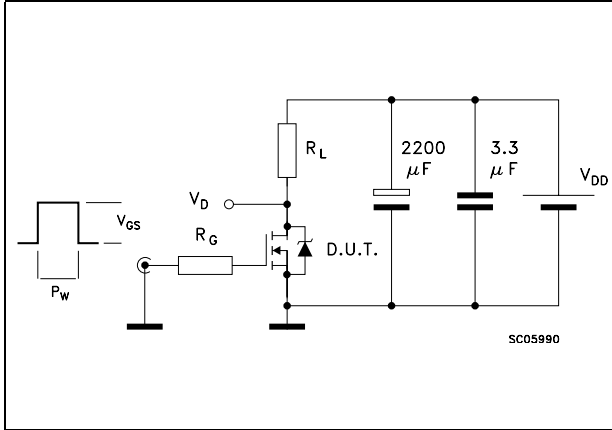

Figure 19. Gate charge test circuit

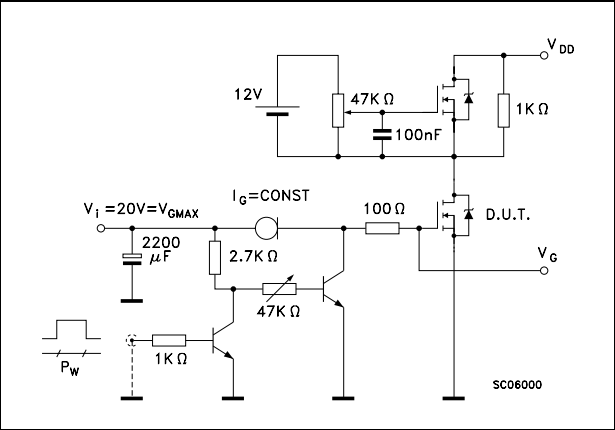

Figure 20. Test circuit for inductive load switching and diode recovery times

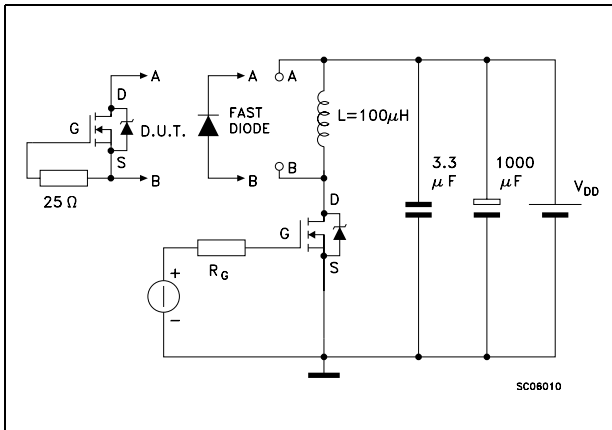

Figure 21. Unclamped inductive load test circuit

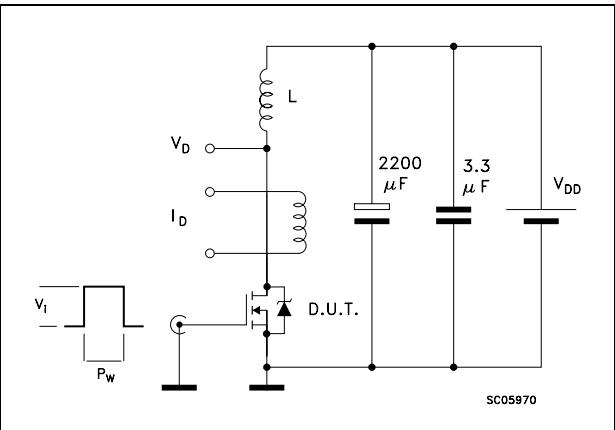

Figure 22. Unclamped inductive waveform

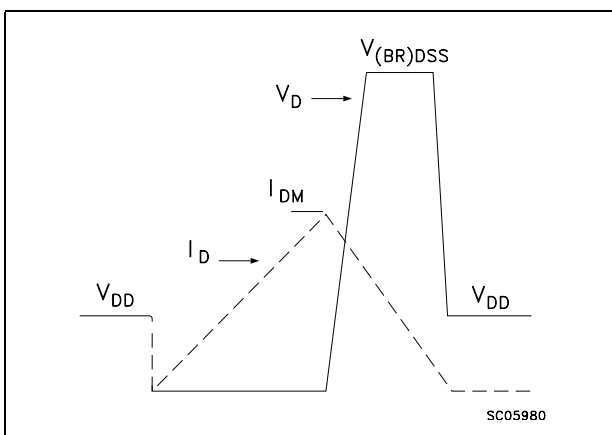
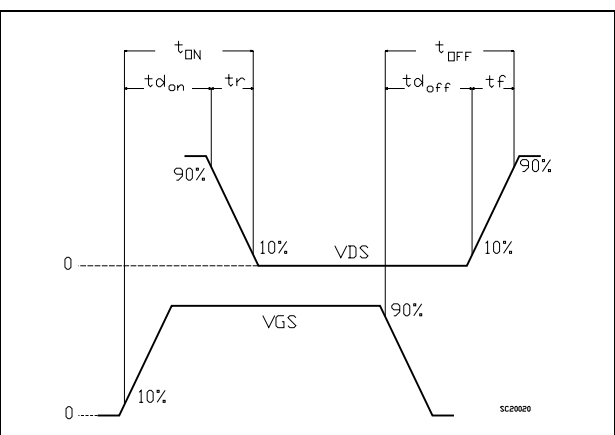

Figure 23. Switching time waveform



4 Package mechanical data

In order to meet environmental requirements, ST offers these devices in different grades of ECOPACK[®] packages, depending on their level of environmental compliance. ECOPACK[®] specifications, grade definitions and product status are available at: www.st.com. ECOPACK is an ST trademark.

TO-247 Mechanical data

Dim.	mm.		
	Min.	Typ	Max.
A	4.85		5.15
A1	2.20		2.60
b	1.0		1.40
b1	2.0		2.40
b2	3.0		3.40
c	0.40		0.80
D	19.85		20.15
E	15.45		15.75
e		5.45	
L	14.20		14.80
L1	3.70		4.30
L2		18.50	
øP	3.55		3.65
øR	4.50		5.50
S		5.50	

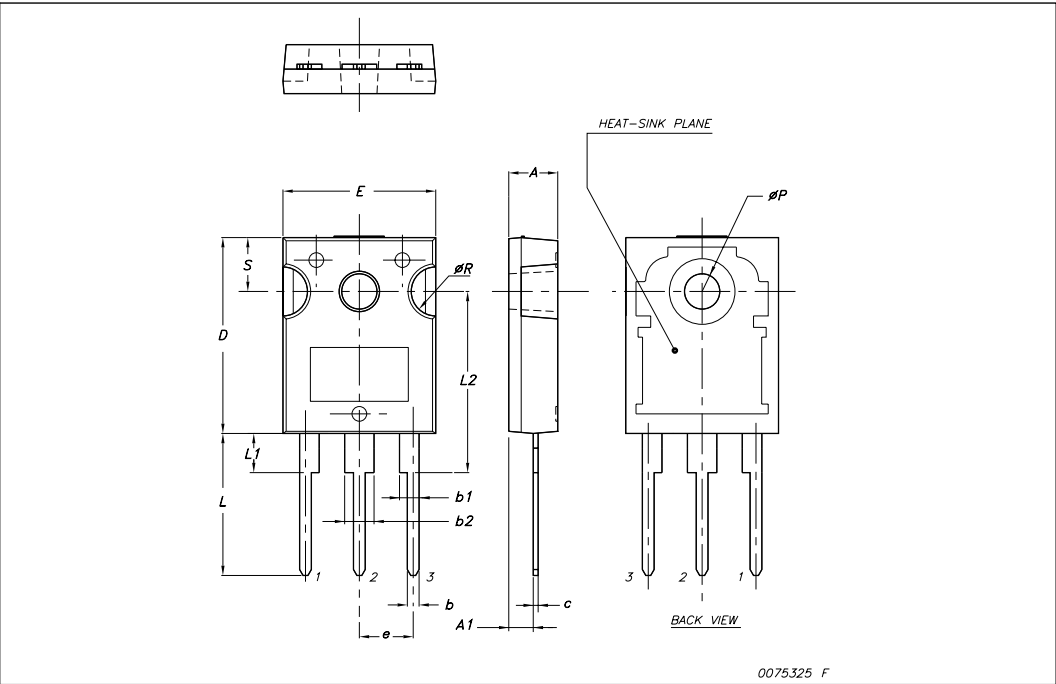

TO-220FH (Fully plastic High voltage) MECHANICAL DATA

DIM.	mm			inch		
	MIN.	TYP.	MAX.	MIN.	TYP.	MAX.
A	4.4		4.6	0.173		0.181
B	2.5		2.7	0.098		0.106
D	2.5		2.75	0.098		0.108
E	0.45		0.7	0.017		0.027
F	0.75		1	0.030		0.039
F1	1.3		1.8	0.051		0.070
F2	1.3		1.8	0.051		0.070
G	4.95		5.2	0.195		0.204
G1	2.4		2.7	0.094		0.106
H	10		10.4	0.393		0.409
L2		16			0.630	
L3	28.6		30.6	1.126		1.204
L4	9.8		10.6	0.385		0.417
L5		3.4			0.134	
L6	15.9		16.4	0.626		0.645
L7	9		9.3	0.354		0.366
L8	14.5		15	0.570		0.590
L9		2.4			0.094	

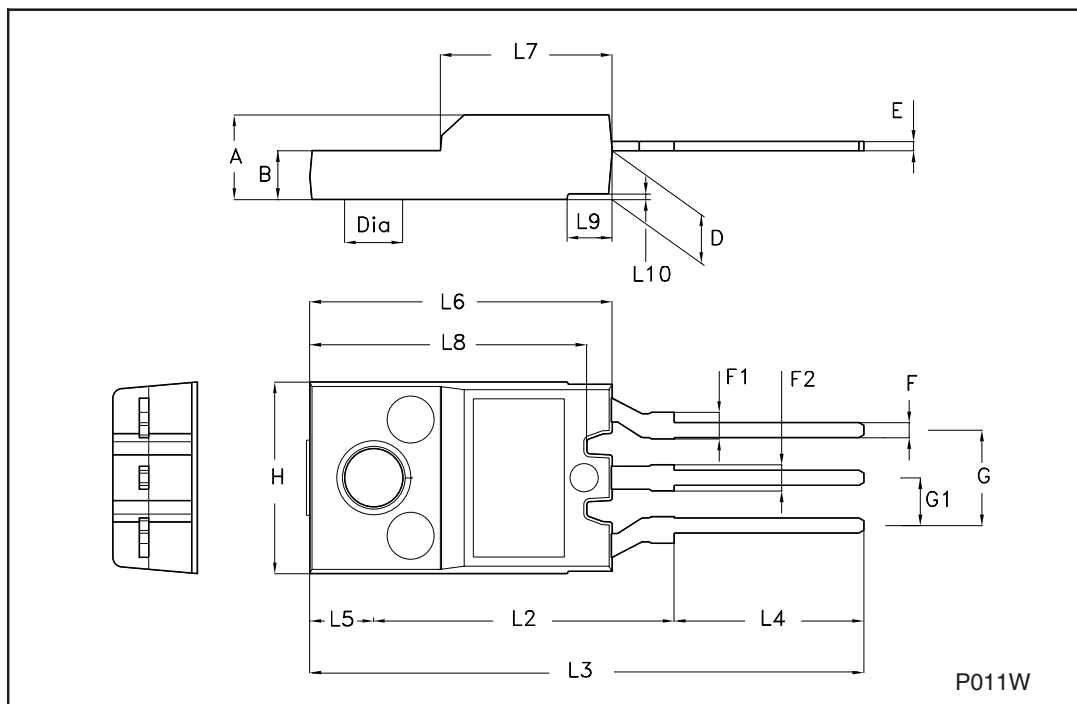

TO-3PF mechanical data

DIM.	mm.		
	min.	typ	max.
A	5.30		5.70
C	2.80		3.20
D	3.10		3.50
D1	1.80		2.20
E	0.80		1.10
F	0.65		0.95
F2	1.80		2.20
G	10.30		11.50
G1		5.45	
H	15.30		15.70
L	9.80	10	10.20
L2	22.80		23.20
L3	26.30		26.70
L4	43.20		44.40
L5	4.30		4.70
L6	24.30		24.70
L7	14.60		15
N	1.80		2.20
R	3.80		4.20
Dia	3.40		3.80

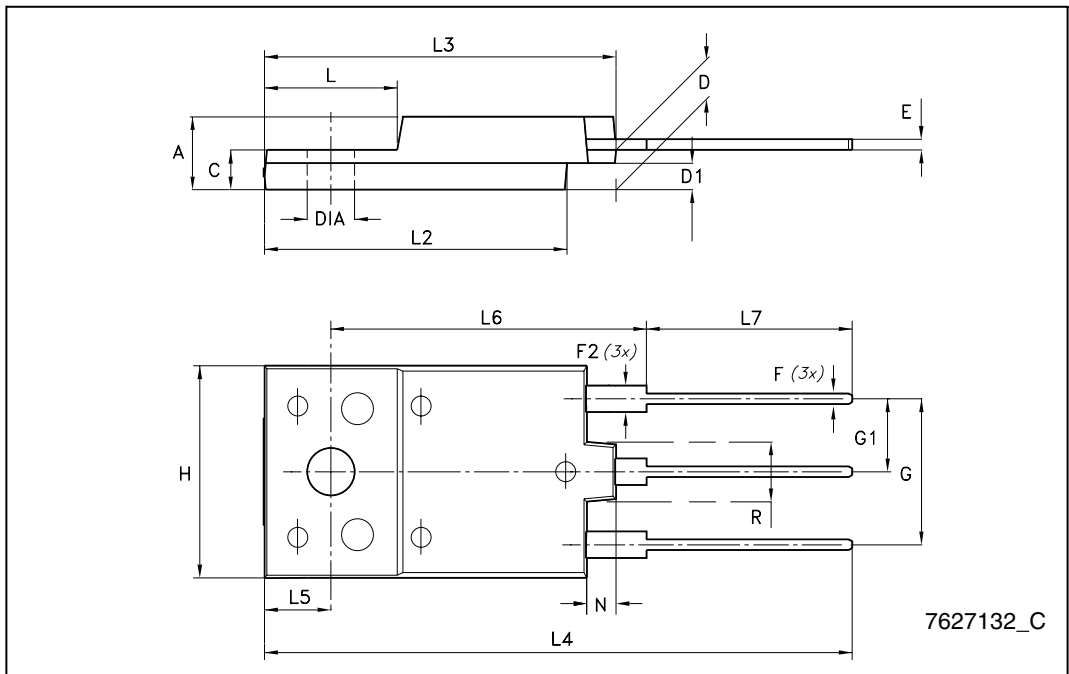

5 Revision history

Table 9. Document revision history

Date	Revision	Changes
12-Jan-2007	1	First release
17-Apr-2007	2	Added new value on Table 6 .
14-May-2007	3	The document has been reformatted
29-Aug-2007	4	$R_{DS(on)}$ value changed, updated Figure 15
09-Apr-2008	5	Added new package: TO-3PF
13-Feb-2009	6	Added P_{TOT} value for TO-3PF (Table 2: Absolute maximum ratings)

Please Read Carefully:

Information in this document is provided solely in connection with ST products. STMicroelectronics NV and its subsidiaries ("ST") reserve the right to make changes, corrections, modifications or improvements, to this document, and the products and services described herein at any time, without notice.

All ST products are sold pursuant to ST's terms and conditions of sale.

Purchasers are solely responsible for the choice, selection and use of the ST products and services described herein, and ST assumes no liability whatsoever relating to the choice, selection or use of the ST products and services described herein.

No license, express or implied, by estoppel or otherwise, to any intellectual property rights is granted under this document. If any part of this document refers to any third party products or services it shall not be deemed a license grant by ST for the use of such third party products or services, or any intellectual property contained therein or considered as a warranty covering the use in any manner whatsoever of such third party products or services or any intellectual property contained therein.

UNLESS OTHERWISE SET FORTH IN ST'S TERMS AND CONDITIONS OF SALE ST DISCLAIMS ANY EXPRESS OR IMPLIED WARRANTY WITH RESPECT TO THE USE AND/OR SALE OF ST PRODUCTS INCLUDING WITHOUT LIMITATION IMPLIED WARRANTIES OF MERCHANTABILITY, FITNESS FOR A PARTICULAR PURPOSE (AND THEIR EQUIVALENTS UNDER THE LAWS OF ANY JURISDICTION), OR INFRINGEMENT OF ANY PATENT, COPYRIGHT OR OTHER INTELLECTUAL PROPERTY RIGHT.

UNLESS EXPRESSLY APPROVED IN WRITING BY AN AUTHORIZED ST REPRESENTATIVE, ST PRODUCTS ARE NOT RECOMMENDED, AUTHORIZED OR WARRANTED FOR USE IN MILITARY, AIR CRAFT, SPACE, LIFE SAVING, OR LIFE SUSTAINING APPLICATIONS, NOR IN PRODUCTS OR SYSTEMS WHERE FAILURE OR MALFUNCTION MAY RESULT IN PERSONAL INJURY, DEATH, OR SEVERE PROPERTY OR ENVIRONMENTAL DAMAGE. ST PRODUCTS WHICH ARE NOT SPECIFIED AS "AUTOMOTIVE GRADE" MAY ONLY BE USED IN AUTOMOTIVE APPLICATIONS AT USER'S OWN RISK.

Resale of ST products with provisions different from the statements and/or technical features set forth in this document shall immediately void any warranty granted by ST for the ST product or service described herein and shall not create or extend in any manner whatsoever, any liability of ST.

ST and the ST logo are trademarks or registered trademarks of ST in various countries.

Information in this document supersedes and replaces all information previously supplied.

The ST logo is a registered trademark of STMicroelectronics. All other names are the property of their respective owners.

© 2009 STMicroelectronics - All rights reserved

STMicroelectronics group of companies

Australia - Belgium - Brazil - Canada - China - Czech Republic - Finland - France - Germany - Hong Kong - India - Israel - Italy - Japan - Malaysia - Malta - Morocco - Singapore - Spain - Sweden - Switzerland - United Kingdom - United States of America

www.st.com