



# 55GN01FA

## RF Transistor

10V, 70mA,  $f_T=5.5\text{GHz}$ , NPN Single SSFP

ON Semiconductor®

<http://onsemi.com>

### Features

- High cut-off frequency :  $f_T=5.5\text{GHz}$  typ
- High gain :  $|S_{21e}|^2=11\text{dB}$  typ ( $f=1\text{GHz}$ )  
 $=19\text{dB}$  typ ( $f=400\text{MHz}$ )
- Ultrasmall package permitting applied sets to be small and slim
- Halogen free compliance

### Specifications

Absolute Maximum Ratings at  $T_a=25^\circ\text{C}$

Parameter	Symbol	Conditions	Ratings	Unit
Collector-to-Base Voltage	$V_{CBO}$		20	V
Collector-to-Emitter Voltage	$V_{CEO}$		10	V
Emitter-to-Base Voltage	$V_{EBO}$		3	V
Collector Current	$I_C$		70	mA
Collector Dissipation	$P_C$		250	mW
Junction Temperature	$T_j$		150	$^\circ\text{C}$
Storage Temperature	$T_{stg}$		-55 to +150	$^\circ\text{C}$

Stresses exceeding Maximum Ratings may damage the device. Maximum Ratings are stress ratings only. Functional operation above the Recommended Operating Conditions is not implied. Extended exposure to stresses above the Recommended Operating Conditions may affect device reliability.

### Package Dimensions

unit : mm (typ)

7029A-002

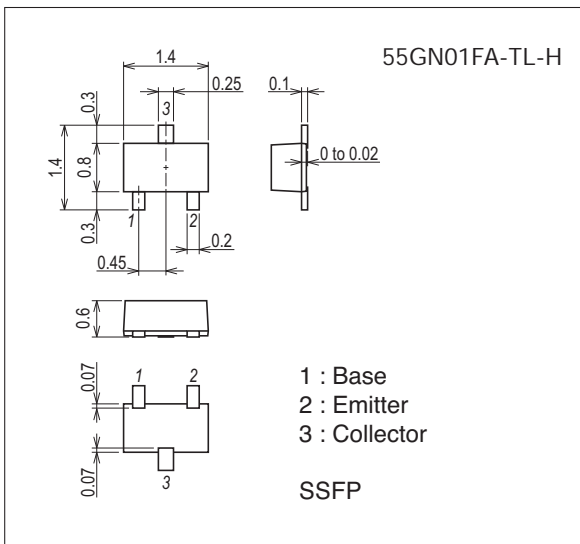

### Product & Package Information

- Package : SSFP
- JEITA, JEDEC : SC-81
- Minimum Packing Quantity : 8,000 pcs./reel

### Packing Type: TL

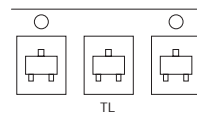

### Marking

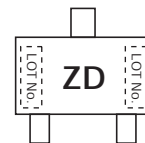

### Electrical Connection

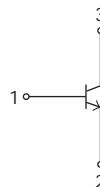

# 55GN01FA

## Electrical Characteristics at Ta=25°C

Parameter	Symbol	Conditions	Ratings			Unit
			min	typ	max	
Collector Cutoff Current	$I_{CBO}$	$V_{CB}=10V, I_E=0A$			0.1	$\mu A$
Emitter Cutoff Current	$I_{EBO}$	$V_{EB}=2V, I_C=0A$			1	$\mu A$
DC Current Gain	$h_{FE}$	$V_{CE}=5V, I_C=10mA$	100		160	
Gain-Bandwidth Product	$f_{T1}$	$V_{CE}=3V, I_C=5mA$	3.0	4.5		GHz
	$f_{T2}$	$V_{CE}=5V, I_C=20mA$		5.5		GHz
Output Capacitance	$C_{ob}$	$V_{CB}=10V, f=1MHz$		0.95	1.2	pF
Reverse Transfer Capacitance	$C_{re}$				0.6	pF
Forward Transfer Gain	$ S_{21e} ^2_1$	$V_{CE}=5V, I_C=20mA, f=1GHz$	8	11		dB
	$ S_{21e} ^2_2$	$V_{CE}=5V, I_C=20mA, f=400MHz$	16	19		dB
Noise Figure	NF	$V_{CE}=3V, I_C=5mA, f=1GHz, Z_S=Z_L=50\Omega$		1.9		dB

## Ordering Information

Device	Package	Shipping	memo
55GN01FA-TL-H	SSFP	8,000pcs./reel	Pb Free and Halogen Free

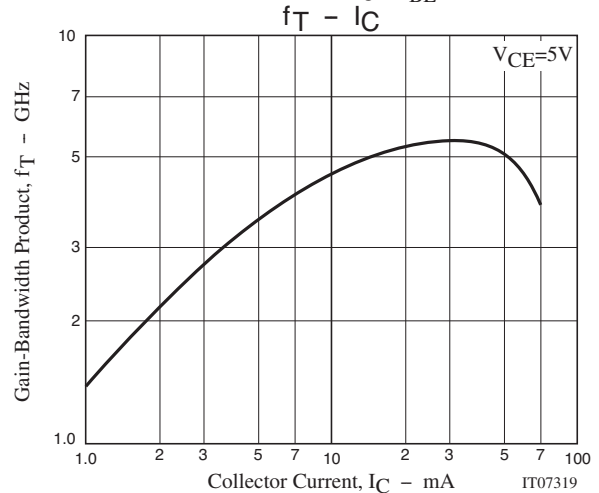
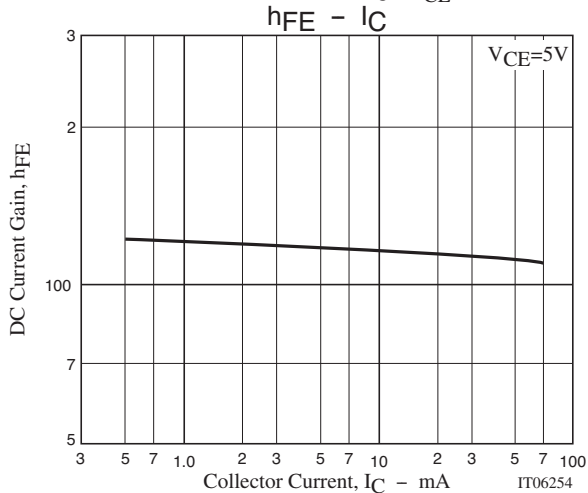
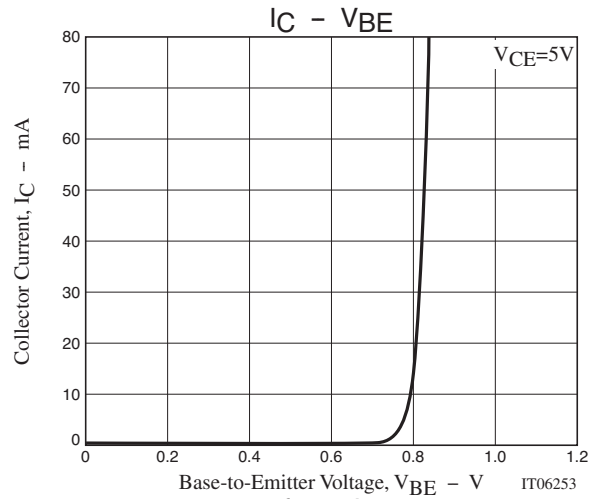
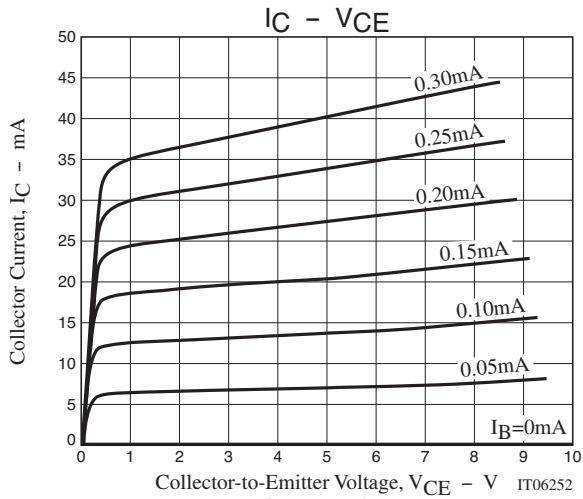

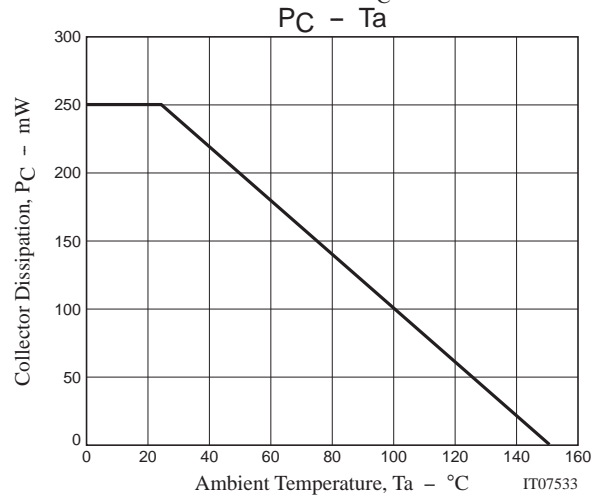
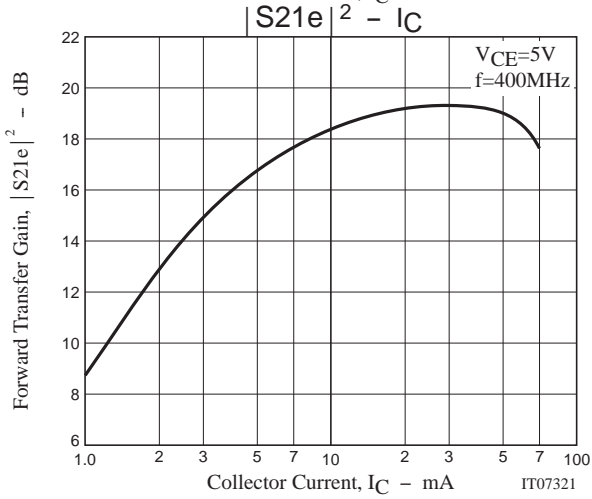
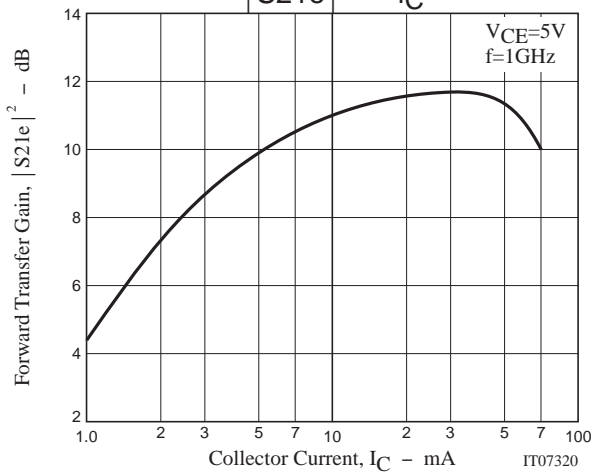
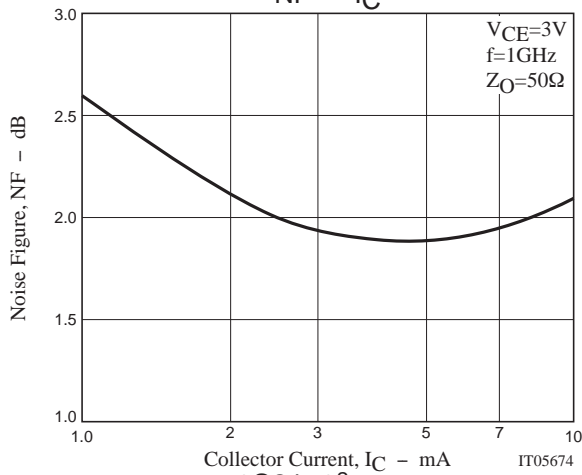
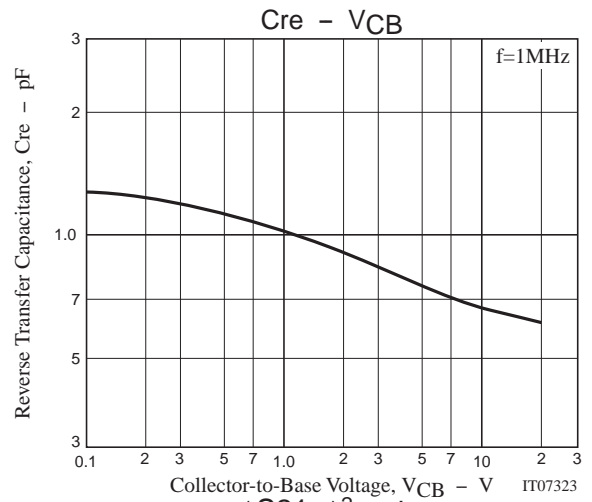
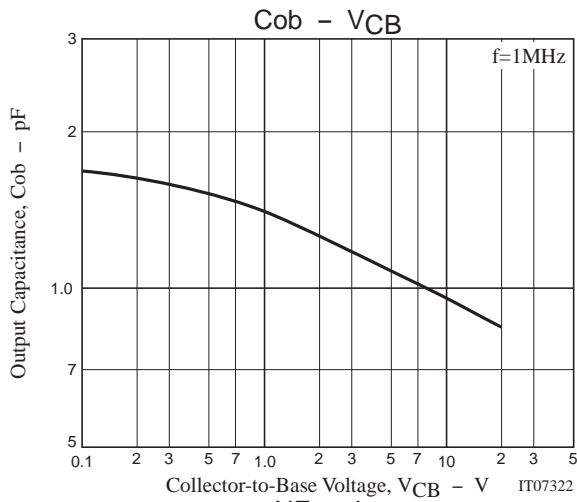

# 55GN01FA

## S Parameters (Common emitter)

$V_{CE}=5V, I_C=1mA, Z_O=50\Omega$

Freq(MHz)	S11	$\angle S11$	S21	$\angle S21$	S12	$\angle S12$	S22	$\angle S22$
100	0.960	-21.33	3.404	164.99	0.046	77.57	0.986	-9.38
200	0.943	-40.21	3.215	151.43	0.085	64.91	0.938	-18.56
400	0.888	-72.87	2.700	128.23	0.139	46.91	0.838	-31.44
600	0.853	-97.36	2.288	110.64	0.167	34.66	0.757	-40.30
800	0.816	-115.67	1.926	96.26	0.179	26.17	0.706	-46.95
1000	0.788	-129.19	1.659	84.81	0.180	19.95	0.676	-52.20
1200	0.767	-140.35	1.451	74.89	0.174	16.50	0.664	-56.92
1400	0.749	-149.12	1.286	66.48	0.168	14.89	0.662	-61.86
1600	0.734	-156.38	1.162	59.19	0.160	14.19	0.668	-66.10
1800	0.719	-163.17	1.061	52.60	0.149	15.77	0.677	-70.98
2000	0.705	-169.31	0.977	46.28	0.141	19.10	0.683	-75.24
2200	0.694	-174.71	0.893	41.12	0.136	24.16	0.695	-79.81
2400	0.683	-179.60	0.825	36.38	0.135	30.74	0.705	-84.33
2600	0.675	-174.53	0.765	32.38	0.141	38.01	0.717	-88.85
2800	0.664	-169.68	0.709	29.26	0.149	45.42	0.729	-93.41
3000	0.653	-165.11	0.667	26.87	0.163	51.07	0.737	-97.77

$V_{CE}=5V, I_C=3mA, Z_O=50\Omega$

Freq(MHz)	S11	$\angle S11$	S21	$\angle S21$	S12	$\angle S12$	S22	$\angle S22$
100	0.897	-35.17	8.858	157.25	0.044	71.22	0.940	-17.73
200	0.846	-64.07	7.795	138.86	0.073	55.30	0.816	-31.57
400	0.761	-104.22	5.532	114.15	0.100	39.30	0.626	-45.72
600	0.727	-127.47	4.177	99.10	0.110	33.80	0.530	-52.62
800	0.698	-142.65	3.306	87.99	0.115	31.00	0.483	-57.50
1000	0.681	-152.69	2.715	79.36	0.120	30.86	0.461	-61.55
1200	0.670	-160.54	2.308	72.11	0.121	33.53	0.456	-65.03
1400	0.656	-166.79	2.012	65.45	0.124	35.60	0.461	-69.34
1600	0.647	-172.10	1.793	59.66	0.130	38.30	0.468	-72.55
1800	0.635	-176.87	1.621	54.21	0.135	41.86	0.479	-76.57
2000	0.628	-178.54	1.481	48.73	0.144	45.68	0.490	-80.11
2200	0.616	-173.99	1.351	44.05	0.153	48.13	0.501	-83.71
2400	0.611	-169.80	1.246	39.67	0.167	50.77	0.518	-87.42
2600	0.601	-166.00	1.157	35.62	0.178	53.54	0.528	-91.49
2800	0.597	-162.06	1.079	32.28	0.196	55.92	0.543	-95.09
3000	0.588	-158.02	1.015	29.15	0.215	56.86	0.555	-98.59

$V_{CE}=5V, I_C=5mA, Z_O=50\Omega$

Freq(MHz)	S11	$\angle S11$	S21	$\angle S21$	S12	$\angle S12$	S22	$\angle S22$
100	0.842	-46.44	13.174	151.15	0.040	64.28	0.891	-24.16
200	0.777	-81.34	10.723	130.44	0.062	50.01	0.716	-39.59
400	0.699	-121.57	6.861	106.89	0.080	39.73	0.508	-52.96
600	0.679	-141.39	4.942	94.02	0.089	37.45	0.424	-58.67
800	0.661	-153.84	3.830	84.43	0.096	38.27	0.390	-62.90
1000	0.648	-162.04	3.117	77.09	0.103	40.59	0.376	-66.27
1200	0.641	-168.02	2.643	70.51	0.111	43.94	0.374	-69.52
1400	0.629	-173.53	2.286	64.60	0.120	46.56	0.382	-73.45
1600	0.620	-177.70	2.039	59.33	0.130	48.48	0.390	-76.69
1800	0.610	-177.97	1.841	54.24	0.139	50.63	0.400	-79.97
2000	0.603	-173.76	1.676	49.26	0.153	53.08	0.413	-83.21
2200	0.594	-169.87	1.528	44.84	0.167	53.92	0.426	-86.71
2400	0.588	-166.14	1.413	40.43	0.181	55.16	0.441	-89.93
2600	0.580	-162.49	1.313	36.57	0.195	56.19	0.453	-93.54
2800	0.576	-158.82	1.231	33.47	0.213	57.85	0.466	-96.88
3000	0.565	-155.09	1.156	30.12	0.232	57.84	0.481	-99.87

## 55GN01FA

### S Parameters (Common emitter)

$V_{CE}=5V, I_C=10mA, Z_0=50\Omega$

Freq(MHz)	S11	$\angle S11$	S21	$\angle S21$	S12	$\angle S12$	S22	$\angle S22$
100	0.739	-68.53	20.705	140.20	0.033	59.97	0.784	-35.06
200	0.678	-107.92	14.465	118.48	0.048	46.54	0.555	-51.65
400	0.639	-142.44	8.256	98.88	0.060	44.77	0.362	-62.32
600	0.636	-156.46	5.721	88.62	0.070	47.35	0.306	-66.66
800	0.628	-165.41	4.393	80.84	0.082	51.17	0.286	-70.68
1000	0.620	-171.30	3.549	74.44	0.094	53.84	0.280	-73.86
1200	0.615	-176.02	2.981	68.87	0.108	55.37	0.285	-76.55
1400	0.606	179.70	2.584	63.58	0.121	57.13	0.297	-80.44
1600	0.599	176.38	2.298	58.72	0.134	58.54	0.307	-83.02
1800	0.589	173.12	2.065	54.21	0.149	58.63	0.319	-86.36
2000	0.586	169.27	1.889	49.40	0.165	59.48	0.329	-88.76
2200	0.573	165.75	1.719	45.30	0.179	59.22	0.344	-91.59
2400	0.567	162.49	1.589	41.42	0.195	59.66	0.362	-94.36
2600	0.562	158.91	1.481	37.55	0.211	59.11	0.374	-97.29
2800	0.558	155.91	1.385	34.30	0.229	59.13	0.388	-100.28
3000	0.548	152.46	1.310	31.07	0.248	58.50	0.400	-102.49

$V_{CE}=5V, I_C=15mA, Z_0=50\Omega$

Freq(MHz)	S11	$\angle S11$	S21	$\angle S21$	S12	$\angle S12$	S22	$\angle S22$
100	0.680	-83.50	24.897	133.56	0.029	56.21	0.704	-41.82
200	0.639	-122.13	16.056	112.77	0.040	47.85	0.468	-57.53
400	0.621	-151.34	8.769	95.48	0.052	50.10	0.300	-67.15
600	0.623	-162.54	6.015	86.49	0.064	53.63	0.258	-70.98
800	0.620	-170.29	4.606	79.25	0.079	57.27	0.244	-74.71
1000	0.611	-175.21	3.708	73.36	0.093	58.61	0.243	-78.49
1200	0.606	-179.14	3.121	67.87	0.107	60.22	0.249	-80.66
1400	0.599	176.96	2.697	63.02	0.122	61.45	0.262	-84.17
1600	0.593	174.14	2.394	58.44	0.138	61.14	0.275	-86.76
1800	0.584	170.85	2.158	54.02	0.153	61.15	0.287	-89.61
2000	0.577	167.75	1.973	49.36	0.168	61.74	0.298	-91.80
2200	0.569	164.22	1.790	45.54	0.184	61.18	0.314	-94.29
2400	0.564	160.80	1.659	41.46	0.201	60.23	0.330	-97.05
2600	0.556	157.53	1.542	37.83	0.216	60.12	0.342	-99.52
2800	0.552	154.68	1.446	34.40	0.234	59.34	0.352	-101.94
3000	0.543	151.47	1.361	31.44	0.253	58.86	0.366	-103.99

$V_{CE}=5V, I_C=20mA, Z_0=50\Omega$

Freq(MHz)	S11	$\angle S11$	S21	$\angle S21$	S12	$\angle S12$	S22	$\angle S22$
100	0.641	-94.49	27.471	128.94	0.027	55.26	0.649	-46.11
200	0.620	-130.76	16.818	109.44	0.036	46.79	0.413	-61.30
400	0.615	-156.41	9.019	93.57	0.048	53.11	0.265	-70.11
600	0.619	-165.97	6.162	85.24	0.062	57.92	0.228	-73.77
800	0.615	-172.83	4.701	78.51	0.078	61.14	0.223	-77.54
1000	0.608	-177.23	3.787	72.80	0.092	61.33	0.223	-81.02
1200	0.605	179.19	3.189	67.44	0.108	63.68	0.231	-83.24
1400	0.597	175.70	2.755	62.79	0.123	63.07	0.245	-86.33
1600	0.590	172.88	2.442	58.12	0.138	62.89	0.255	-88.33
1800	0.581	169.98	2.201	53.81	0.156	63.03	0.272	-91.87
2000	0.578	166.61	2.013	49.41	0.172	62.58	0.281	-93.44
2200	0.567	163.21	1.834	45.29	0.187	61.81	0.298	-95.50
2400	0.564	160.39	1.691	41.48	0.204	61.15	0.311	-98.00
2600	0.556	157.07	1.572	37.96	0.218	61.01	0.326	-100.45
2800	0.552	153.99	1.478	34.76	0.239	59.99	0.337	-102.57
3000	0.544	151.04	1.389	31.49	0.256	58.80	0.349	-104.89

## 55GN01FA

### S Parameters (Common emitter)

$V_{CE}=5V, I_C=30mA, Z_O=50\Omega$

Freq(MHz)	S11	$\angle S11$	S21	$\angle S21$	S12	$\angle S12$	S22	$\angle S22$
100	0.606	-108.75	29.954	123.54	0.022	52.56	0.574	-51.26
200	0.604	-140.73	17.448	105.68	0.031	50.23	0.355	-64.86
400	0.610	-161.95	9.185	91.52	0.044	57.91	0.229	-71.81
600	0.617	-169.73	6.244	83.80	0.061	62.49	0.202	-74.91
800	0.612	-175.60	4.752	77.41	0.077	64.49	0.201	-79.23
1000	0.608	-179.42	3.833	71.88	0.091	66.02	0.204	-82.01
1200	0.604	177.51	3.213	66.72	0.108	65.81	0.214	-84.26
1400	0.598	174.16	2.786	62.07	0.124	64.91	0.229	-87.74
1600	0.591	171.45	2.465	57.60	0.141	64.74	0.242	-89.81
1800	0.584	168.71	2.221	53.24	0.156	64.27	0.255	-92.03
2000	0.582	165.57	2.027	48.84	0.173	63.95	0.266	-93.76
2200	0.569	162.47	1.842	44.77	0.189	62.96	0.281	-96.01
2400	0.566	159.27	1.707	41.02	0.205	62.39	0.298	-98.15
2600	0.560	156.39	1.589	37.71	0.221	61.62	0.312	-100.74
2800	0.555	153.39	1.489	34.29	0.241	60.71	0.324	-103.01
3000	0.546	150.41	1.401	31.06	0.260	59.58	0.339	-104.84

$V_{CE}=5V, I_C=50mA, Z_O=50\Omega$

Freq(MHz)	S11	$\angle S11$	S21	$\angle S21$	S12	$\angle S12$	S22	$\angle S22$
100	0.587	-124.93	30.667	118.01	0.020	53.81	0.493	-53.52
200	0.607	-151.01	17.135	101.95	0.027	56.26	0.302	-62.86
400	0.618	-167.42	8.863	89.36	0.042	61.87	0.204	-65.99
600	0.625	-173.36	6.015	82.09	0.057	67.05	0.188	-69.08
800	0.625	-178.39	4.579	75.84	0.073	68.51	0.192	-73.08
1000	0.621	178.24	3.676	70.38	0.090	67.50	0.200	-76.57
1200	0.617	175.49	3.102	65.41	0.106	67.96	0.213	-79.88
1400	0.611	172.50	2.675	60.74	0.123	67.75	0.228	-83.13
1600	0.605	170.02	2.371	56.11	0.138	67.29	0.245	-85.73
1800	0.598	167.32	2.131	51.76	0.155	65.91	0.261	-88.36
2000	0.594	164.43	1.944	47.33	0.173	65.72	0.273	-90.18
2200	0.587	161.08	1.771	43.20	0.189	64.76	0.291	-93.08
2400	0.582	158.20	1.636	39.59	0.204	63.82	0.308	-95.85
2600	0.575	155.22	1.517	36.00	0.222	63.08	0.325	-98.58
2800	0.571	151.88	1.420	32.74	0.241	62.62	0.341	-100.91
3000	0.564	149.04	1.345	29.50	0.259	61.30	0.351	-102.73

Embossed Taping Specification

55GN01FA-TL-H

1. Packing Format

Package Name	Carrier Tape Type	Maximum Number of devices contained (pcs)			Packing format	
		Reel	Inner box	Outer box	Inner BOX (C-1)	Outer BOX (A-7)
SSFP	SSFP	8,000	40,000	240,000	5 reels contained Dimensions:mm (external) 183×72×185	6 inner boxes contained Dimensions:mm (external) 440×195×210

Packing method

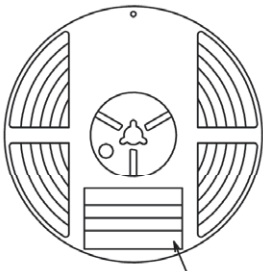

Reel label

Reel label, Inner box label  
(unit:mm)

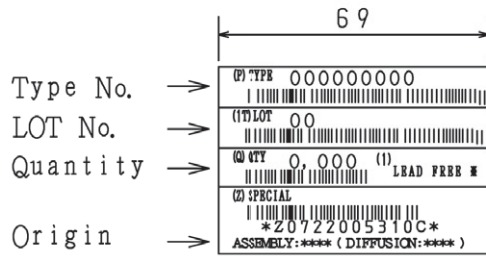

Outer box label

It is a label at the time of factory shipments. The form of a label may change in physical distribution process.

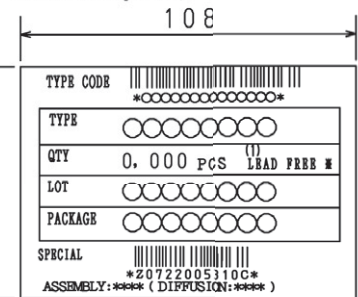

NOTE (1)

The LEAD FREE \* description shows that the surface treatment of the terminal is lead free.

Label	JEITA Phase
LEAD FREE 3	JEITA Phase 3A
LEAD FREE 4	JEITA Phase 3

2. Taping configuration

2-1. Carrier tape size (unit:mm)

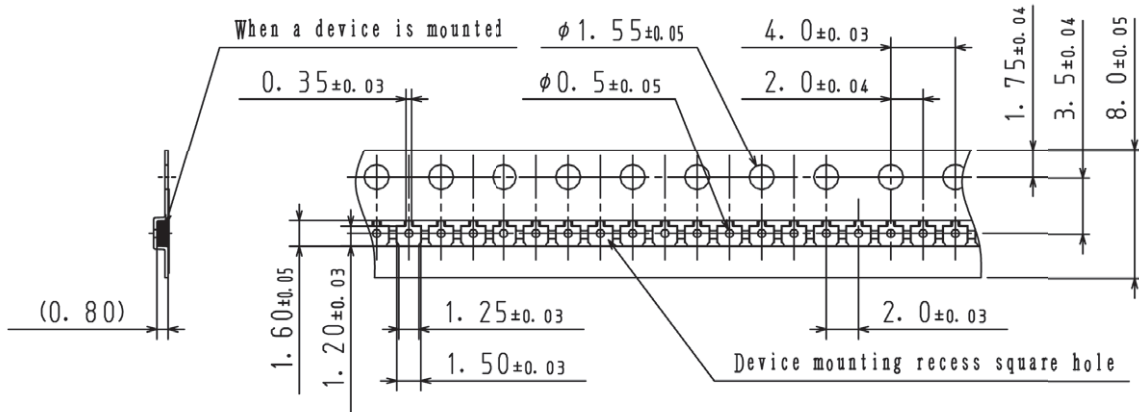

2-2. Device placement direction

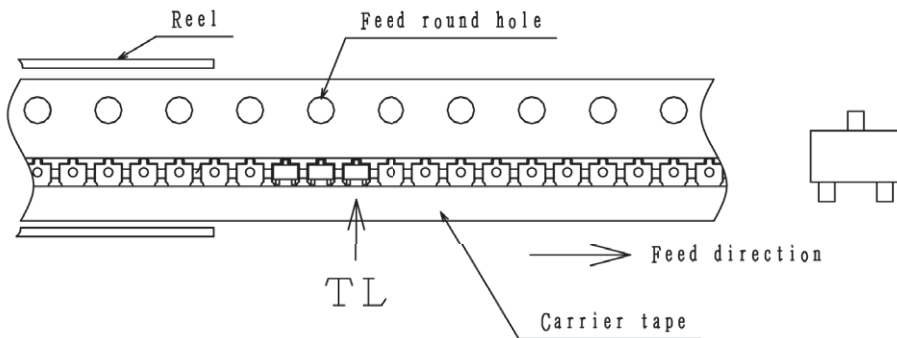

Those with pin 1 index on the feed hole side.....TL

# 55GN01FA

## Outline Drawing 55GN01FA-TL-H

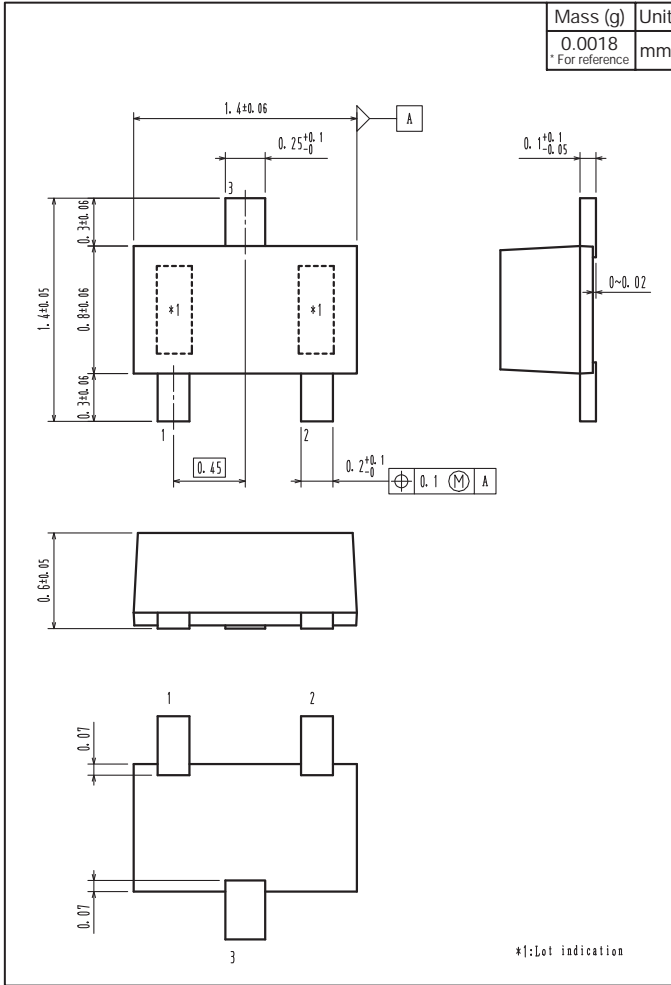

## Land Pattern Example

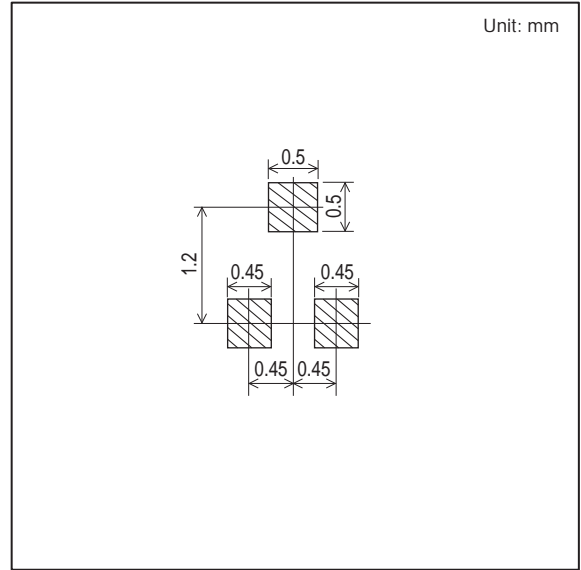



ON Semiconductor and the ON logo are registered trademarks of Semiconductor Components Industries, LLC (SCILLC). SCILLC owns the rights to a number of patents, trademarks, copyrights, trade secrets, and other intellectual property. A listing of SCILLC's product/patent coverage may be accessed at [www.onsemi.com/site/pdf/Patent-Marking.pdf](http://www.onsemi.com/site/pdf/Patent-Marking.pdf). SCILLC reserves the right to make changes without further notice to any products herein. SCILLC makes no warranty, representation or guarantee regarding the suitability of its products for any particular purpose, nor does SCILLC assume any liability arising out of the application or use of any product or circuit, and specifically disclaims any and all liability, including without limitation special, consequential or incidental damages. "Typical" parameters which may be provided in SCILLC data sheets and/or specifications can and do vary in different applications and actual performance may vary over time. All operating parameters, including "Typicals" must be validated for each customer application by customer's technical experts. SCILLC does not convey any license under its patent rights nor the rights of others. SCILLC products are not designed, intended, or authorized for use as components in systems intended for surgical implant into the body, or other applications intended to support or sustain life, or for any other application in which the failure of the SCILLC product could create a situation where personal injury or death may occur. Should Buyer purchase or use SCILLC products for any such unintended or unauthorized application, Buyer shall indemnify and hold SCILLC and its officers, employees, subsidiaries, affiliates, and distributors harmless against all claims, costs, damages, and expenses, and reasonable attorney fees arising out of, directly or indirectly, any claim of personal injury or death associated with such unintended or unauthorized use, even if such claim alleges that SCILLC was negligent regarding the design or manufacture of the part. SCILLC is an Equal Opportunity/Affirmative Action Employer. This literature is subject to all applicable copyright laws and is not for resale in any manner.