

**FEATURES**

**Converter and Evaluation Development (EVAL-CED1Z) compatibility**

**Versatile analog signal conditioning circuitry**

**On-board reference, clock oscillator and buffers**

**PC software for control and data analysis of time and frequency domain**

**Stand alone operation**

**GENERAL DESCRIPTION**

The EVAL-AD76MUXCBZ is an evaluation board for the 20 lead PulSAR AD7682, AD7689, AD7699, and AD7949 14-bit and 16-bit PulSAR analog to digital converter (ADC) family. These low power, successive approximation register (SAR) architecture ADCs (see Ordering Guide for product list) offer very high performance with up to 500kSPS throughput rate and 4 – 8 channels. The evaluation board is designed to demonstrate the ADC's performance and to provide an easy to understand interface for a variety of system applications. A full description of the AD7682, AD7689, AD7699, and AD7949 is available in at

[www.analog.com](http://www.analog.com) and should be consulted when utilizing this evaluation board.

The evaluation board can be operated as a stand alone or can be used in conjunction with the Analog Devices EVAL-CED1Z (CED) USB based data capture board. Since the ADC's being evaluated are serial interface only, the EVAL-AD76MUXCBZ contains the necessary logic to perform serial to parallel conversion for this interface using the on board FPGA.

On-board components include a high precision band gap reference, (ADR435), reference buffers, 8-signal conditioning circuits with an op amp and an FPGA for digital logic. Also included are separate low drop out regulators for supplying special voltages of 1.2V and 7V which are not available from the EVAL-CED1Z.

The board interfaces to the EVAL-CED1Z with a 96-pin DIN connector. J1, J2 SMB connectors are provided for the low noise analog signal source for CH0 and CH1 with the remaining channels (and CH0/1) available on an IDC connector, P1. J3 can be used for providing an external common (COM) or configured for any input channel.

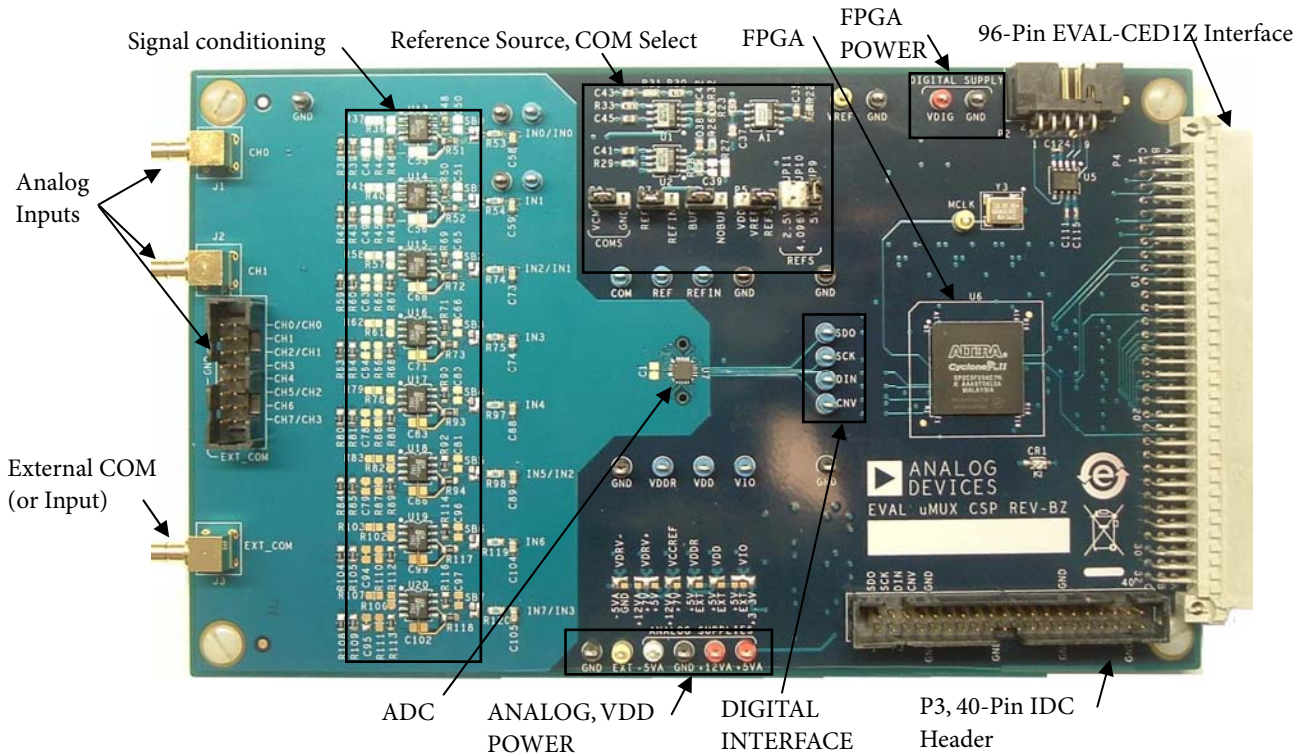

Figure 1. Evaluation Board

**Rev. PrD**

Information furnished by Analog Devices is believed to be accurate and reliable. However, no responsibility is assumed by Analog Devices for its use, nor for any infringements of patents or other rights of third parties that may result from its use. Specifications subject to change without notice. No license is granted by implication or otherwise under any patent or patent rights of Analog Devices. Trademarks and registered trademarks are the property of their respective owners.

**TABLE OF CONTENTS**

Features ..... 1  
 Revision History ..... 2  
     Overview..... 3  
     Conversion Control..... 3  
     Analog Inputs..... 3  
     Serial Interface ..... 3  
     Reference ..... 3  
     Power Supplies and Grounding ..... 3  
     Schematics/PCB Layout..... 4  
     Hardware Setup ..... 4

Software Installation .....4  
 Running the Evaluation Software .....5  
 Setup Screen .....5  
 Configuring the ADC .....5  
 DC Testing - Histogram .....5  
 AC Testing .....5  
 Software Operation .....8  
 ADC Configuration .....9  
 Evaluation Board Schematics and Artwork ..... 15  
 Ordering Guide ..... 26

**LIST OF FIGURES**

Figure 1.Evaluation Board ..... 1  
 Figure 2. Setup Screen ..... 8  
 Figure 3. Default CFG ..... 9  
 Figure 4. CGF Enable/Disable Selection..... 9  
 Figure 5. Input Configuration/Channel Selection..... 9  
 Figure 6.BW Select..... 9  
 Figure 7. Reference Selection ..... 9  
 Figure 8. Context Help, User Controls ..... 10  
 Figure 9. Histogram Screen ..... 11  
 Figure 10. Summary ..... 12  
 Figure 11. FFT Spectrum ..... 13  
 Figure 12 .Oscilloscope ..... 14  
 Figure 13. Schematic, ADC + Block Diagram..... 15

Figure 14. Schematic, Supplies ..... 16  
 Figure 15. Schematic, Reference, Buffer,  $V_{CM}$ ,  $V_{BIAS}$  ..... 17  
 Figure 16. Schematic, AnalogCH0-CH3..... 18  
 Figure 17. Schematic, AnalogCH4-CH7..... 19  
 Figure 18. Schematic, FPGA..... 20  
 Figure 19. Schematic, 96-Pin Interface ..... 21  
 Figure 20. Top Side Silk-Screen ..... 22  
 Figure 21. Inner Layer 1 ..... 22  
 Figure 22. Ground Plane ..... 23  
 Figure 23. Inner Layer 2..... 23  
 Figure 24.Inner Layer 3..... 24  
 Figure 25. Bottom Layer ..... 24  
 Figure 26. Bottom Layer ..... 25

**LIST OF TABLES**

Table 1. Jumper Description..... 6  
 Table 2.Test Points ..... 7

Table 3. Bill of Materials for the Connectors .....7

**REVISION HISTORY**

## OVERVIEW

Figure 1 shows the EVAL-AD76MUXCBZ evaluation board. When used in conjunction with the EVAL-CED1Z, the FPGA, U6, provides the necessary control signals for conversion and buffers the ADC serial output data into 16-bit wide transfers. The evaluation board is a flexible design that enables the user to choose among many different board configurations, analog signal conditioning, reference, and different interfaces for conversion results.

In stand alone operation, the FPGA can be used to buffer the 4-wire interface via P3, or directly to the 4 digital interface test points SDO, SCK, DIN and CNV. For stand alone mode, supply power to the evaluation board as detailed in the Power Supplies and Grounding section below.

For FPGA buffered serial interface, supplying power is all that is necessary. For direct serial connection to the ADC, place a jumper across P3-39 and P3-40 as P3-40 pulled low places the FPGA into high impedance.

## CONVERSION CONTROL

Conversion start (CNV) controls the sample rate of the ADC and is the only input needed for conversion; all SAR timing is internally generated on the ADC. CNV is generated by the gate array and the frequency is selected with the software.

While the ADC is converting, activity is indicated by the green LED, CR1. Operating the software in Burst mode as opposed to Continuous mode, will only light the LED when conversion is taking place.

For stand alone operation, connect a low jitter source to either P3-8 or CNV.

## ANALOG INPUTS

SMB connectors, J1 and J2, are provided for the ADC input channels IN0 and IN1 (IN0 only on AD7682). These inputs are also on the IDC connector P1-2 and P1-4. The remaining inputs are also on P1-6 through P1-16 (even pins only). J3 can be configured for providing a common point (COM) for all input signals or for any analog input IN0-IN7. For using J3 as an external common point, remove the solder pad (bottom of PCB) from “COMS to COM” and solder “EXT\_COM to COM” as shown below.



To configure J3 to drive any of the analog input channels, remove R35 from the left pads (bottom of PCB) and solder it to the rightmost pads.

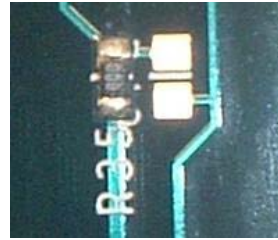

The analog input amplifier circuitry U13 – U20 (see schematic - Figure 13) allows flexible configuration changes such as positive or negative gain, input range scaling, filtering, addition of a DC component, use of different op-amp and supplies. The analog input amplifiers are set as unity gain buffers at the factory. The supplies are selectable with solder pads VDRV- and VDRV+ and are set for the +7V, -5V range.

Note that when using the unipolar configuration, COMS (P8) is set to (P8, 2-3) and for bipolar input configuration set to (P8, 1-2) with pin 1 being the leftmost pin.

## SERIAL INTERFACE

The 3-wire serial interface DIN, SCK, and SDO along with CNV are present on the digital interface test points and FPGA buffered versions are on the 40-pin IDC connector, P3-2, -4, -6, -8. When connected to the EVAL-CED1Z and stand alone (without P3-39 to P3-40 jumper), signals are present at both locations. With P3-39 to P3-40 connected, these signals are only present at the test points SDO, SCK DIN and CNV.

## REFERENCE

All of the ADCs for this evaluation board can use a precision trimmed on-chip band gap reference, an on-board precision ADR435 band gap reference, or an external reference connected to the EXTREF test point (TP17). The on-chip reference is enabled or disabled with the software. The on-chip reference can be set for 2.5V or 4.096V outputs and also includes an internal buffer, useful for external reference applications. When using the on-chip reference, remove the jumper on TP7 since this will overdrive the on-chip reference with the external one.

The default configuration is for on-board ADR435 reference with a buffered output (P5 2-3), (P6 1-2) and (P7 1-2).

For using an external reference connect to the EXTREF test point (TP17), select a buffer or not with P6 and select if driving the ADC REF directly or using the ADC's internal reference buffer. When using the internal reference buffer with gain=1, the maximum output is limited to 4.096V (headroom from 5V supply).

The default configuration sets the amplifiers output to be at  $V_{REF}/2$  (mid-scale) from the voltage divider at U1B ( $V_{BIAS}$ ).

## POWER SUPPLIES AND GROUNDING

To attain high resolution performance, the board was designed to ensure that all digital ground return paths do not cross the analog ground return paths by connecting the planes together directly under the converter. Power is supplied to the board through P3 when using with the EVAL-CED1Z. For stand alone

operation, the evaluation board requires three different supplies and system ground. Connect a supply (7V to 12V) to the analog supplies test points +12V and +5VA. Connect -5V to the -5VA test point. Connect a supply (+3.3V to +5.5V max) to the FPGA power test point, VDIG.

Connect the power supply GNDs to the GND test point at the power supplies section of test points making certain the both analog and digital GNDs are at the same potential.

### SCHEMATICS/PCB LAYOUT

The EVAL-AD76MUXCBZ is a 6-layer board carefully laid out and tested to demonstrate the specific high accuracy performance of the ADC. Figure 13 through Figure 19 shows the schematics of the evaluation board. The silkscreens for the PCB are given in Figure 20 and Figure 22.

### HARDWARE SETUP

#### System Requirements

- EVAL-AD7682CBZ, EVAL-AD7689CBZ, EVAL-AD7699CBZ, EVAL-AD7949CBZ
- Evaluation Converter Evaluation and Development board, EVAL-CED1Z
- Enclosed World compatible 7V DC supply
- Enclosed USB to mini USB cable
- DC source (low noise for checking different input ranges)
- AC source (low distortion)
- Band pass filter suitable for 16 or 18 bit testing (value based on signal frequency)
- PC operating Windows XP.

Proceed to the Software Installation section to install the software. **Note: The EVAL-CED1Z board must not be connected to the PC's USB port until the Software is installed.** The 7V DC supply can be connected however to check the board has power (green LED lit).

### SOFTWARE INSTALLATION

It is recommended to close all Windows' applications prior to installing the software.

#### System Requirements

- PC operating Windows XP.
- USB 2.0 (for CED board)
- Administrator privileges

**CD-ROM** –Navigate to Software\CED Version x.x, double click on *setup.exe* and follow the instructions on the screen. If another version of Analog Devices PulSAR Evaluation Software is present, it may be necessary to remove this. To remove, click on the Windows "Start" button, select "Control Panel" and "Add or Remove Programs". When the list populates, navigate to Analog Devices High Resolution sampling ADC's Evaluation Software or PulSAR Evaluation Software and select Remove.

#### Website Download

The software versions are also available from the Analog Devices PulSAR Analog to Digital Converter Evaluation Kit

page. After downloading the software, it is recommended to use the WinZip "Extract" function to extract all of the necessary components as opposed to just clicking on *setup.exe* in the zipped file. After extracting, click on *seteup.exe* in the folder created during the extraction and follow the instructions on the screen. If another version exists, it may be necessary to remove as detailed in the above CD-ROM section.

#### USB Drivers

The software will also install the necessary USB drivers. After installing the software, power up the CED board and connect to the PC USB 2.0 port. The Windows "Found New Hardware" Wizard will display. Click on Next to install the drivers automatically.



When installed properly, Windows displays the following.

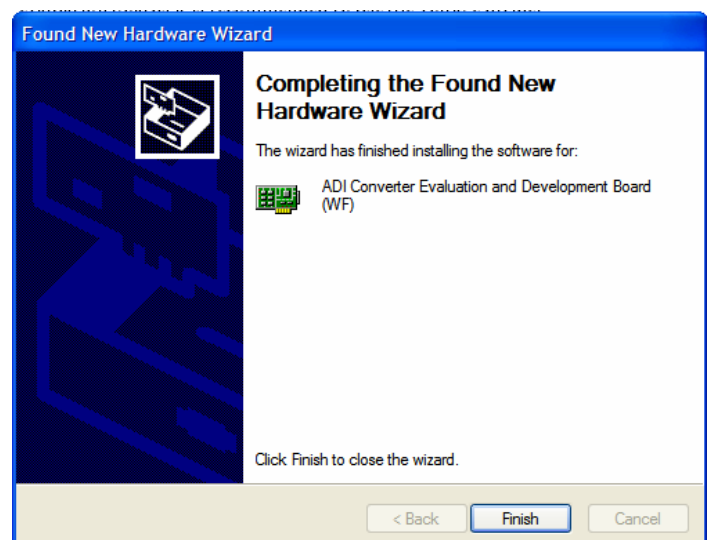

On some PCs, the Found New hardware Wizard may show up again and if so follow the same procedure to install it properly.

The "Device Manager" can be used to verify that the driver was installed successfully.



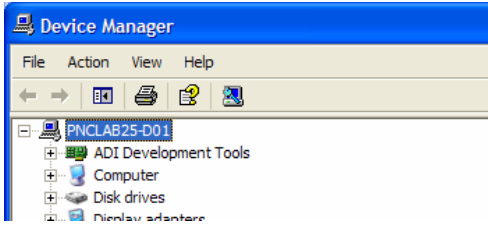

**Troubleshooting the Install**

If the driver was not installed successfully the device manager will display a question mark for “Other devices” as Windows does not recognize the CED1Z board.

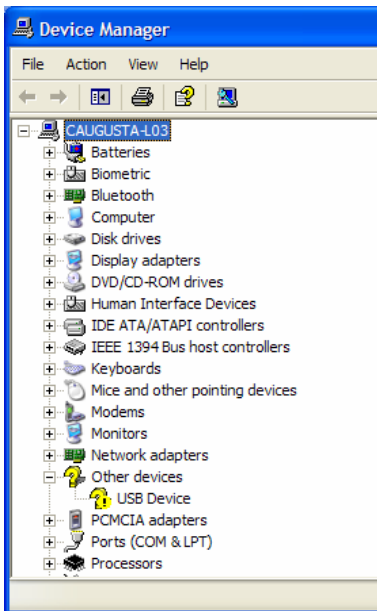

The “USB Device” can be opened to view it’s uninstalled properties.

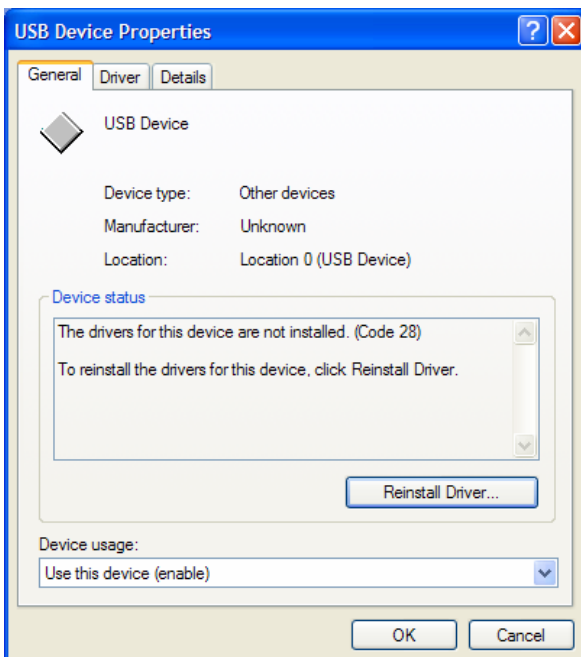

This is usually the case if the software and drivers were installed by a user without administrator privileges. If so, log on as an administrator with full privileges and reinstall the software.

**RUNNING THE EVALUATION SOFTWARE**

The evaluation board includes software for analyzing the AD7682, AD7689, AD7699 and AD7949. The EVAL-CED1Z is required when using the software. The software is used to perform the following tests:

- Histogram for determining code transition noise (DC)
- Fast Fourier transforms (FFT) for signal to noise ratio (SNR), SNR and distortion (SINAD), total harmonic distortion (THD) and spurious free dynamic range (SFDR)
- Decimation (digital filtering)

The software is located at C:\Program Files\Analog Devices\PulSAR ADC Evaluation Software\Eval PulSAR CED.exe.

A shortcut is also added to the Windows “Start” menu under “Analog Devices PulSAR ADC Evaluation Software”, “Eval PulSAR CED”. To run the software, select the program from either location.

**SETUP SCREEN**

Figure 2 is the setup screen where ADC device selection, test type, input voltage range, sample rate and number of samples are selected.

**CONFIGURING THE ADC**

These ADCs need to be configured through a dedicated SPI compatible serial port. The included SW configures the part to a default configuration. Each of the different configurable parameters are shown in the ADC Configuration section, detailed in Figure 3 to Figure 7.

**DC TESTING - HISTOGRAM**

Figure 9 is the histogram screen, which tests the code distribution for DC input and computes the mean and standard deviation or transition noise. To perform a histogram test, select “Histogram” from the test selection window and click on the “Start” radio button. Note: a histogram test can be performed without an external source since the evaluation board has a buffered  $V_{REF}/2$  source at the ADC input. To test other DC values, apply a source to the J1/J2/P1-x inputs. It is advised to filter the signal to make the DC source noise compatible with that of the ADC.

**AC TESTING**

Figure 11 is the FFT screen, which performs an FFT on the captured data and computes the SNR, SINAD, THD and SFDR. Figure 12 is the time domain representation of the output. To perform an AC test, apply a sinusoidal signal to the evaluation board at the SMB inputs J1 for CH0 and J2 for CH1. Low distortion, better than 100dB, is required to allow true evaluation of the part. One possibility is to filter the input signal from the AC source. There is no suggested bandpass filter but

consideration should be taken in the choice. Furthermore, if using a low frequency bandpass filter when the full-scale input range is more than a few  $V_{pp}$ , it is recommended to use the on

board amplifiers to amplify the signal, thus preventing the filter from distorting the input signal.

**Table 1. Jumper Description**

Jumper	Name	Default Position	Function
P5	-	REFS	Reference source selection. REFS to middle pin: uses ADR435 (A1) 5V, 4.096V or 2.5V output. VDD to middle pin: VDD supply is used as a reference. Open: optional source can be connected to TP17/ $V_{REF}$ .
P6	-	BUF	Reference buffer selection. BUF to middle pin: buffer selection from P5 with the AD8032-A (U2). NOBUFF to middle pin: use P5 direct (no buffer).
P7	REF/REFIN	REF	ADC REF/REFIN input selection. REF to middle pin: external source drives ADC REF pin. REFIN to middle pin: external source drives REFIN, reference buffer input pin Open: When using the on-chip reference.
P8	COMS	VCM	Common channel select. VCM to middle pin: for bipolar mode, selects $V_{REF}/2$ . GND to middle pin: for unipolar operation, selects GND.
JP9	5V	5V	External reference selection of 5V.
JP10	4.096V	Open	External reference selection of 4.096V.
JP11	2.5V	Open	External reference selection of 2.5V.
SB0-7	BUF Select	BUF	Use on-board analog amplifiers (U13 – U20) BUF: use amplifier NO BUF: bypass amplifier
-	VDRV-	-5V	Amplifiers (U13-U20) (-) supply.
-	VDRV+	7V	Amplifiers (U13-U20) (+) supply.
-	VCCREF	12V	ADR435(A1) (+) supply.
-	VDDR	5V	ADC (U7) VDD supply. Must always be the same as VDD.
-	VDD	5V	ADC (U7) VDD supply.
-	VIO	3.3V	ADC (U7) VIO interface supply.

Table 2. Test Points

Test Point	Available Signal	Type	Description
TP8	GND	P	FPGA power supply GND.
TP9	-5VA <sup>1</sup>	P	Amplifier negative supply.
TP10	+5VA <sup>1</sup>	P	5V analog supply.
TP11	+12VA <sup>1</sup>	P	12V analog supply.
TP12	GND	P	Analog supply GND.
TP13	VDD	P	ADC (U7) VDD supply.
TP14	VDDR	P	ADC (U7) VDD supply. Must always be = AVDD above.
TP15	VIO	P	ADC (U7) VIO interface supply.
TP17	VREF	AI	External reference input.
TP18	REF	AI/O	ADC on-chip reference output or external reference input.
TP19	REFIN	AI/O	ADC on-chip band-gap output or external reference input when using on-chip reference buffer.
TP20	IN0	AI	Analog input for ADC IN0 on both 4 and 8-channel ADCs.
TP21	IN1	AI	Analog input for channel 1 on 8-channel ADCs only.
TP22	COM	AI	Sets the level on ADC COM; GND or $V_{REF}/2$ .
TP24	SDO	DO	Serial data output from ADC.
TP25	SCK	DI	Serial clock data input to ADC.
TP26	DIN	DI	Serial data input for part configuration.
TP27	CNV	DI	Conversion input to ADC
TP71	GND	P	Analog supply GND.
TP76	VDIG <sup>1</sup>	P	FPGA power supply.

Table 3. Bill of Materials for the Connectors

Ref Des	Connector Type	Manf.	Part No.
J1, J2, J3	RT Angle SMB Male	Pasternack	PE4177
P1	0.100 X 0.100 straight IDC header 2X10	3M	2540-6002UB
P2	0.100 X 0.100 straight IDC header 2X20	3M	2540-6002UB
P4	32X3 RT PC MOUNT CONNECTOR	ERNI	533402

<sup>1</sup> Supplied by EVAL-CED1Z when connected.

SOFTWARE OPERATION

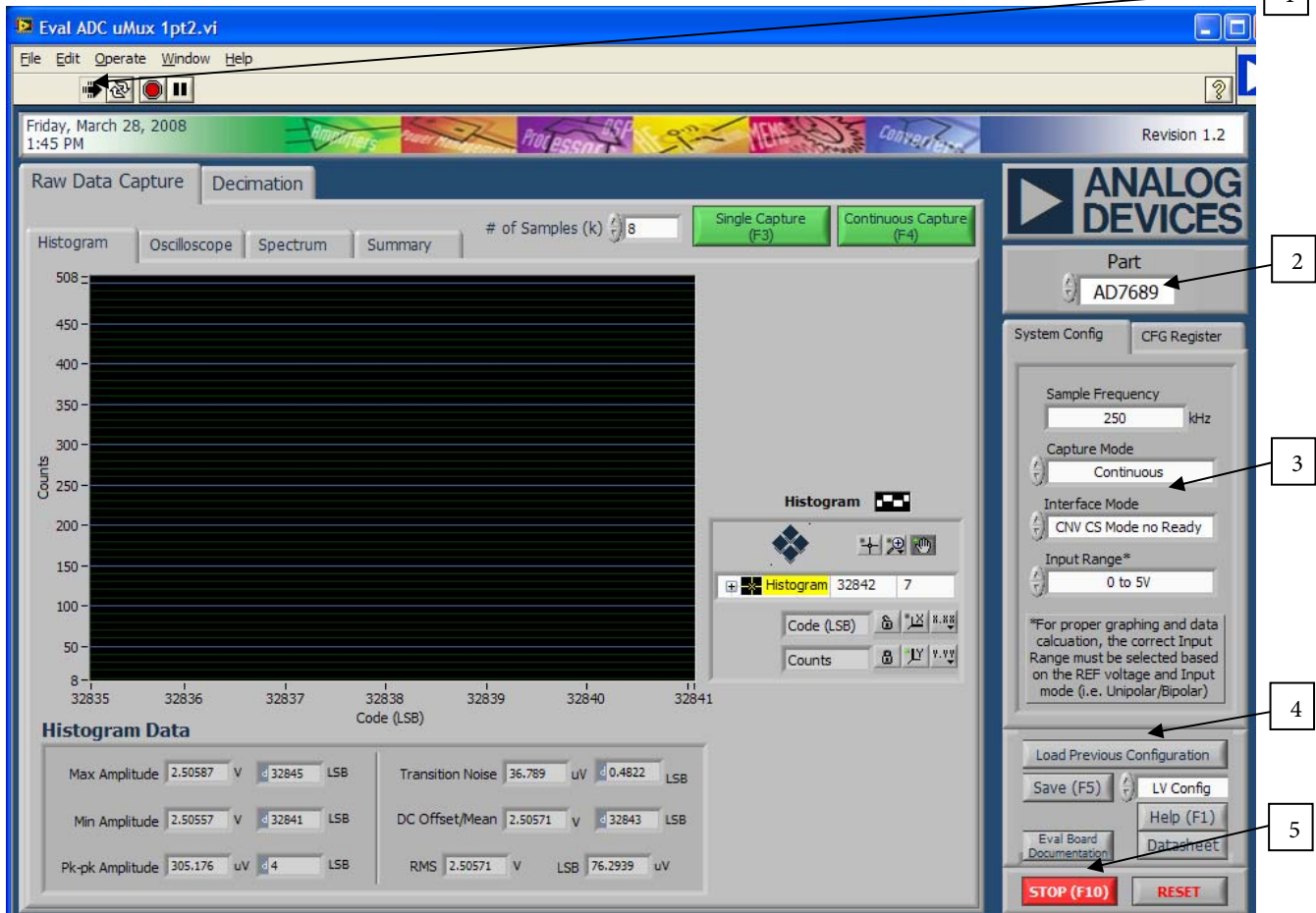



Figure 2. Setup Screen

The following details the operation of the software.

1. The arrow  is used to start the software. When running  is displayed.

2. The part to be evaluated is selected here.

3. The controls are used to set:

**Sample Frequency** – units can be used such as 500k (case sensitive) for 500,000 Hz.

**Capture Mode** – This selects between continuous (Cont.) or burst conversion modes. In continuous mode, the ADC is continuously converting. In Burst mode, the ADC is not converting (sample clock held in inactive state) and the conversions begin once the “Single Capture” or “Continuous Capture” buttons have been selected.

**Interface mode** – This selects the digital interface to the on-board FPGA.

**Input Range** – this is used to adjust the LSB size in the data field of the plot window.

4. These controls are used for saving, printing, help, etc. and are also accessed in the File menu.

Save (F5): type – LabView config, allows the current configuration to be saved to a *filename.dat* file. Useful when changing many of the default controls. To load the saved configuration, use the Load Previous Configuration. Note the location of the .dat file. It is recommended to place into the Support Files directory in the directory where the software was installed.

Type – Html, saves the current screen shot to an Html file.

Type – Spreadsheet, saves the current data displayed in the chart in a tab delimited spreadsheet. Raw ADC Data is time domain in V or Code, FFT or Decimated is in dB.

5. Stop (F10) is used to stops the software. The  can also be used to stop the software. RESET is used to reset the EVAL-CED1Z.



### ADC CONFIGURATION

The ADC needs to be configured for input configuration, reference, channel to be converted, temperature sensor, and on-chip low pass (LP) filter (optional) for full bandwidth (BW) or 1/4 BW. These next figures show the pull down configurations available. Note the default value when the program is started is indicated by the ✓; or CFG writing enabled, unipolar INn to GND, CH0, full BW, and external reference. Note that after updating the CFG, the first conversion (when using burst mode) will be of the last configuration since the ADC has a 1-depp delay for the CFG.

Figure 3 shows the default values.

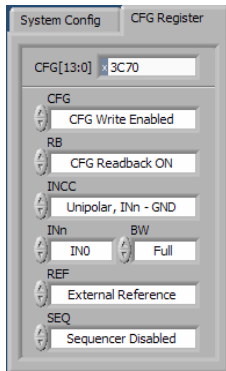

Figure 3. Default CFG

Figure 4 details CFG Write Enabled/Disabled. When enabled, the MSB of the CFG is set high. When disabled the MSB is set low thus the remaining 13 bits are ignored.

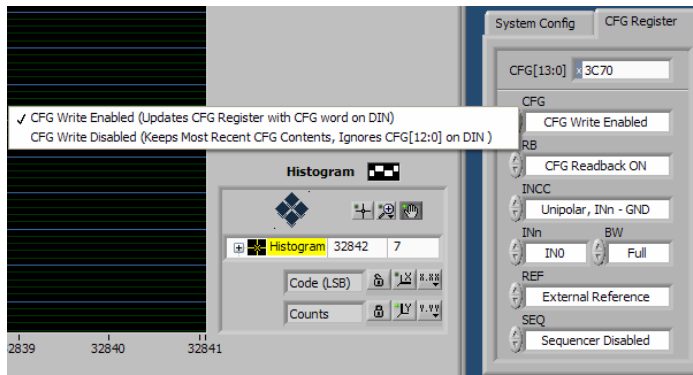

Figure 4. CGF Enable/Disable Selection

Figure 5 details the inputs (IN0-IN7) configuration and channel selection. Refer to the datasheet for more information about the input configurations. Note that in the bipolar mode, the input, IN+ and COM (or IN-) must be centered around VREF/2.

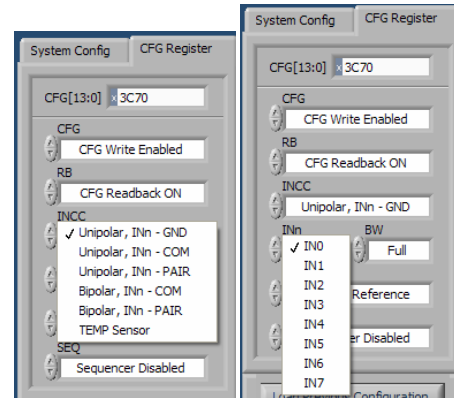

Figure 5. Input Configuration/Channel Selection

Figure 6 details the bandwidth selection of the 1-pole low pass filter, which can reduce the noise from the amplifier circuit, if desired. Note that the throughput of the converter must also reduce to 1/4 of the maximum when setting to 1/4 BW.

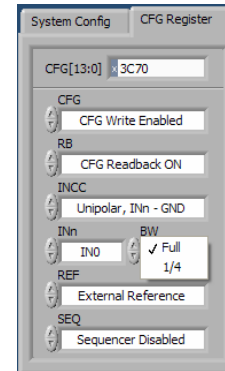

Figure 6. BW Select

Figure 7 details the reference selection. Note that the TEMP sensor can be used with an external reference. The Temp sensor can be used to monitor the temperature of the ADC and the output is straight binary and referenced to the ADC GND. The displayed results should be in Volts format as opposed to Hex.

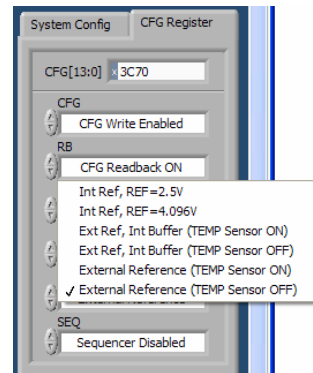

Figure 7. Reference Selection

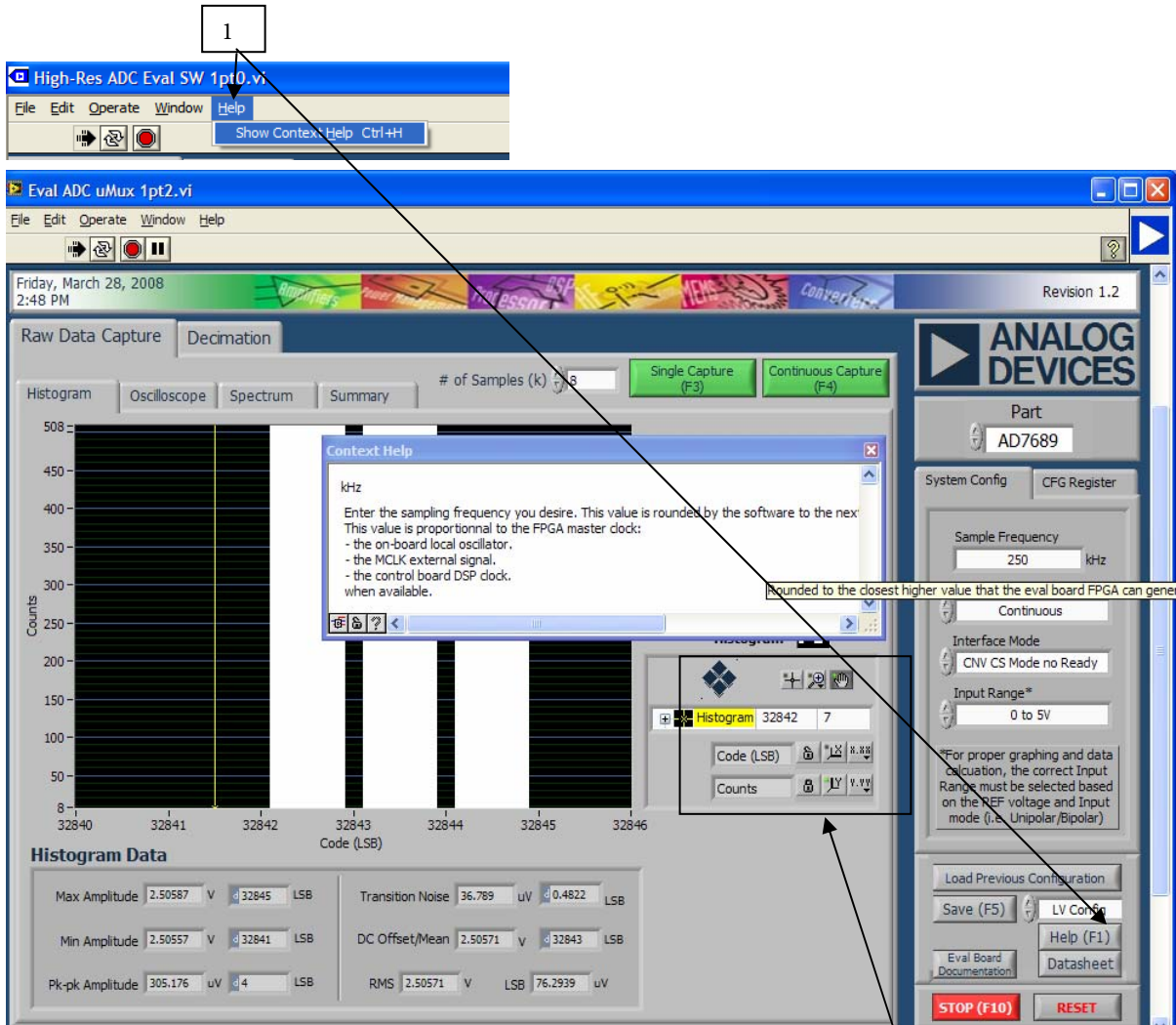

Figure 8. Context Help, User Controls

1. To use the on-screen help. Select Help, Show Context Help or click the Help (F1). An example of the Context Help is shown above for the Sample Frequency. Placing the cursor on most screen items displays useful help for the particular control or displayed unit.

2. These controls are used for axes and zooming panning.

- Locks the graph axis to automatically fit the data.
- Uses last axis set by user. , rescale the axes to the automatic values.

, are used to set axes properties such as format, precision, color, etc.

Displays the cursor.

Is used For zooming in and out.

Is used for panning.

Is used to set various graph properties such as graph type, colors, lines, etc.

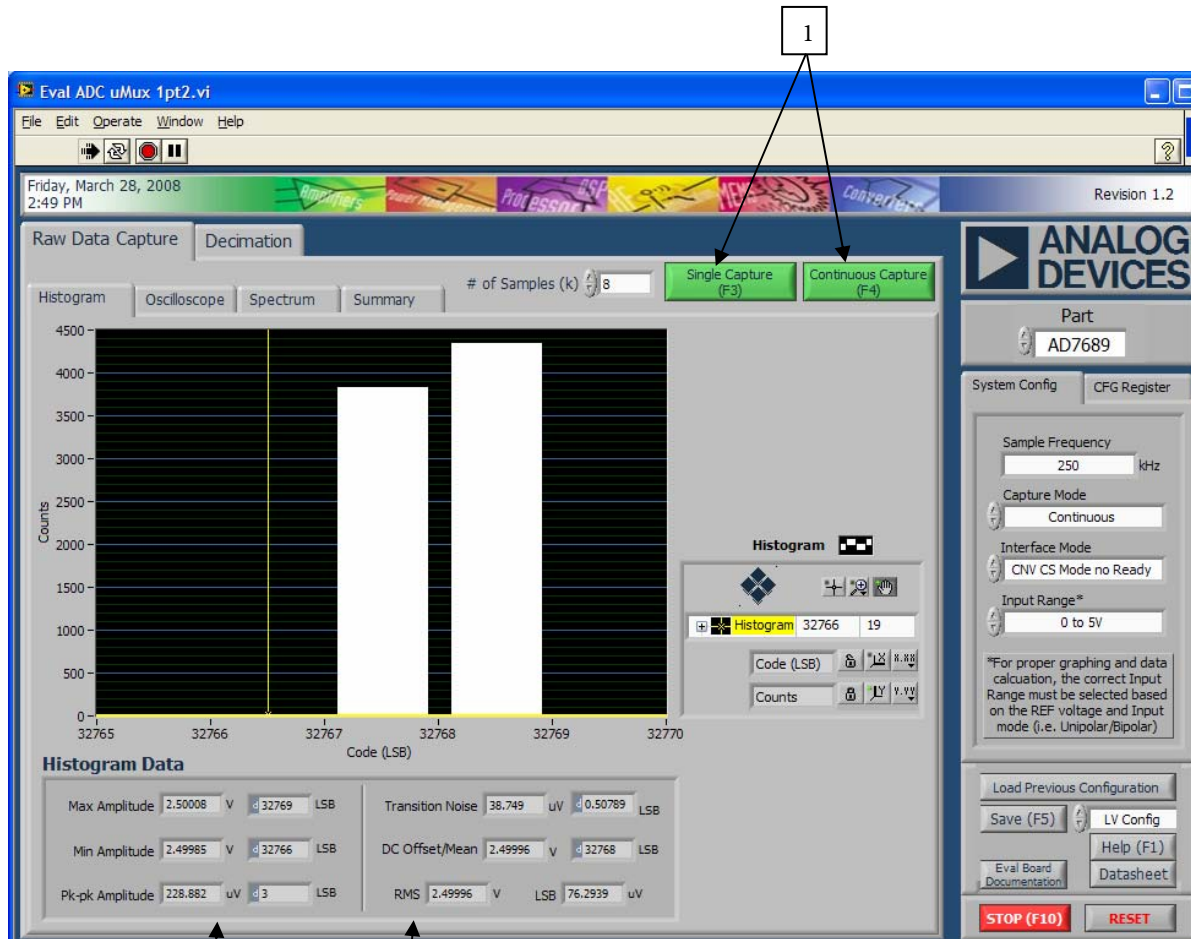
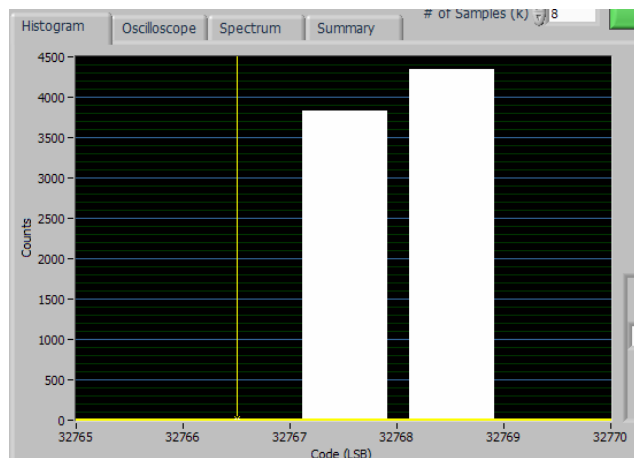
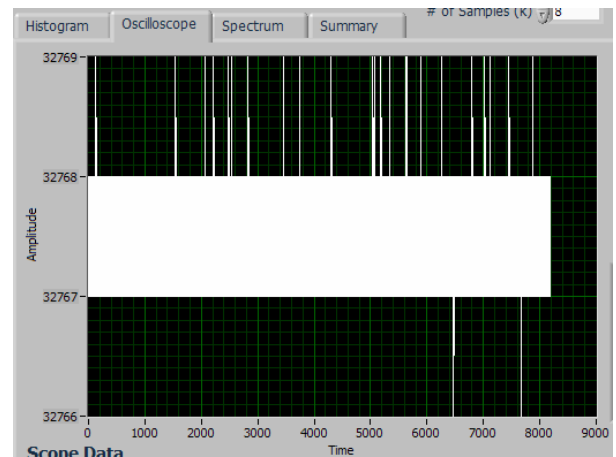

Figure 9. Histogram Screen

1. These radio buttons are used to perform a Single Capture or Continuous Capture of data set in the # of Samples field. The results are displayed in the chart. Note that the results can be displayed as:



A Histogram



Or an Oscilloscope (time domain)

2., 3. These display the statistics for the X and Y-axes, respectively.

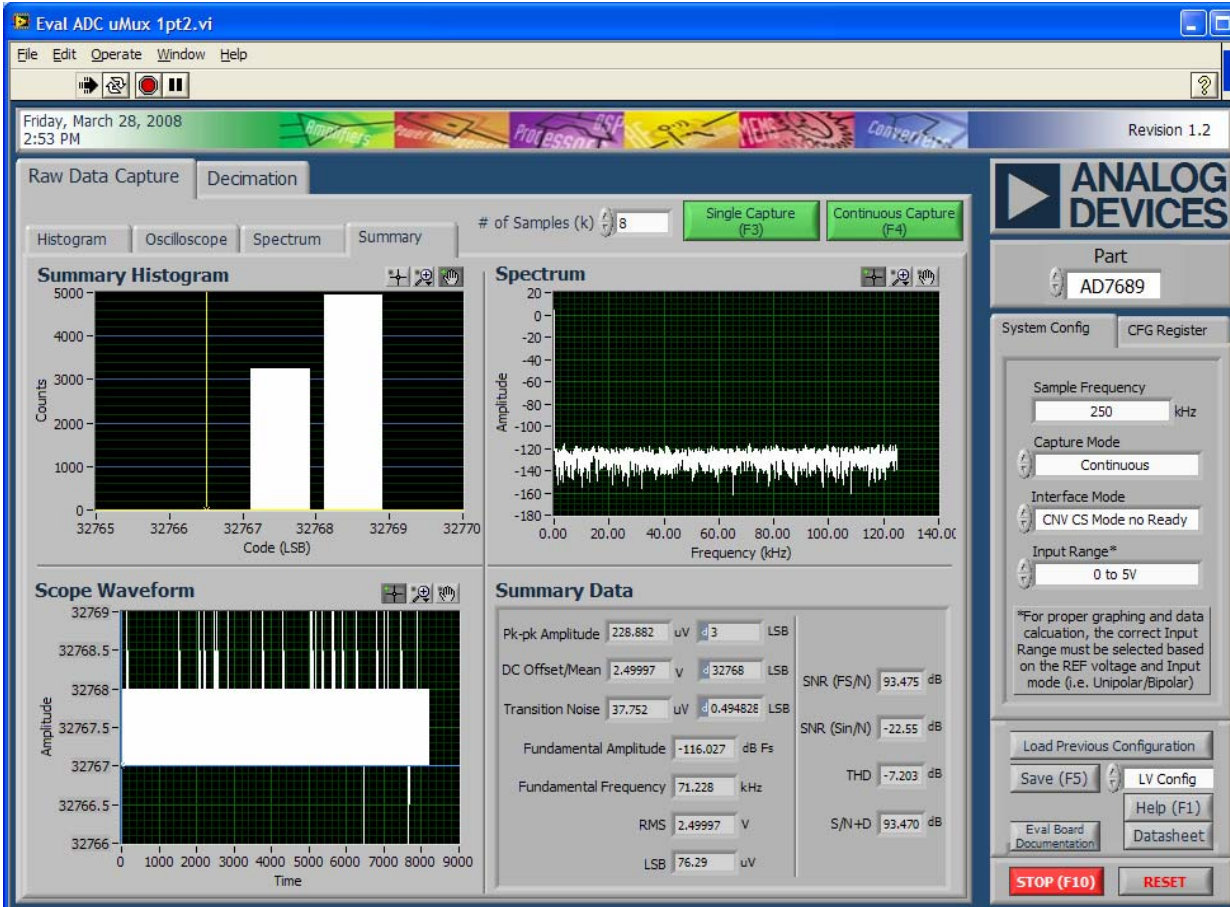
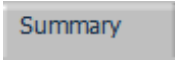

Figure 10. Summary

The charts can be displayed together when the  tab is selected.



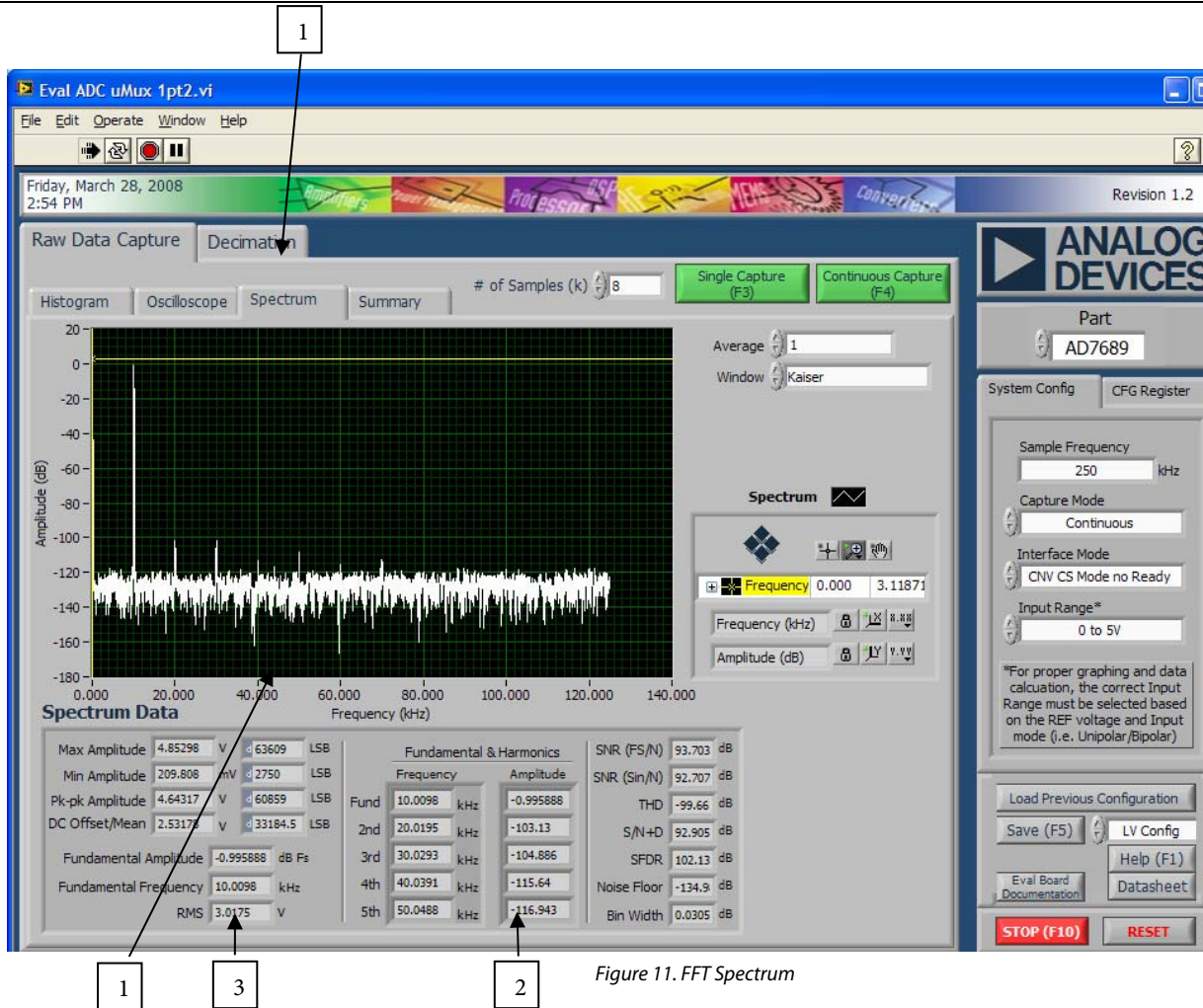

Figure 11. FFT Spectrum

1. Displays the FFT when the Spectrum chart is selected
- 2., 3. Display the data for the X and Y-axes, respectively.



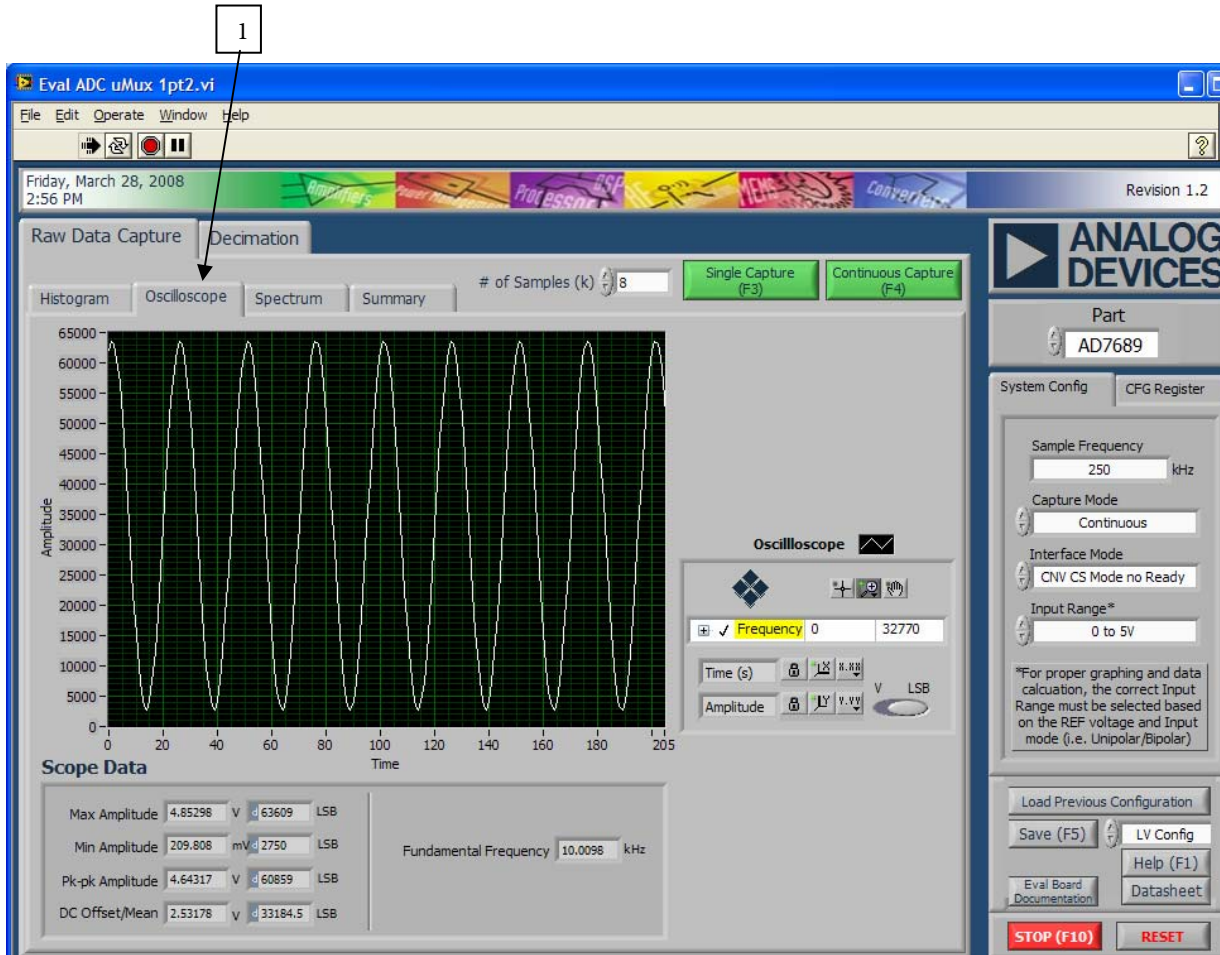

Figure 12. Oscilloscope

1. Time domain data can be viewed with the oscilloscope also.

EVALUATION BOARD SCHEMATICS AND ARTWORK

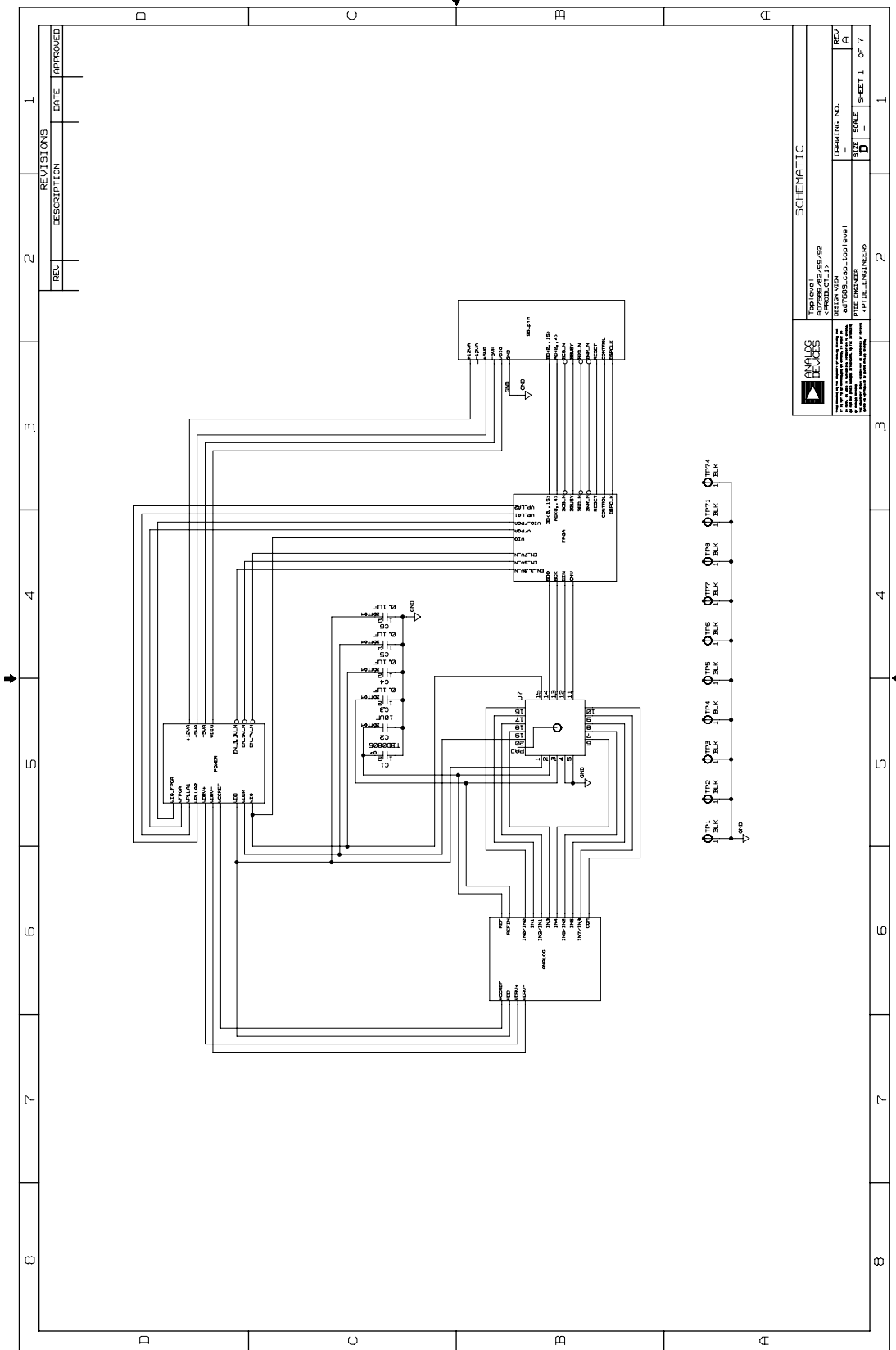

Figure 13. Schematic, ADC + Block Diagram

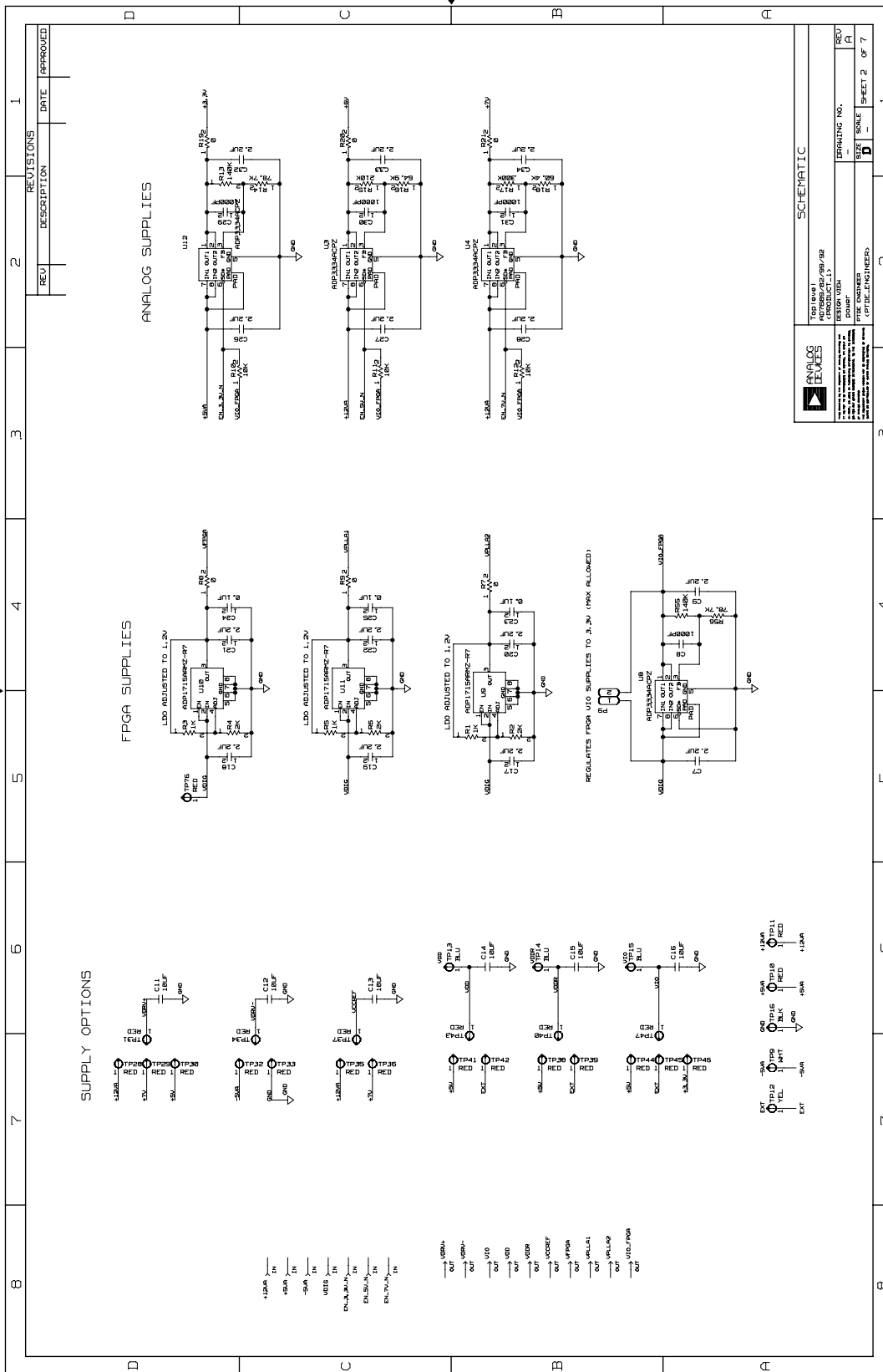
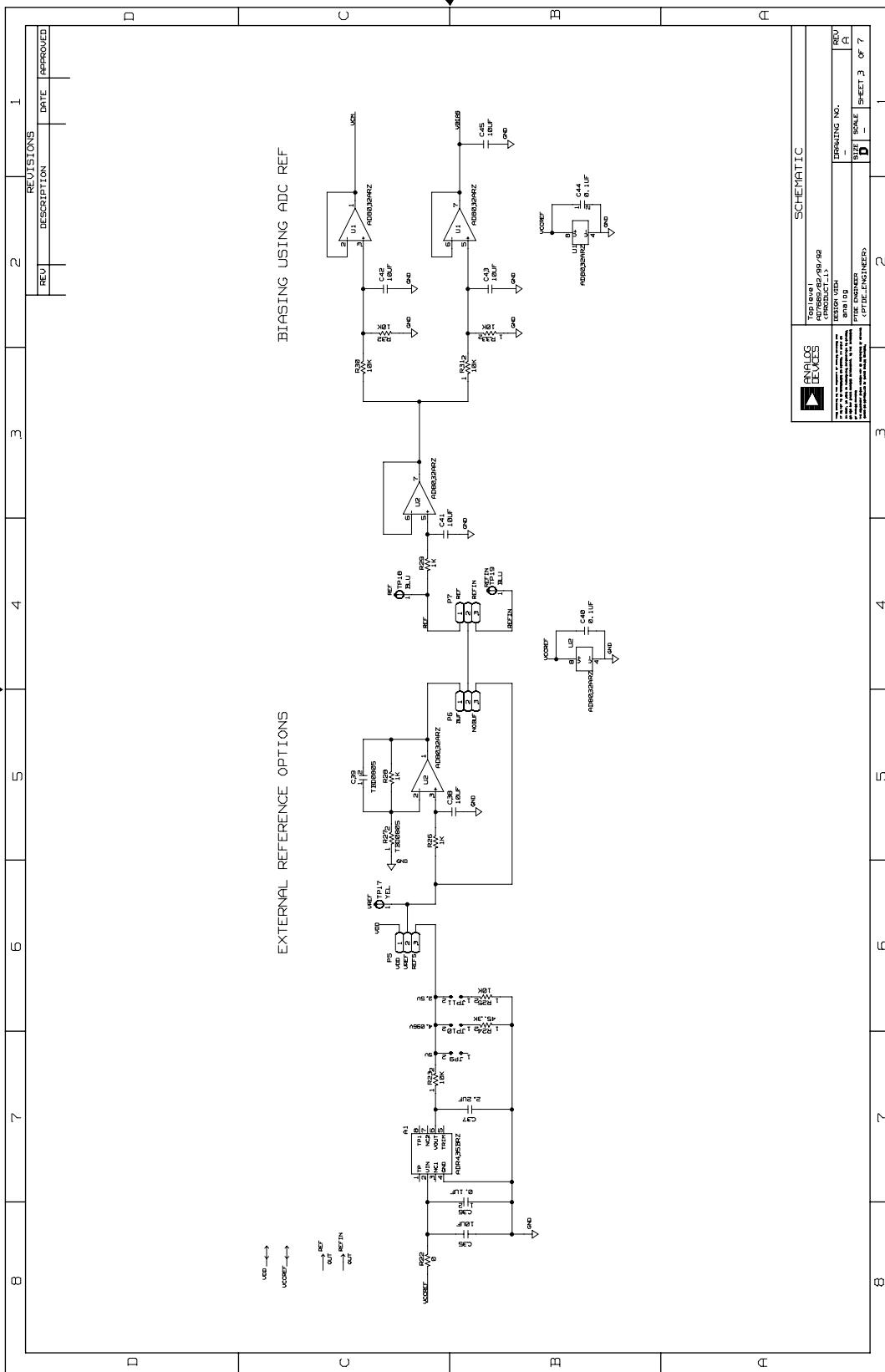

Figure 14. Schematic, Supplies



REV	DESCRIPTION	DATE	APPROVED

		SCHEMATIC	
Top Level 1 EVAL-AD76MUXEDZ EVAL-AD76MUXEDZ			
PART NO. EVAL-AD76MUXEDZ		SHEET NO. SHEET 3 of 7	
© 2008 Analog Devices, Inc. All rights reserved.			

Figure 15. Schematic, Reference, Buffer,  $V_{CM}$ ,  $V_{BIAS}$

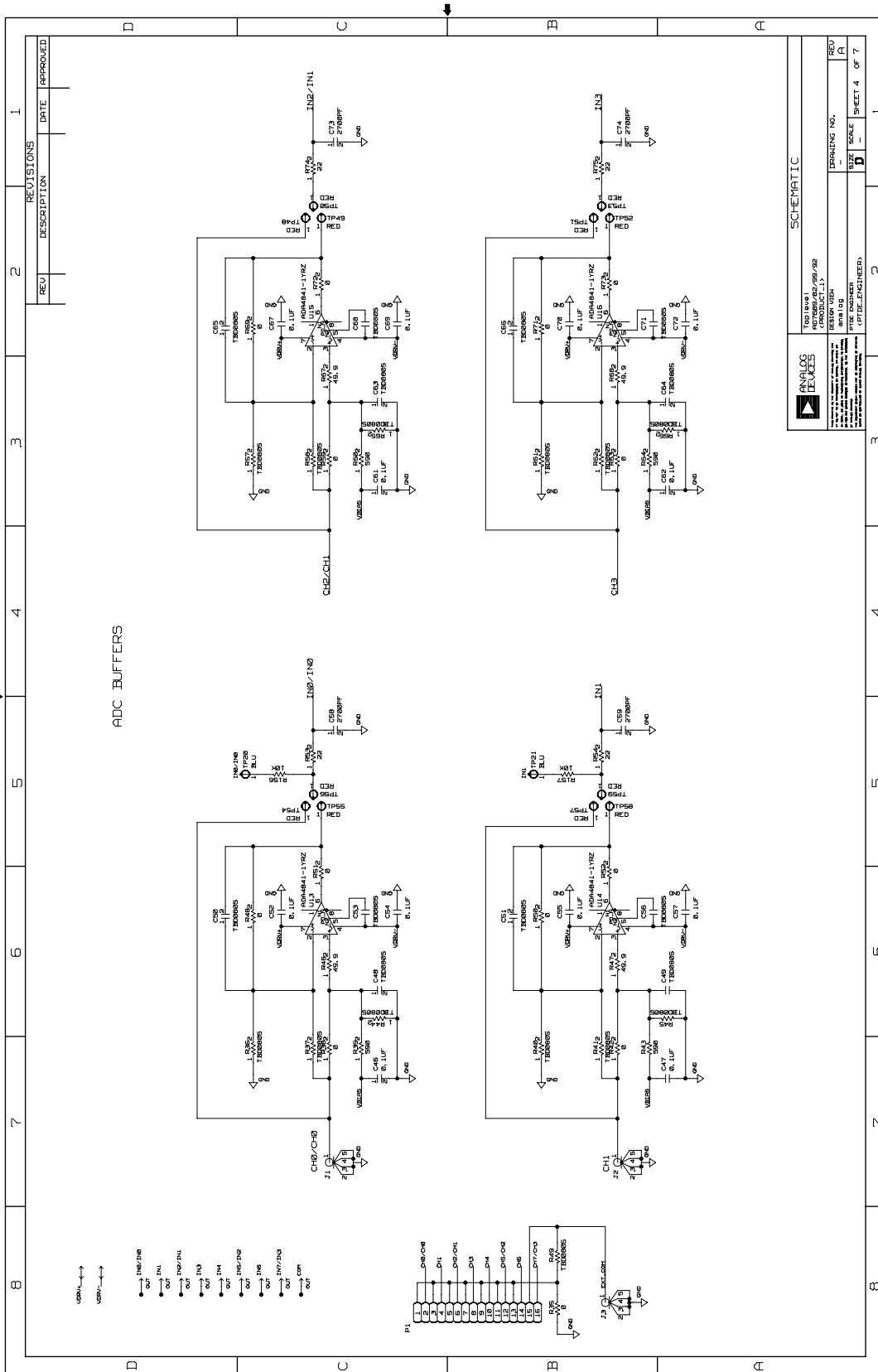
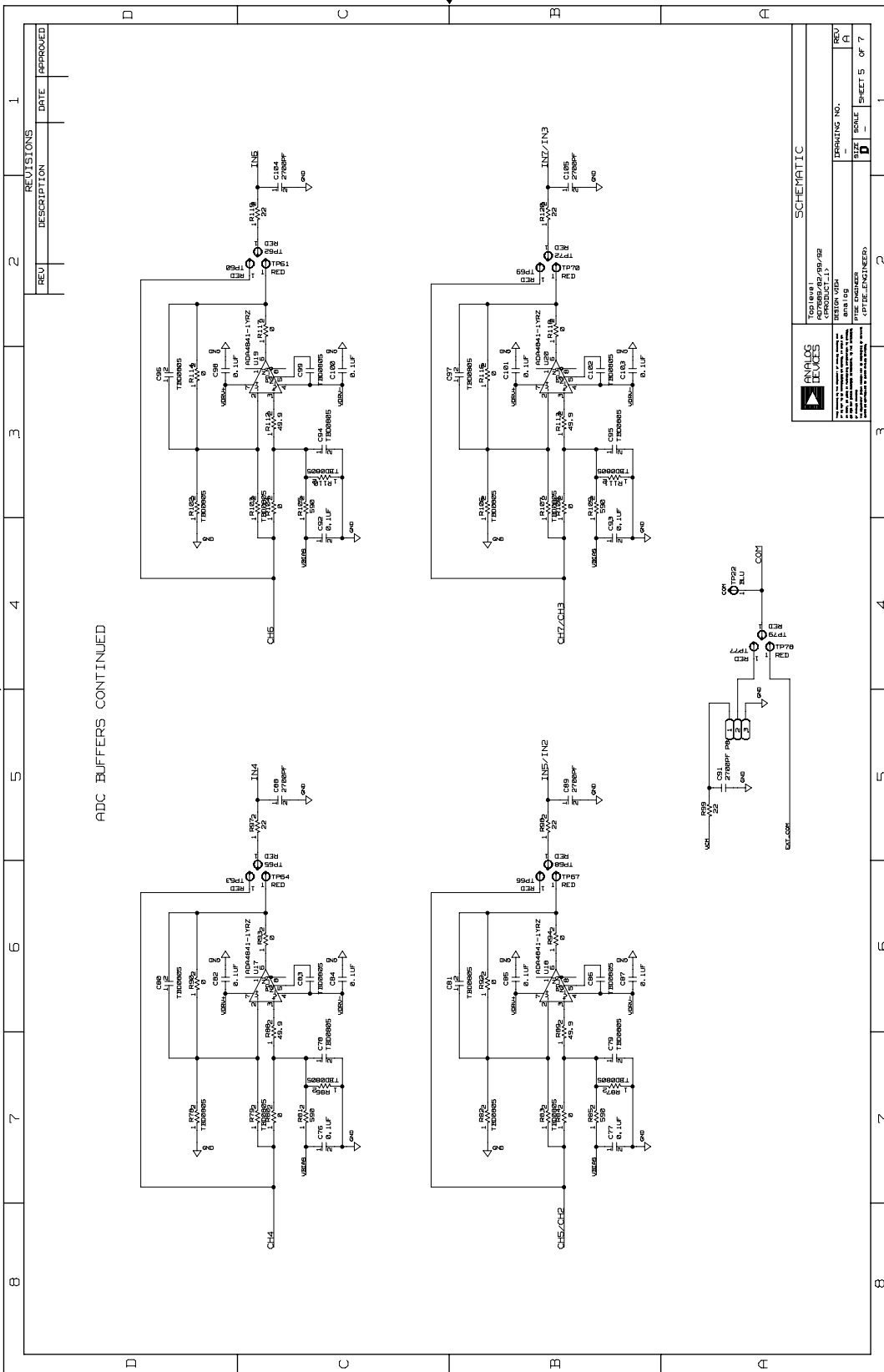

Figure 16. Schematic, AnalogCH0-CH3





REV	DESCRIPTION	DATE	APPROVED

		SCHEMATIC	
Top Level 1 AD76M04-1V02 REVISION NO. 1 REV. A DATE 10/10/07 BY 10101 CHECKED BY 10101 APPROVED BY 10101 (PRINT/ENGINEER)			
REV	DESCRIPTION	DATE	APPROVED

Figure 17. Schematic, AnalogCH4-CH7

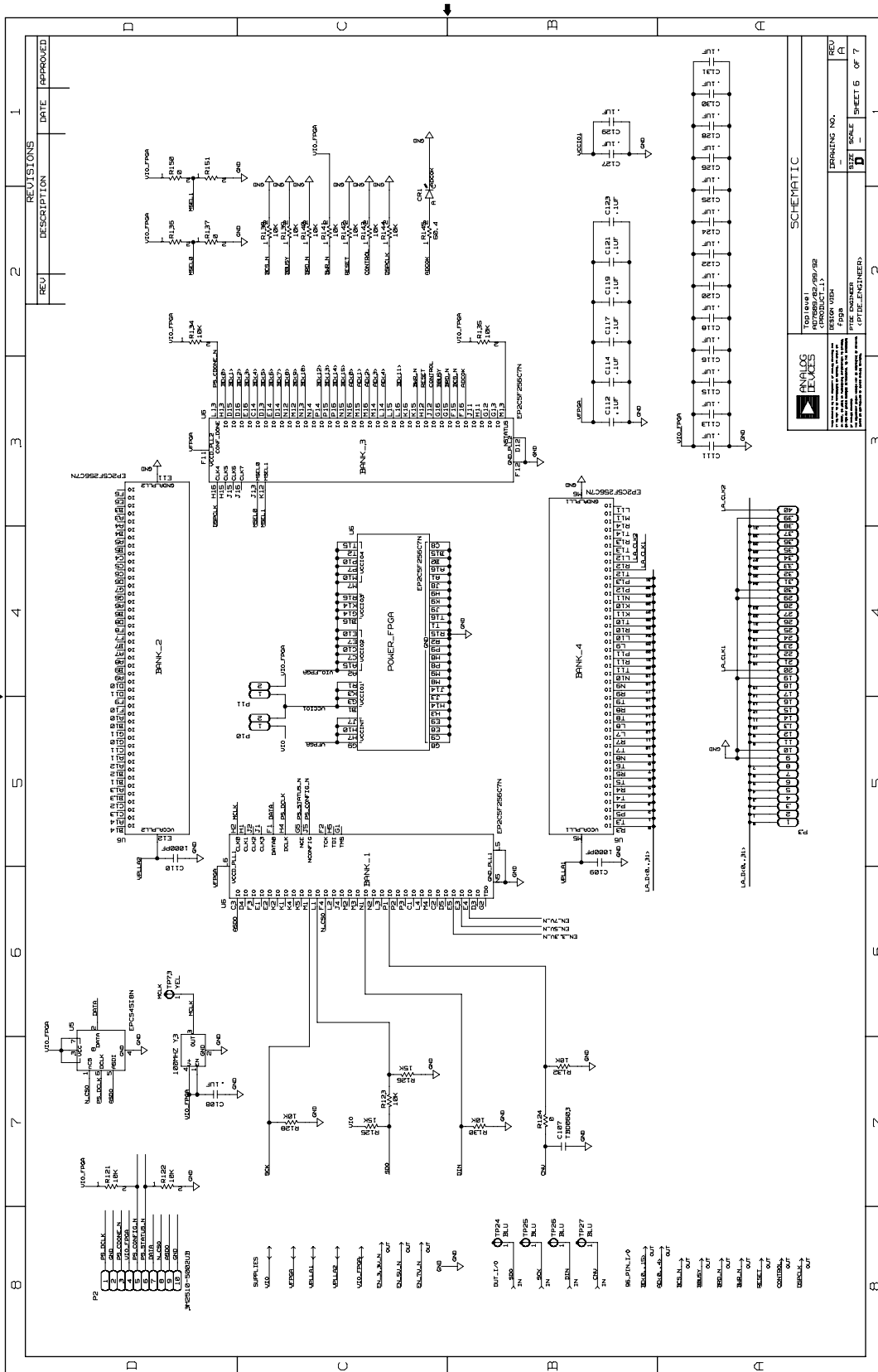

Figure 18. Schematic, FPGA

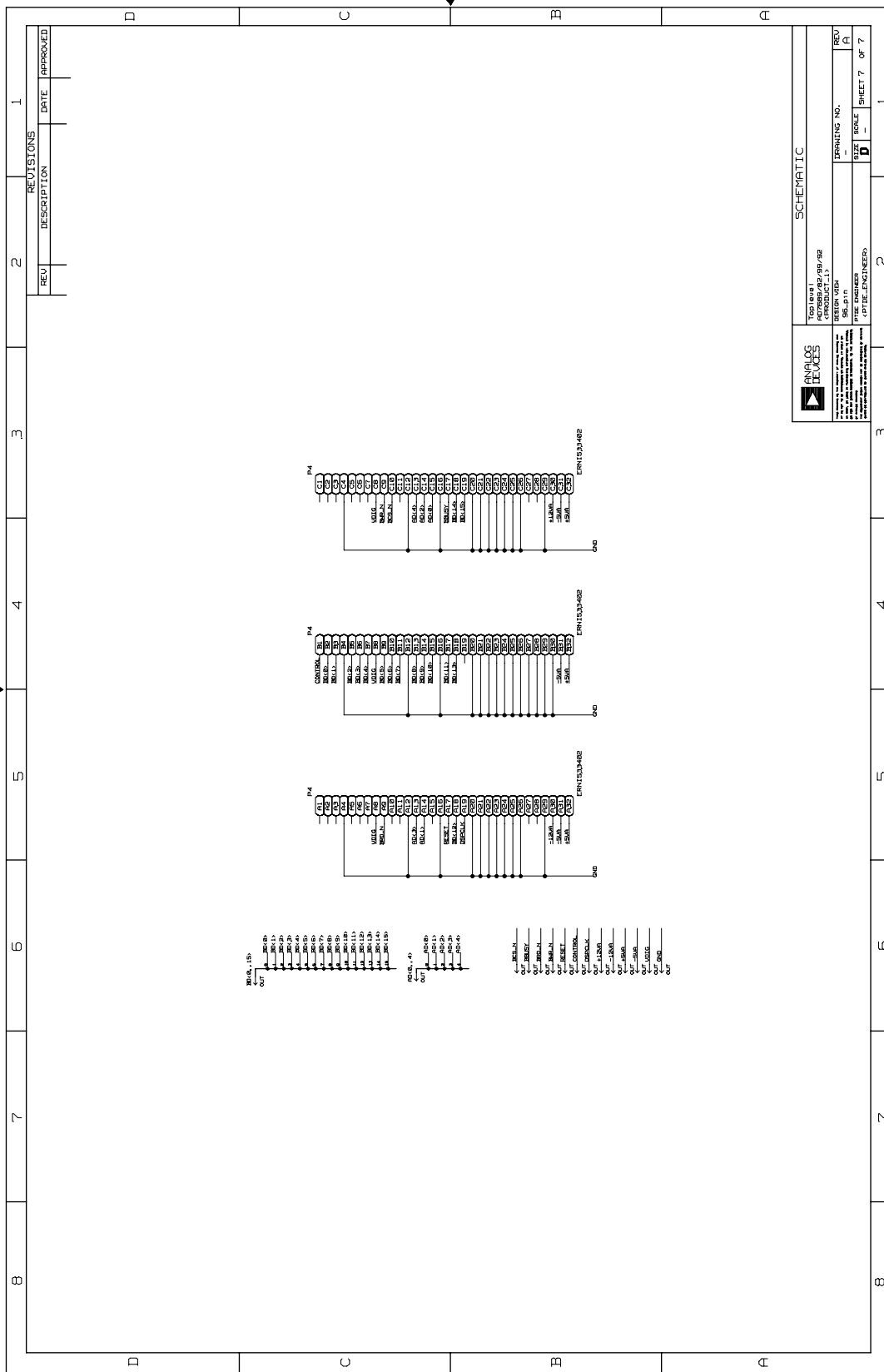

Figure 19. Schematic, 96-Pin Interface

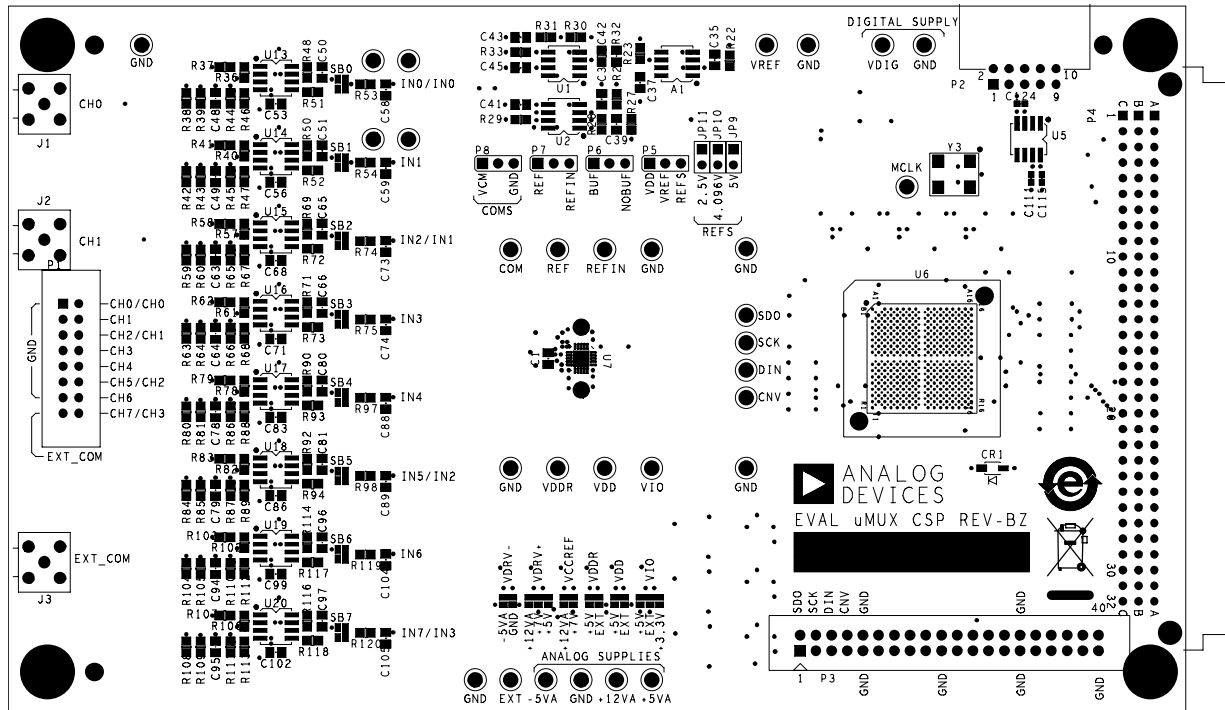

Figure 20. Top Side Silk-Screen  
(Viewed from top side)

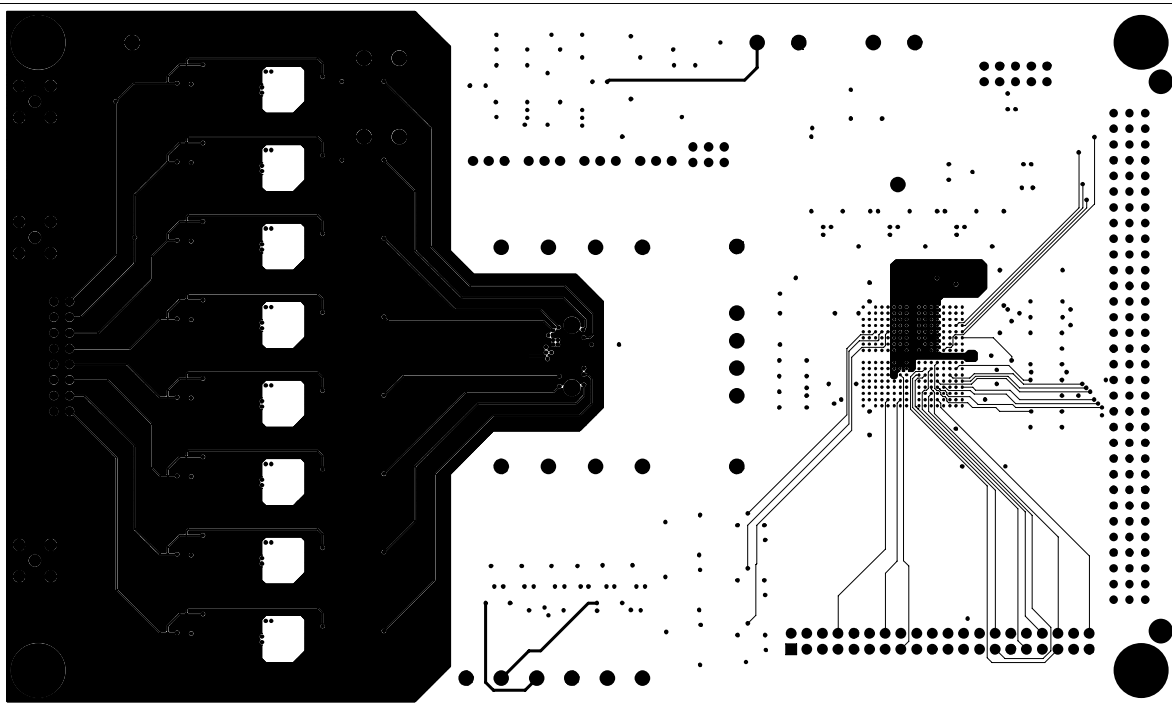

Figure 21. Inner Layer 1  
(Viewed from top side)

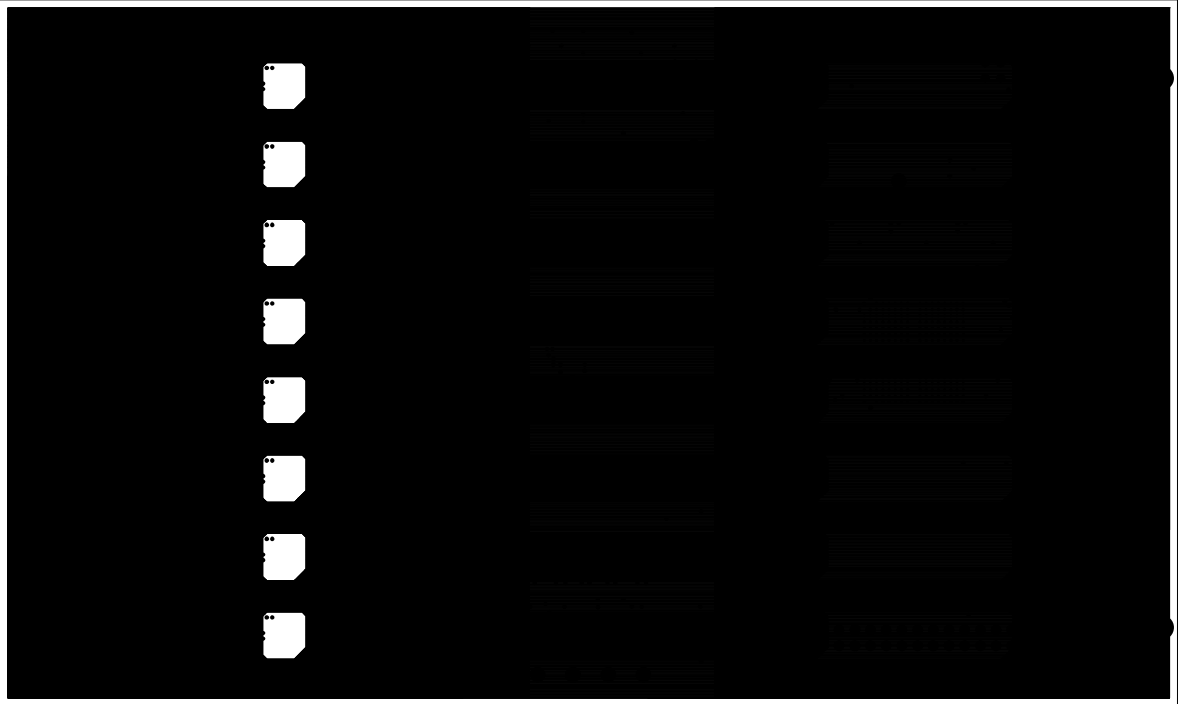

Figure 22. Ground Plane  
(Viewed from top side)

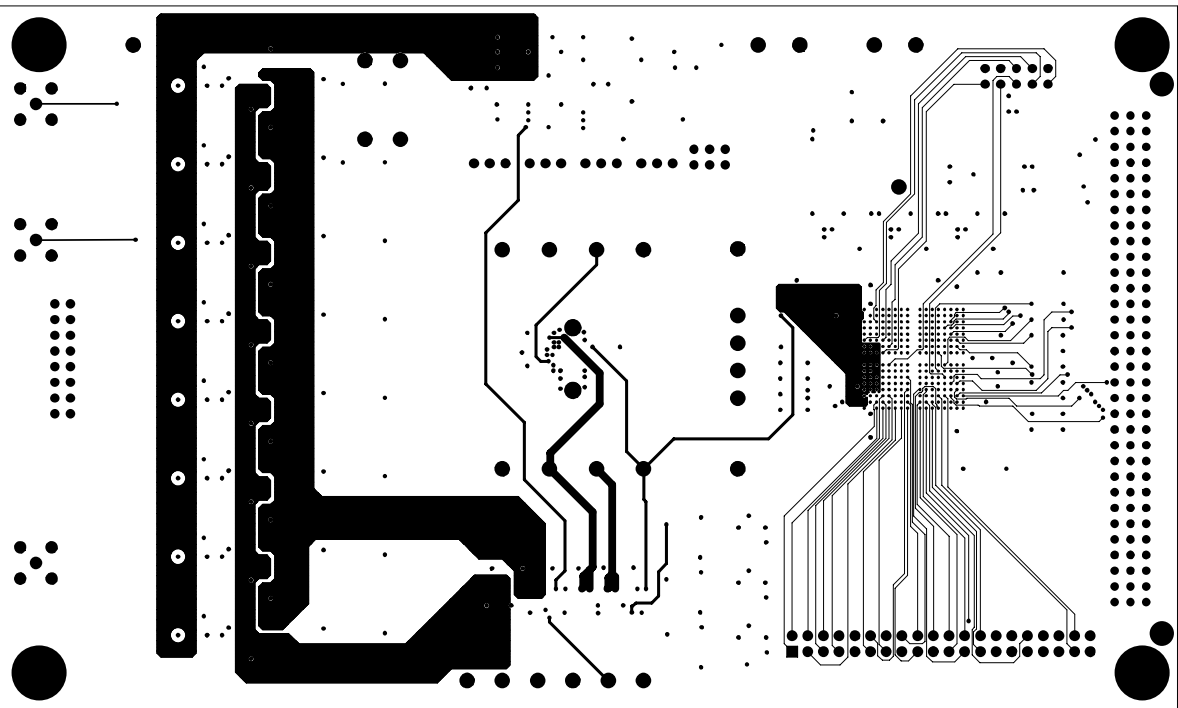

Figure 23. Inner Layer 2  
(Viewed from top side)



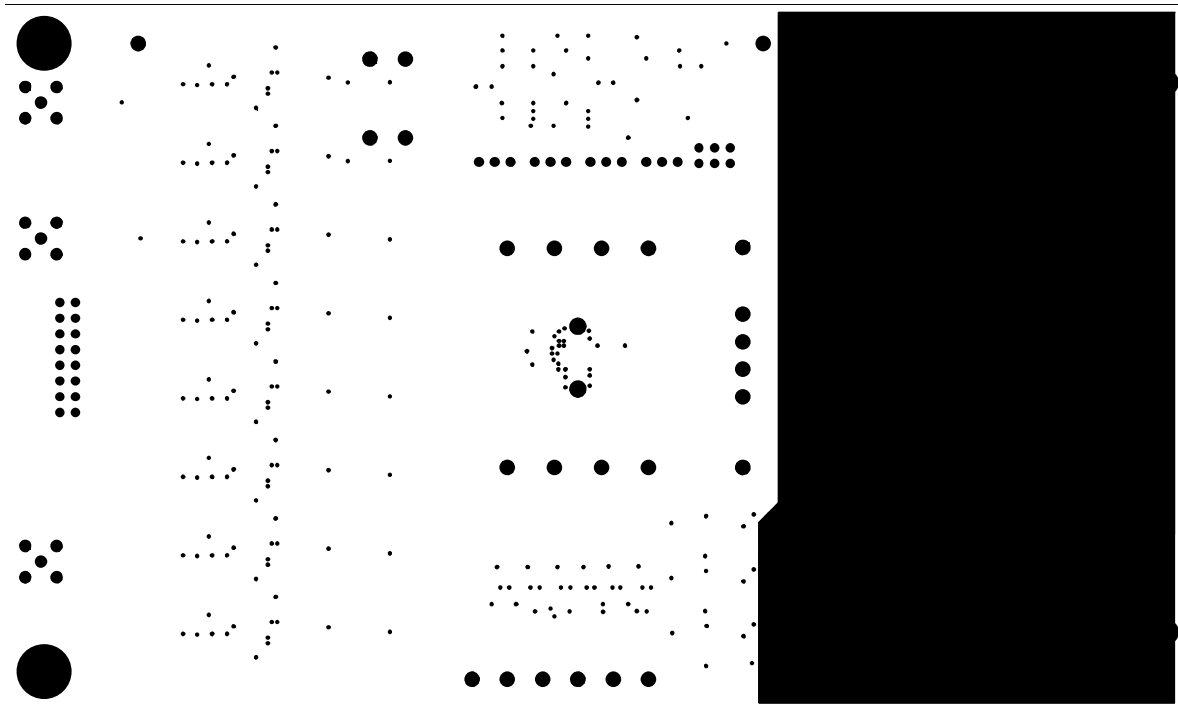

Figure 24. Inner Layer 3  
(Viewed from top side)

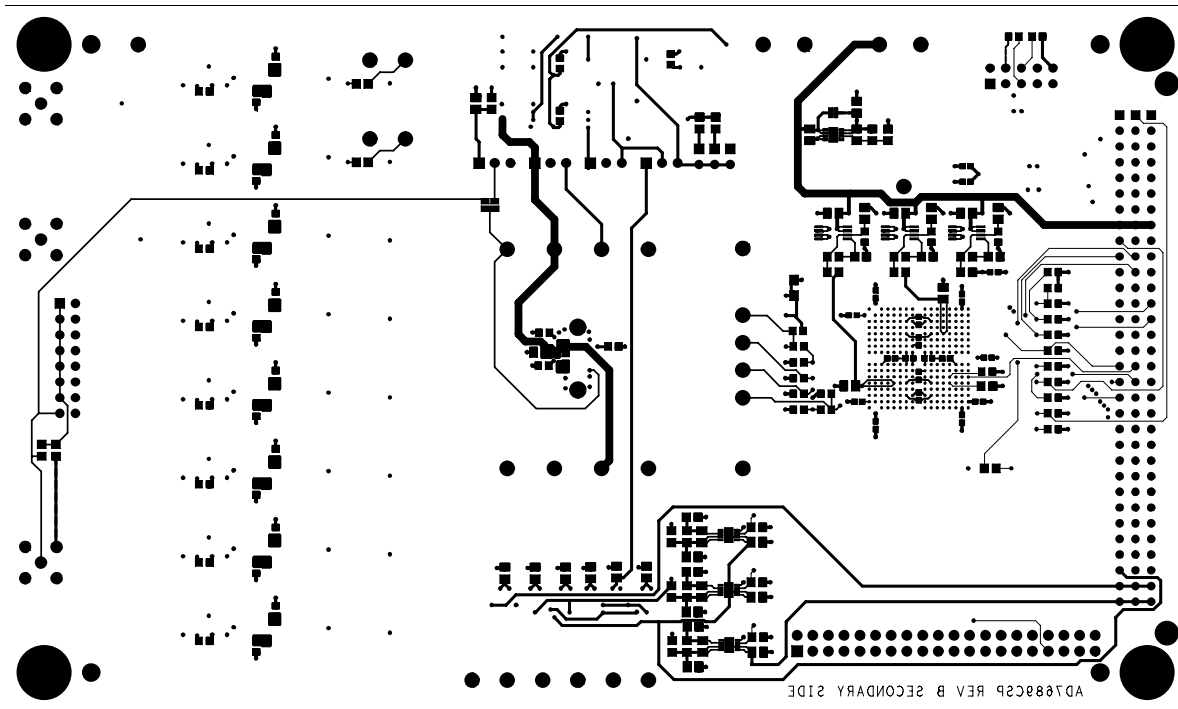

Figure 25. Bottom Layer  
(Viewed from top side)

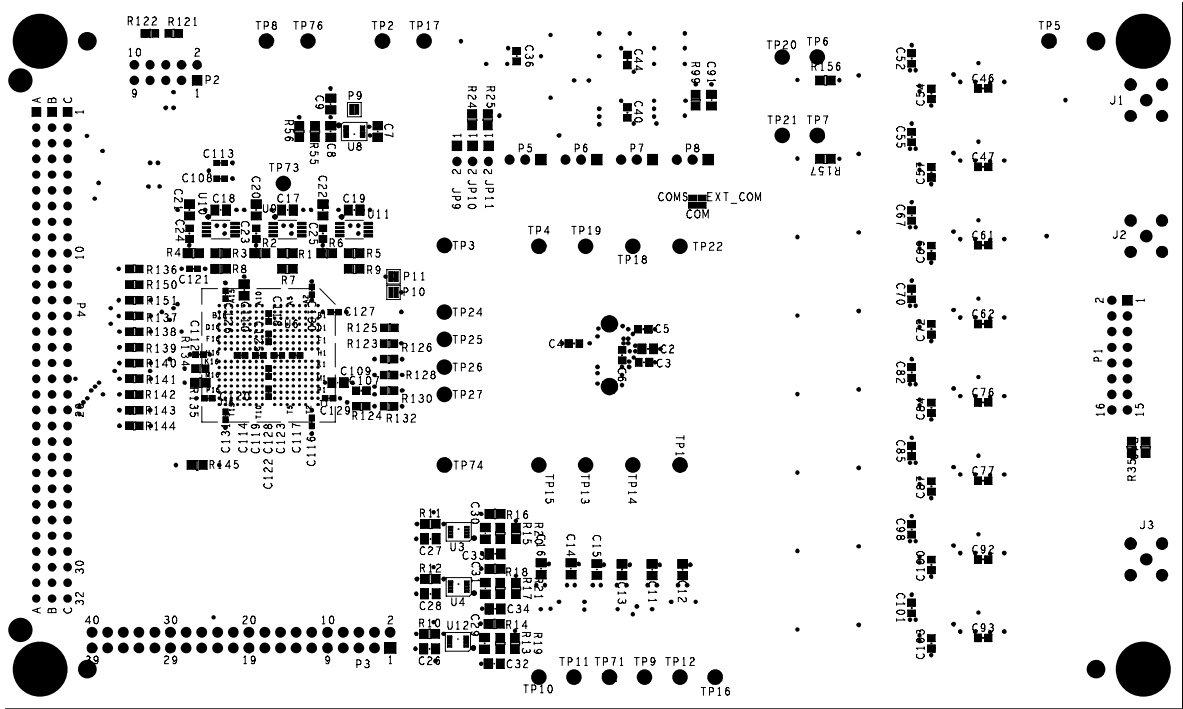

Figure 26. Bottom Layer  
(Viewed from Bottom Side)

**ORDERING GUIDE**

<b>Evaluation Board Model</b>	<b>Product</b>
EVAL-AD7682EDZ	AD7682BCPZ
EVAL-AD7689EDZ	AD7689BCPZ
EVAL-AD7699EDZ	AD7699BCPZ
EVAL-AD7949EDZ	AD7949BCPZ
EVAL-CED1Z	Capture/Controller Board