

DESCRIPTION: COAXIAL / SIGNAL - RIGHT ANGLE - FEMALE

**SPECIFICATIONS:**

**ELECTRICAL:**  
 INSULATOR RESISTANCE: 5,000 MegOHMS Min.  
 DIELECTRIC WITHSTANDING: 1,000VAC r.m.s.  
 OPERATING TEMPERATURE: -55° C ~ +125° C  
 CONTACT RESISTANCE: 30 MilliOHMS Max.  
 COAXIAL PINS: 50 OHM  
 SIGNAL PINS: 5 AMPS

**MECHANICAL:**  
 CONTACT INSERTION FORCE: 4.5 Kg Max.  
 CONTACT SEPARATOR FORCE: 0.3Kg Min.

**MATERIALS:**  
 CONTACTS: BRASS  
 INSULATOR: PBT UL94V-0 RATED,  
 230°C PROCESS TEMP.  
 SHELL: STEEL

**FINISH:**  
 SHELL: NICKEL

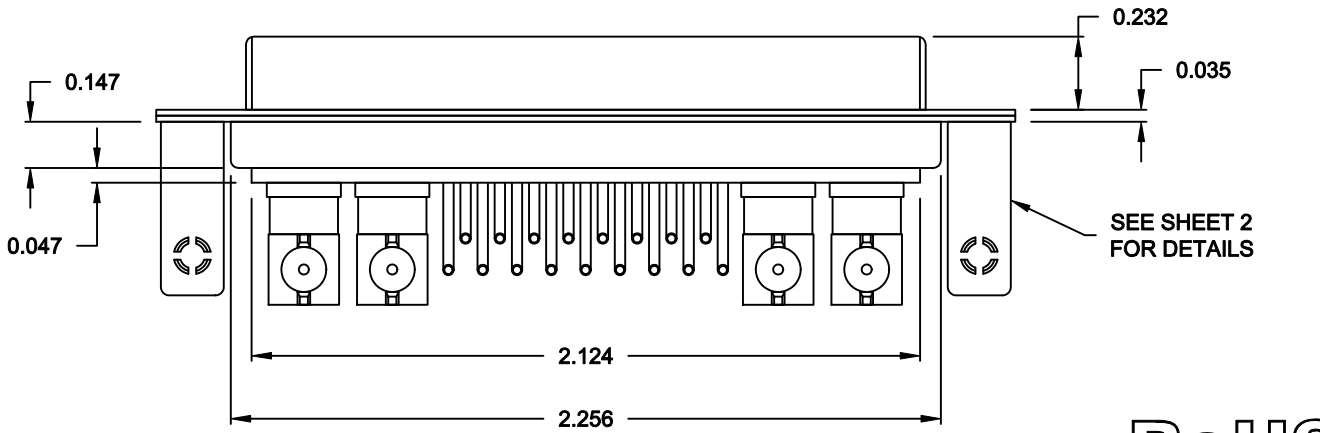
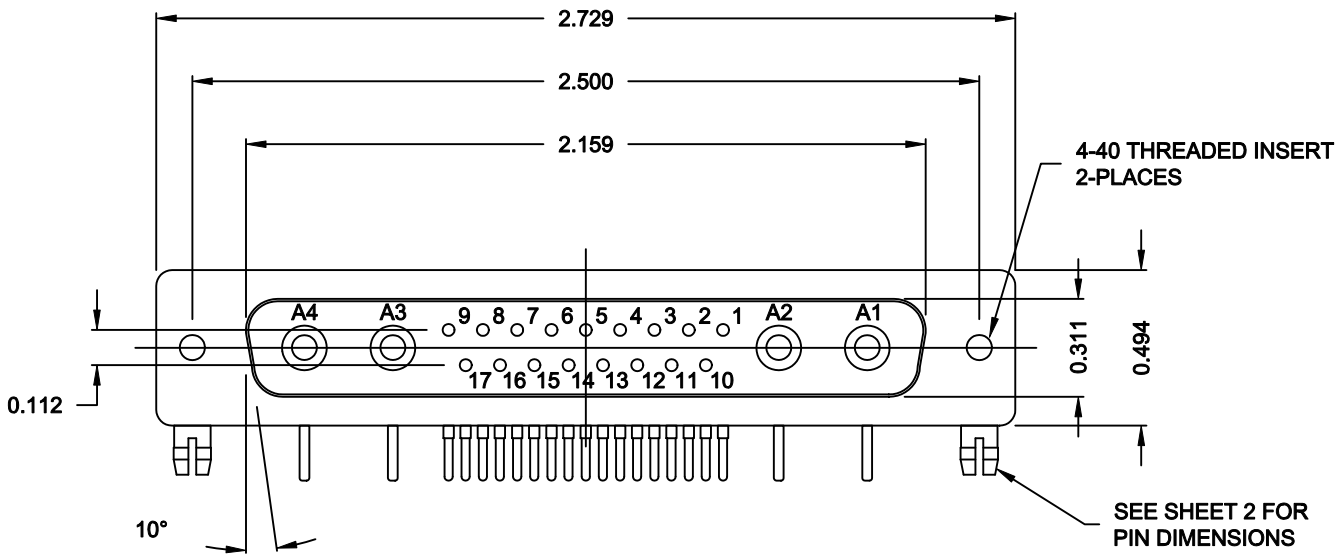

**68521WA4SL461**

46 = 4-40 INSERTS / BOARD LOCKS

**RoHS COMPLIANT**

	THESE DRAWINGS AND SPECIFICATIONS ARE THE PROPERTY OF NorComp AND SHALL NOT BE REPRODUCED, COPIED OR USED AS THE BASIS FOR THE MANUFACTURE OR SALE OF APPARATUS WITHOUT WRITTEN PERMISSION.		DRAWN: <b>C. SMITH</b>	DATE: <b>10-11-06</b>
			CHECKED:	DATE:
<b>NorComp</b>		SCALE: <b>1.5 = 1</b>	SHEET <b>1</b> OF <b>2</b>	REV <b>2</b>
		DWG NO. <b>68521WA4SL461</b>		

DESCRIPTION: 685 SERIES CONTACTS

NOTE:  
POWER CONTACTS COME  
PRE-LOADED INTO INSULATORS

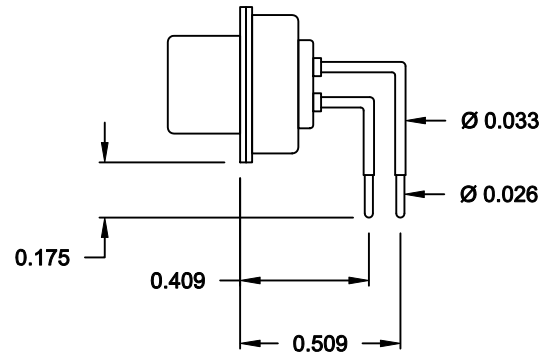
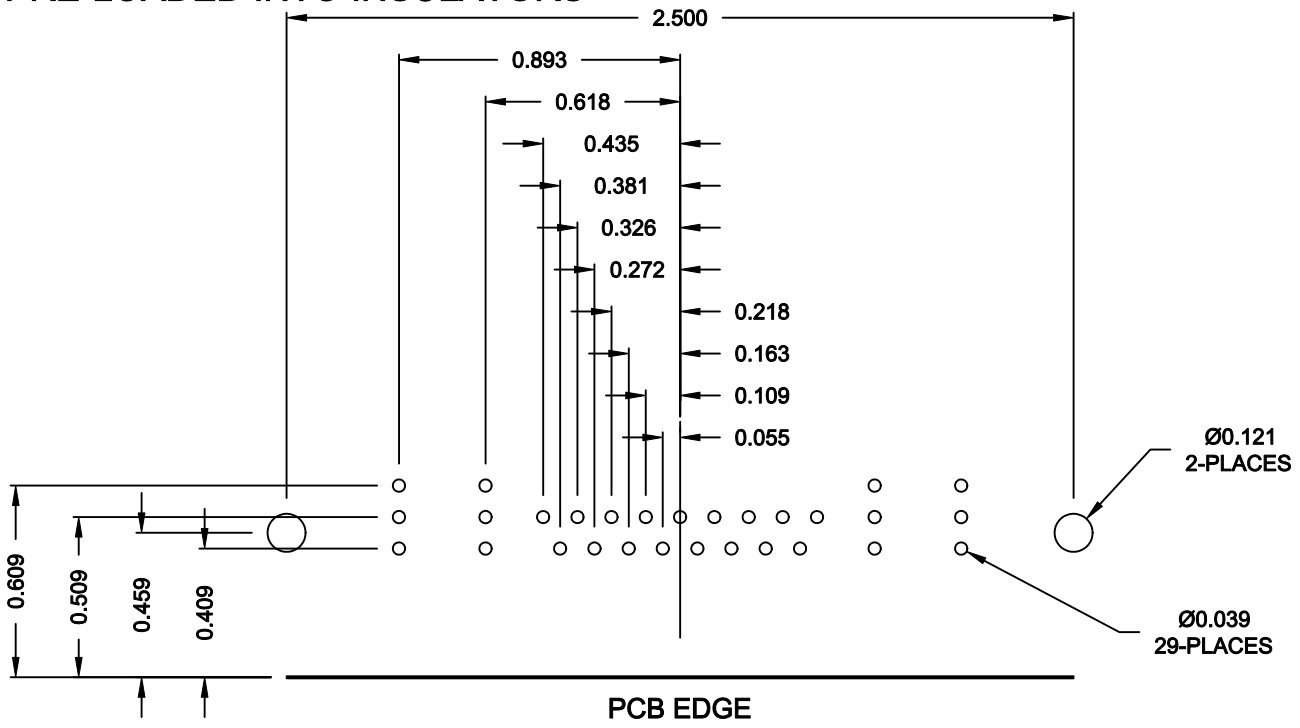

SIGNAL CONTACTS

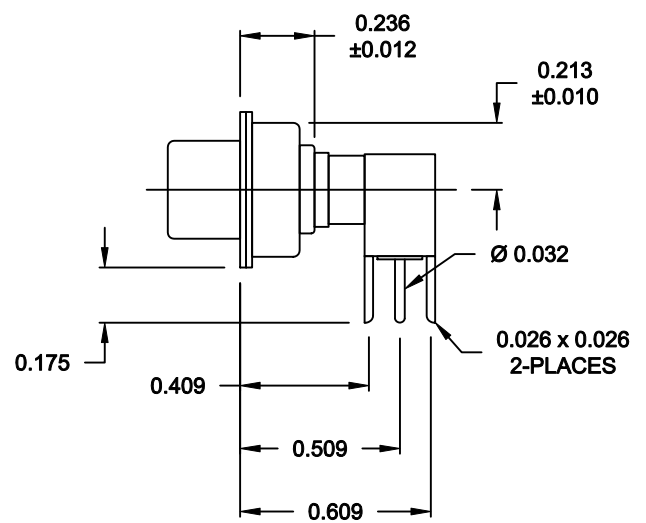

50 OHM COAXIAL CONTACT

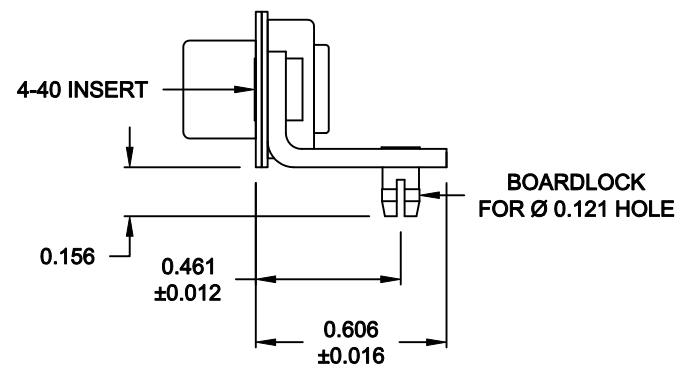

MOUNTING HARDWARE

RoHS COMPLIANT

	THESE DRAWINGS AND SPECIFICATIONS ARE THE PROPERTY OF NorComp AND SHALL NOT BE REPRODUCED, COPIED OR USED AS THE BASIS FOR THE MANUFACTURE OR SALE OF APPARATUS WITHOUT WRITTEN PERMISSION.		DRAWN: <b>C. SMITH</b>	DATE: <b>10-11-06</b>	
	<h1>NorComp</h1>			CHECKED:	DATE:
SCALE: <b>1.5 = 1</b>				SHEET <b>2</b> OF <b>2</b>	REV <b>2</b>
DWG NO. <b>68521WA4SL461</b>					