SEMICONDUCTOR GENERAL CATALOG

東芝半導体製品総覧表2017年1月版

Diodes ダイオード

TVS Diodes (ESD Protection Diodes) / TVSダイオード (ESD保護用ダイオード)

SiC Schottky Barrier Diodes / SiCショットキバリアダイオード

Schottky Barrier Diodes / ショットキバリアダイオード

Rectifiers / 整流用ダイオード

Switching Diodes / スイッチングダイオード

Zener Diodes / ツェナーダイオード

Variable Capacitance Diodes / 可変容量ダイオード

Radio-Frequency Switching Diodes / 高周波スイッチ用ダイオード

TVS Diodes (ESD Protection Diodes) / TVSダイオード (ESD保護用ダイオード)

TVS Diodes (ESD Protection Diodes) / TVSダイオード (ESD保護用ダイオード)

(Standard Type, Unidirectional) / (スタンダードタイプ, 単方向)

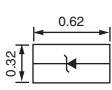
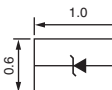
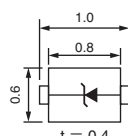
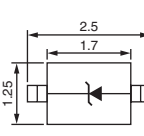
Protected Lines	1 Line				Vz (V)	@Iz (mA)	IR (μA)		Ct (pF)		ESD Immunity (IEC 61000-4-2, Contact Discharge) Min
Package Name (toshiba)	SOD-962 (SL2)	SOD-882 (CST2)	SOD-923	SOD-323 (USC)			Max (V)	@VR (V)	Typ. (V)	@VR (V)	
Package Dimensions and Internal Connections (1)					Typ.		Max	@VR	Typ.	@VR	
	(mm)	(mm)	(mm)	(mm)							
Part Number	DF2S5.1ASL *	DF2S5.1CT	DF2S5.1FS	—	5.1	5	1	1.5	45	0	±30 kV
	DF2S5.6ASL *	DF2S5.6CT	DF2S5.6FS	—	5.6		1	3.5	40	0	
	DF2S6.2ASL *	DF2S6.2CT	DF2S6.2FS	—	6.2		2.5	5	32	0	
	DF2S6.8ASL *	DF2S6.8CT	DF2S6.8FS	—	6.8		0.5	5	25	0	
	DF2S8.2ASL *	DF2S8.2CT	DF2S8.2FS	—	8.2		0.5	6.5	20	0	
	—	—	DF2S10FS	—	10		0.5	8	16	0	±20 kV
	—	—	DF2S12FS	DF2S12FU	12		0.05	9	15	0	
	—	DF2S16CT	DF2S16FS	—	16		0.5	12	10	0	±12 kV
	—	—	—	—	18		0.5	14	10	0	
	—	DF2S20CT	DF2S20FS	—	20		0.5	15	9	0	
—	—	DF2S24FS	—	24	0.5	19	8.5	0	±10 kV		
—	DF2S30CT	DF2S30FS	—	30	2	0.5	23	7 ⁽²⁾	0	±8 kV	

Note (1): The internal connection diagrams only show the general configurations of the circuits. / 内部接続図はイメージ図です。

*: New product / 新製品

(2): DF2S30CT : 7.2 pF(typ.)@0 V

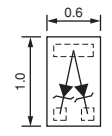
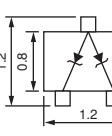
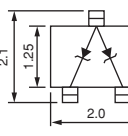
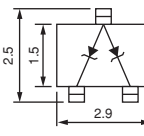
Protected Lines	2 Lines				Vz (V)	@Iz (mA)	IR (μA)		Ct (pF)		ESD Immunity (IEC 61000-4-2, Contact Discharge) Min
Package Name (toshiba)	SOT-883 (CST3)	SOT-723 (VESM)	SOT-323 (USM)	SOT-346 (S-Mini)			Max (V)	@VR (V)	Typ. (V)	@VR (V)	
Package Dimensions and Internal Connections (1)					Typ.		Max	@VR	Typ.	@VR	
	(mm)	(mm)	(mm)	(mm)							
Part Number	DF3A3.3CT	DF3A3.3FV	DF3A3.3FU	—	3.3	5	20 ⁽²⁾	1 ⁽²⁾	115	0	±30 kV
	DF3A3.6CT	DF3A3.6FV	DF3A3.6FU	—	3.6	5	10 ⁽³⁾	1 ⁽³⁾	110	0	
	DF3A5.6CT	DF3A5.6FV	DF3A5.6FU	DF3A5.6F	5.6	5	1	2.5	65	0	
	DF3A6.2CT	DF3A6.2FV	DF3A6.2FU	DF3A6.2F	6.2	5	1	3	55	0	
	DF3A6.8CT	DF3A6.8FV	DF3A6.8FU	DF3A6.8F	6.8	5	0.5	5	45	0	

Note (1): The internal connection diagrams only show the general configurations of the circuits. / 内部接続図はイメージ図です。

(2): DF3A3.3FV : 100 μA(Max)@1.5 V

(3): DF3A3.6FV : 100 μA(Max)@1.8 V

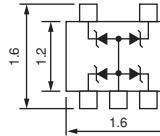
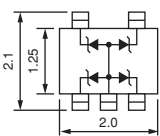
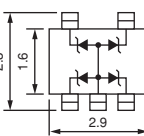
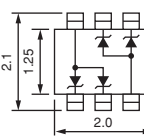
Protected Lines	4 Lines				Vz (V)	@Iz (mA)	IR (μA)		Ct (pF)		ESD Immunity (IEC 61000-4-2, Contact Discharge) Min
Package Name (toshiba)	SOT-553 (ESV)	SOT-353 (USV)	SOT-25 (SMV)	SOT-363 (US6)			Max (V)	@VR (V)	Typ. (V)	@VR (V)	
Package Dimensions and Internal Connections (1)					Typ.		Max	@VR	Typ.	@VR	
	(mm)	(mm)	(mm)	(mm)							
Part Number	DF5A3.3JE	DF5A3.3FU	DF5A3.3F	—	3.3	5	20	1	115	0	±30 kV
	DF5A3.6JE	DF5A3.6FU	DF5A3.6F	—	3.6	5	10	1	110	0	
	DF5A5.6JE	DF5A5.6FU	DF5A5.6F	—	5.6	5	1	2.5	65	0	
	DF5A6.2JE	DF5A6.2FU	DF5A6.2F	—	6.2	5	1	3	55	0	
	DF5A6.8JE	DF5A6.8FU	DF5A6.8F	DF6A6.8FU	6.8	5	0.5	5	45	0	

Note (1): The internal connection diagrams only show the general configurations of the circuits. / 内部接続図はイメージ図です。

(Standard Type, Bidirectional) / (スタンダードタイプ, 双方向)

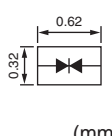
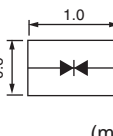
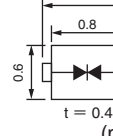
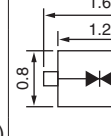
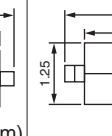
Protected Lines	Single Type					V_{BR} (V)		I_R (μ A)		C_t (pF)		ESD Immunity (IEC 61000-4-2, Contact Discharge) Min
Package Name (toshiba)	SOD-962 (SL2)	SOD-882 (CST2)	SOD-923	SOD-523 (ESC)	SOD-323 (USC)	Typ.	@ I_{BR} (mA)	Max	@ V_{RWM} (V)	Typ.	@ V_R (V)	
Package Dimensions and Internal Connections (1)												
Part Number	—	—	—	DF2B6.8E	—	6.8	1	0.5	5	15	0	± 8 kV
	—	DF2B6.8ACT	DF2B6.8AFS	—	—	6.8	1	0.5	5	9	0	± 30 kV
	DF2B7SL	—	—	—	—	6.8	1	0.5	5.3	6	0	± 17 kV
	DF2B7ASL *	DF2B7ACT *	DF2B7AFS *	DF2B7AE *	DF2B7AFU *	5.8	1	0.1	5.5	8.5	0	± 30 kV

Note (1): The internal connection diagrams only show the general configurations of the circuits. / 内部接続図はイメージ図です。

*: New product / 新製品

(High-Speed Type) / (ハイスピードタイプ)

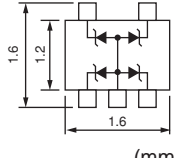
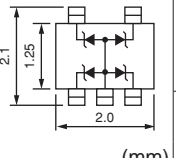
Protected Lines	4 Lines		V_z (V)		I_R (μ A)		C_t (pF)		ESD Immunity (IEC 61000-4-2, Contact Discharge) Min
Package Name (toshiba)	SOT-553 (ESV)	SOT-353 (USV)	Typ.	@ I_z (mA)	Max	@ V_R (V)	Typ.	@ V_R (V)	
Package Dimensions and Internal Connections (1)									
Part Number	DF5A3.6CJE	DF5A3.6CFU	3.6	5	100	1.8	52	0	± 30 kV
	DF5A5.6CJE	DF5A5.6CFU	5.6	5	1	3.5	29	0	
	DF5A6.2CJE	DF5A6.2CFU	6.2	5	2.5	5	25	0	± 25 kV
	DF5A6.8CJE	DF5A6.8CFU	6.8	5	0.5	5	23	0	

Note (1): The internal connection diagrams only show the general configurations of the circuits. / 内部接続図はイメージ図です。

(Super-High-Speed Type) / (スーパーハイスピードタイプ)

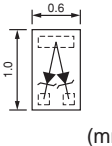
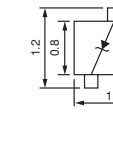
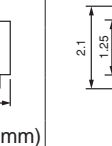
Protected Lines	2 Lines			V_z (V)		I_R (μ A)		C_t (pF)		ESD Immunity (IEC 61000-4-2, Contact Discharge) Min
Package Name (toshiba)	SOT-883 (CST3)	SOT-723 (VESM)	SOT-323 (USM)	Typ.	@ I_R (mA)	Max	@ V_R (V)	Typ.	@ V_R (V)	
Package Dimensions and Internal Connections (1)										
Part Number	—	DF3A5.6LFV	DF3A5.6LFU	5.6	5	1	3.5	8	0	± 8 kV
	—	DF3A6.2LFV	DF3A6.2LFU	6.2	5	2.5	5	6.5	0	
	DF3A6.8LCT	DF3A6.8LFV	DF3A6.8LFU	6.8	5	0.5	5	6 ⁽²⁾	0	

Note (1): The internal connection diagrams only show the general configurations of the circuits. / 内部接続図はイメージ図です。

(2): DF3A6.8LCT : 5.5 pF(typ.)@0 V

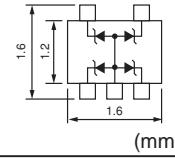
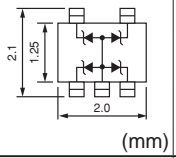
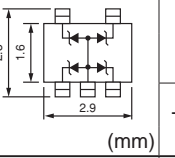
Protected Lines	4 Lines			V_z (V)		I_R (μ A)		C_t (pF)		ESD Immunity (IEC 61000-4-2, Contact Discharge) Min
Package Name (toshiba)	SOT-553 (ESV)	SOT-353 (USV)	SOT-25 (SMV)	Typ.	@ I_z (mA)	Max	@ V_R (V)	Typ.	@ V_R (V)	
Package Dimensions and Internal Connections (1)										
Part Number	DF5A5.6LJE	DF5A5.6LFU	—	5.6	5	1	3.5	8	0	± 8 kV
	DF5A6.2LJE	DF5A6.2LFU	—	6.2	5	2.5	5	6.5	0	
	DF5A6.8LJE	DF5A6.8LFU	DF5A6.8LF	6.8	5	0.5	5	6	0	

Note (1): The internal connection diagrams only show the general configurations of the circuits. / 内部接続図はイメージ図です。

TVS Diodes (ESD Protection Diodes) / TVSダイオード (ESD保護用ダイオード)
(Ultra-High-Speed Type, Unidirectional) / (ウルトラハイスピードタイプ, 単方向)

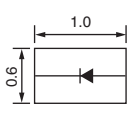
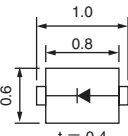
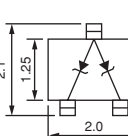
Protected Lines	4 Lines		2 Lines	V_{BR} (V)			I_R (μA)		C_t (pF)			ESD Immunity (IEC 61000-4-2, Contact Discharge) Min
	Package Name (toshiba)	SOD-882 (CST2)	SOD-923									
Package Dimensions and Internal Connections (1)				@ I_{BR}	@ V_{RWM}	@ V_R						
Part Number	DF2S6.8UCT	DF2S6.8UFS	—	5.3	6.8	1	0.5	5	—	1.6	0	±8 kV
	—	—	DF3A6.8UFU	5.3	6.8	1	0.5	5	2.5	—	0	
	DF2S24UCT	—	—	22	24	1	0.5	19	—	1.6	0	

Note (1): The internal connection diagrams only show the general configurations of the circuits. / 内部接続図はイメージ図です。

(Ultra-High-Speed Type, Bidirectional) / (ウルトラハイスピード, 双方向)

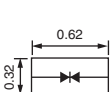
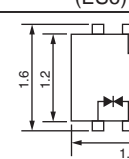
Protected Lines	2 Lines	1 Line	V_{BR} (V)			I_R (μA)		C_t (pF)		ESD Immunity (IEC 61000-4-2, Contact Discharge) Min
	Package Name (toshiba)	SOD-962 (SL2)								
Package Dimensions and Internal Connections (1)			@ I_{BR}	@ V_{RWM}	@ V_R					
Part Number	DF2B6USL *	DF6D6UFE *	5.7	1	0.1	5.5	1.5	0	±10 kV	

Note (1): The internal connection diagrams only show the general configurations of the circuits. / 内部接続図はイメージ図です。

*: New product / 新製品

(Extra-High-Speed Type, Unidirectional) / (エクストラハイスピードタイプ, 単方向)

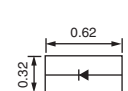
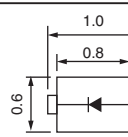
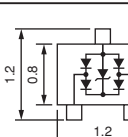
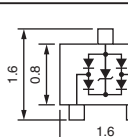
Protected Lines	1 Line		2 Lines		V_{BR} (V)			I_R (μA)		C_t (pF)		ESD Immunity (IEC 61000-4-2, Contact Discharge) Min
	Package Name (toshiba)	SOD-962 (SL2)	SOD-923	SOT-723 (VESM)								
Package Dimensions and Internal Connections (1)					@ I_{BR}	@ V_{RWM}	@ V_R					
Part Number	DF2S5M4SL *	—	—	—	3.7	1	0.1	3.6	0.35	0	±20 kV	
	DF2S6M4SL *	—	—	—	5.6	1	0.1	5.5	0.35	0	±20 kV	
	—	—	DF3D6.8MFV *	DF3D6.8MS	6	5	0.5	5	0.5	0	±8 kV	
	DF2S7MSL *	DF2S6.8MFS	—	—	6	5	0.5	5	0.5	0	±12 kV	

Note (1): The internal connection diagrams only show the general configurations of the circuits. / 内部接続図はイメージ図です。

*: New product / 新製品

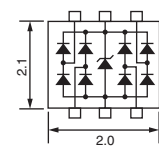
Protected Lines	4 Lines + V_{BUS}	V_{BR} (V)			I_R (μA)		C_t (pF)		ESD Immunity (IEC 61000-4-2, Contact Discharge) Min
	Package Name (toshiba)								
Package Dimensions and Internal Connections (1)		@ I_{BR}	@ V_{RWM}	@ V_R					
Part Number	DF6F6.8MTU	6	5	0.5	5	0.6	0	±8 kV	

Note (1): The internal connection diagrams only show the general configurations of the circuits. / 内部接続図はイメージ図です。

(Extra-High-Speed Type, Bidirectional) / (エクストラハイスピードタイプ, 双方向)

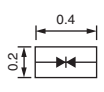
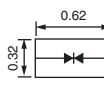
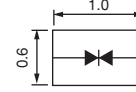
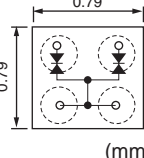
Protected Lines	1 Line			2 Lines	V_{BR} (V)		I_R (μ A)		C_t (pF)		ESD Immunity (IEC 61000-4-2, Contact Discharge) Min
Package Name (toshiba)	SOD-992 (CL2)	SOD-962 (SL2)	SOD-882 (CST2)	— (WCSP4)	Min	@IBR	Max	@VRWM	Typ.	@VR	
Package Dimensions and Internal Connections (1)						(mA)		(V)		(V)	
Part Number	DF2B7M2CL *	DF2B7M2SL *	(DF2B6.8M1ACT)	DF4D7M2G *	6	1	0.05 (0.5)	5	0.2 (0.3)	0	± 12 kV
	—	—	(DF2B12M1CT)	—	10	1	0.05	8	0.2 (0.3)	0	± 8 kV
	DF2B7M3CL **	DF2B7M3SL *	—	—	6	1	0.5	5.5	0.1	0	± 12 kV
	DF2B5M4CL **	DF2B5M4SL *	—	—	4	1	0.1	3.6	0.2	0	± 20 kV
	DF2B6M4CL **	DF2B6M4SL *	—	—	5.6	1	0.1	5.5	0.2	0	± 20 kV
	—	DF2B20M4SL *	—	—	19.5	1	0.1	18.5	0.3	0	± 15 kV

Note (1): The internal connection diagrams only show the general configurations of the circuits. / 内部接続図はイメージ図です。

*: New product / 新製品

** : Under development / 開発中

(Extra-High-Speed Type, Flow-Through) / (エクストラハイスピードタイプ, フロースルー)

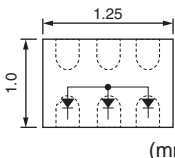
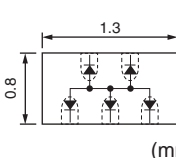
Protected Lines	2 Lines		4 Lines		V_{BR} (V)		I_R (μ A)		C_t (pF)		ESD Immunity (IEC 61000-4-2, Contact Discharge) Min
Package Name (toshiba)	— (DFN6)		— (DFN5)		Min		@IBR	Max		@VRWM	
Package Dimensions and Internal Connections (1)					(mA)		(V)	(V)		@VR	
Part Number	DF6D7M1N	—	—	DF10G7M1N	6	1	0.5	5	0.3	0	± 12 kV
	—	DF5G7M2N *	—	—	6	1	0.5	5.5	0.2	0	± 20 kV
	DF6D5M4N *	DF5G5M4N **	—	DF10G5M4N *	4	1	0.1	3.6	0.2	0	
	DF6D6M4N *	DF5G6M4N **	—	DF10G6M4N *	5.6	1	0.1	5.5	0.2	0	

Note (1): The internal connection diagrams only show the general configurations of the circuits. / 内部接続図はイメージ図です。

*: New product / 新製品

** : Under development / 開発中

(Automotive Interface Applications, Bidirectional) / (車載インタフェース向け, 双方向)

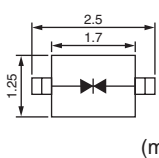
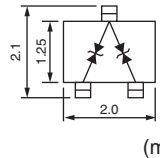
Protected Lines	1 Line	2 Lines	V_{BR} (V)		I_R (μ A)		C_t (pF)		ESD Immunity (IEC 61000-4-2, Contact Discharge) Min
Package Name (toshiba)	SOD-323 (USC)	SOT-232 (USM)	Min	@IBR	Max	@VRWM	Typ.	@VR	
Package Dimensions and Internal Connections (1)				(mA)		(V)		(V)	
Part Number	DF2B18FU *	DF3D18FU *	16.2	1	0.1	12	9	0	± 30 kV
	DF2B29FU *	DF3D29FU *	26	1	0.1	24	9	0	± 25 kV
	DF2B36FU *	DF3D36FU *	32	1	0.1	28	7	0	± 20 kV

Note (1): The internal connection diagrams only show the general configurations of the circuits. / 内部接続図はイメージ図です。

*: New product / 新製品

SiC Schottky Barrier Diodes / SiCショットキバリアダイオード

SiC Schottky Barrier Diodes / SiCショットキバリアダイオード

Design	Absolute Maximum Ratings		Package	Part Number	Electrical Characteristics (Ta = 25°C)				
	VRRM (V)	IF (DC) (A)			VF (V)		Cj (pF)	IRRM (μA)	
					@IF (DC)		@650V/1 MHz	@VRRM	
					Typ.	Max	Typ.	Max	
1 st	650	6	TO-220-2L	TRS6E65C	1.5	1.7	35	90	
		8		TRS8E65C	1.5	1.7	44	90	
		10		TRS10E65C	1.5	1.7	55	90	
		12		TRS12E65C	1.54	1.7	65	90	
		6	TO-220F-2L Isolation	TRS6A65C	1.5	1.7	35	90	
		8		TRS8A65C	1.5	1.7	44	90	
		10		TRS10A65C	1.5	1.7	55	90	
		12		TRS12A65C	1.54	1.7	65	90	
	16	TRS16A65C	1.5	1.7	88	90			
	12	TO-247	TRS12N65D	1.5	1.7	35 ⁽¹⁾	90		
	16		TRS16N65D	1.5	1.7	44 ⁽¹⁾	90		
	20		TRS20N65D	1.5	1.7	55 ⁽¹⁾	90		
	24		TRS24N65D	1.54	1.7	65 ⁽¹⁾	90		
	1200	20	TO-3P (N)	TRS20J120C	1.5	1.7	105 ⁽²⁾	90	
	2 nd	650	2	TO-220-2L	TRS2E65F **	(1.45)	(1.6)	(8)	(20)
			3		TRS3E65F **	(1.45)	(1.6)	(13)	(20)
4			TRS4E65F		1.45	1.6	16	20	
6			TRS6E65F		1.45	1.6	22	30	
8			TRS8E65F		1.45	1.6	28	40	
10			TRS10E65F		1.45	1.6	36	50	
4			TO-220F-2L Isolation	TRS4A65F	1.45	1.6	16	20	
6				TRS6A65F	1.45	1.6	22	30	
8				TRS8A65F	1.45	1.6	28	40	
10				TRS10A65F	1.45	1.6	36	50	
2		DPAK	TRS2P65F **	(1.45)	(1.6)	(8)	(20)		
3			TRS3P65F **	(1.45)	(1.6)	(13)	(20)		
4			TRS4P65F **	(1.45)	(1.6)	(16)	(20)		
6			TRS6P65F **	(1.45)	(1.6)	(22)	(30)		
8			TRS8P65F **	(1.45)	(1.6)	(28)	(40)		
10			TRS10P65F **	(1.45)	(1.6)	(36)	(50)		

Note (1): Per diode / 2素子中 1素子あたりの値

** : Under development / 開発中

(2): @VR = 600 V/μH = 1 MHz

Packages / パッケージ

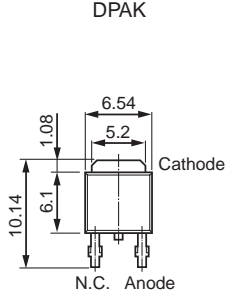
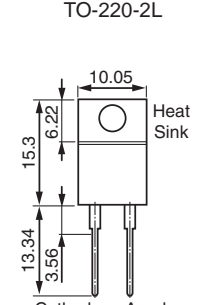
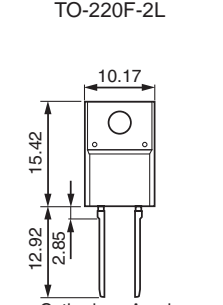
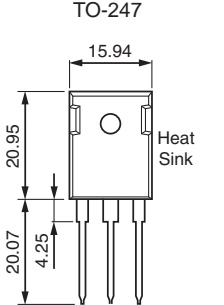
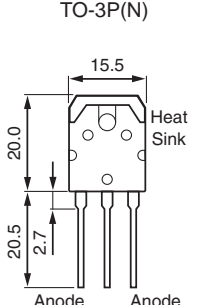
 <p>DPAK</p> <p>(mm)</p>	 <p>TO-220-2L</p> <p>(mm)</p>	 <p>TO-220F-2L</p> <p>(mm)</p>	 <p>TO-247</p> <p>(mm)</p>	 <p>TO-3P(N)</p> <p>(mm)</p>
--	--	---	--	---

Schottky Barrier Diodes / ショットキバリアダイオード















Schottky Barrier Diodes (SBDs) / 整流用ショットキバリアダイオード (SBD)

		Package	Peak Repetitive Reverse Voltage (V)			
			20	30	40	60
Average Forward Current (A)	0.7	US-FLAT			CUS03	CUS04
	1	US-FLAT	CUS05 CUS06	CUS01 CUS02 CUS10I30A	CUS10I40A	
		S-FLAT	CRS06	CRS01 CRS03 CRS05 CRS11 CRS10I30A CRS10I30B CRS10I30C	CRS04 CRS10I40A CRS10I40B	CRS12 CRS13
		M-FLAT		CMS08 CMS09 CMS10I30A	CMS10 CMS10I40A	
	1.5	US-FLAT		CUS15I30A		
		S-FLAT		CRS08 CRS09 CRS15I30A CRS15I30B	CRS15I40A	
		M-FLAT			CMS15I40A	
	2	S-FLAT		CRS14 CRS20I30A CRS20I30B	CRS20I40A CRS20I40B	
		M-FLAT		CMS06 CMS07 CMS17 CMS20I30A	CMS11 CMS20I40A	CMS14
	3	S-FLAT		CRS15 CRS30I30A	CRS30I40A	
		M-FLAT		CMS01 CMS03 CMS30I30A	CMS16 CMS30I40A	CMS15
	5	M-FLAT		CMS04 CMS05		

・ The products shown in bold are manufactured in offshore fabs.























・ 太字製品は当社海外工場にて生産しております。

Small-Signal Schottky Barrier Diodes and Multiple Schottky Barrier Diodes /
 小信号ショットキバリアダイオード, 複合ショットキバリアダイオード









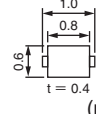

Absolute Maximum Ratings		Electrical Characteristics (Ta = 25°C)					CST2	SOD-923	ESC	USC	VESM	SSM
VR (V)	Io (mA)	VF (V)		@IF (mA)	IR (μA)		 (mm)	 (mm)	 (mm)	 (mm)	 (mm)	 (mm)
		Typ.	Max		Max	@VR (V)						
10	50	0.63	1.0	50	0.5	10						
10	100	0.23	0.3	5	20	10			1SS389	1SS367		
		0.35	0.5	100								
10	100	0.23	0.3	5	20	10					1SS385FV	1SS385
		0.35	0.5	100								
10	100	0.23	0.3	5	20	10						
		0.35	0.5	100								
20	50	0.33	—	1	0.5	20	1SS413CT	1SS413	1SS405	1SS406		
		0.5	0.55	50								
20	200	0.42	0.5	200	50	20			1SS424			
20	300	0.16	—	1	50	20				1SS404		
		0.38	0.45	300								
40	100	0.28	—	1	5	40						
		0.54	0.6	100								

• The internal connection diagrams only show the general configurations of the circuits.

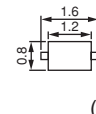









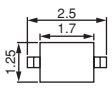
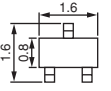
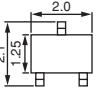
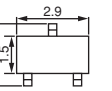
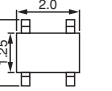
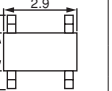
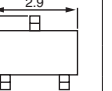

















• 内部接続図はイメージ図です。

USM (SC-70)	S-MINI (SC-59)	USQ	SMQ (SC-61)	US6 (SOT-363)	SM6 (SC-74)	Remarks
						
(mm)	(mm)	(mm)	(mm)	(mm)	(mm)	
	1SS321					Low leakage current, Common cathode
						
1SS395	1SS394	1SS384	1SS391	HN2S01FU	HN2S01F	Low V_F , Independent diodes
						
1SS378	1SS377					Low V_F , Common cathode
						
1SS372	1SS374					Low V_F , Series-connected
						
		1SS402		HN2S03FU		Low leakage current, High-speed SW
						
						Low I_r
1SS401				HN2S04FU		Low V_F , High current
						
				HN2S02FU		Standard
						

Small-Signal Schottky Barrier Diodes and Multiple Schottky Barrier Diodes /
 小信号ショットキバリアダイオード, 複合ショットキバリアダイオード

Absolute Maximum Ratings		Electrical Characteristics (Ta = 25°C)					SL2	CST2	CST2C	SOD-923	CST2B	ESC	
VR (V)	Io (mA)	VF (V)		@IF (mA)	IR (μA)		 (mm)	 (mm)	 (mm)	 (mm)	 (mm)	 (mm)	
		Typ.	Max		Max	@VR (V)							
30	100	0.38	0.5	100	20	10		1SS416CT	1SS416				
30	100	0.27	0.3	10	7	10	DSF01S30SL *						
		0.41	0.5	100	50	30							
30	100	0.37	0.5	10	0.35	10	DSR01S30SL *						
		0.51	0.62	100	0.7	30							
30	200	0.52	0.6	200	5	30		CTS520			CES520		
30	200	0.45	0.5	200	30	30		CTS521			CES521		
30	200	0.45	0.58	100	2	25							
30	500	0.38	0.45 (0.47)	500	50	30				CBS05F30			
30	500	0.41	0.47	500	300	30		CTS05S30 *					
30	800	0.40	0.45	800	50	30							
30	1000	0.43	0.5	1000	50	30							
30	1000	0.37	0.45	1000	500	30				CBS10S30 *			
30	1500	0.33	0.4	1000	500	30			CCS15S30				
		0.39	—	1500									
40	100	0.54 (0.56)	0.6 (0.62)	100	5	40		(1SS417CT)	(1SS417)		CES388		
40	100	0.54	0.6	100	5	40							
40	100	0.54 (0.56)	0.6 (0.62)	100	5	40							
40	500	0.53 (0.56)	0.6	500	50	40		CTS05S40 *					
40	1000	0.45 (0.48)	0.50 (0.55)	1000	150	40				(CBS10S40) *			
40	1000	0.60 (0.63)	0.67 (0.7)	1000	20	40				(CBS10F40) *			
40	1000	0.74	0.81	500	15	40		CTS05F40 *					
40	1500	0.40	0.45	1000	200	40			CCS15S40 *				
		0.47	0.55	1500									
40	1500	0.50	0.55	1000	25	40			CCS15F40 *				
		0.59	0.64	1500									





- The VF ratings enclosed in parentheses are for those devices whose part numbers are enclosed in parentheses.
- The internal connection diagrams only show the general configurations of the circuits.
- () 内品種はVF特性が異なります。
- 内部接続図はイメージ図です。

USC  (mm)	SSM  (mm)	USM (SC-70)  (mm)	S-MINI (SC-59)  (mm)	USQ  (mm)	SMQ (SC-61)  (mm)	SOT23  (mm)	Remarks
	1SS422 						Low V _F
							Low V _F
							Low I _R
CUS520 							Low I _R
CUS521 							Low V _F
						TBAT54 * 	Low I _R , single
						TBAT54A * 	Low I _R , common anode
						TBAT54C * 	Low I _R , common cathode
						TBAT54S * 	Low I _R , series-connected
(CUS551V30) 							Low V _F
CUS05S30 * 							High current, single, very Low-V _F
CUS08F30 							High current, single Improved V _F and I _R
CUS10F30 							High current, single Improved V _F and I _R
CUS10S30 * 							High current, single, very Low-V _F
CUS15S30 * 							High current, single, very Low-V _F
CUS357 		1SS322 	1SS294 	1SS383 	1SS319 		Standard, Independent diodes
		1SS393 	1SS392 				Standard, common cathode
	(1SS423) 		1SS396 				Standard, series-connected
CUS05S40 * 							High current, single, very Low-V _F
CUS10S40 * 							High current, single, very Low-V _F
CUS10F40 * 							High current, single Improved V _F and I _R
CUS05F40 * 							High current, single Improved V _F and I _R
CUS15S40 * 							High current, single Improved V _F and I _R
CUS15F40 ** 							High current, single Improved V _F and I _R

*: New product / 新製品

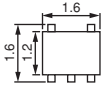
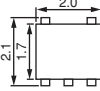
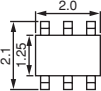
** : Under development / 開発中

Small-Signal Schottky Barrier Diodes and Multiple Schottky Barrier Diodes / 小信号ショットキバリアダイオード, 複合ショットキバリアダイオード

Absolute Maximum Ratings		Electrical Characteristics (Ta = 25°C)					ESV	UFV	US6	Remarks
VR (V)	Io (mA)	VF (V)		@IF (mA)	IR (μA)		 (mm)	 (mm)	 (mm)	
		Typ.	Max		Max	@VR (V)				
30	1000	0.47	0.57	1000	50	30		CVJ10F30 	High current, single Improved VF and IR	
40	100	0.54 (0.56)	0.6 (0.62)	100	5	40	HN2S02JE 	HN2S02FU 	Standard, Independent diodes	

• The internal connection diagrams only show the general configurations of the circuits.

• 内部接続図はイメージ図です。

Radio-Frequency Schottky Barrier Diodes / 高周波用ショットキバリアダイオード

Part Number	Applications	VR ♣VRM (V)	IF (mA)	VF(Typ.)		CT(Typ.)		Package
				(V)	IF (mA)	(pF)	VR (V)	
1SS154	VHF to S band mixer	6	30	0.5	10	0.8	0	S-Mini (Single)
1SS271		6	30	0.5	10	0.8	0	S-Mini (Twin)
1SS295	UHF MIXER	4	30	0.25	2	0.6	0.2	S-Mini (Twin)
1SS315		♣5	30	0.25	2	0.6	0.2	USC
JDH2S01FS		4	25	0.25	2	0.6	0.2	fSC
JDH3D01S		4	25	0.25	2	0.6	0.2	SSM (Twin)
JDH3D01FV		4	25	0.25	2	0.6	0.2	VESM (Twin)
JDH2S02FS		10	10	0.24	1	0.3	0.2	fSC
JDH2S02SC		10	10	0.24	1	0.3	0.2	SC2
JDH2S02SL *		10	10	0.24	1	0.3	0.2	SL2

*: New product / 新製品

Rectifiers / 整流用ダイオード

General-Purpose Rectifiers / 一般整流用ダイオード

Average Forward Current (A)	Package	Peak Repetitive Reverse Voltage (V)			Remarks
		400	600	800	
0.7	HM-FLAT	HMG02			Independent 2-in-1
	S-FLAT	CRG07			
1	S-FLAT	CRG03 CRG09 (1)	CRG04	CRG05	
	M-FLAT	CMG05 CMG07	CMG06 CMG08		
2	M-FLAT	CMG02	CMG03		

Note (1): High ESD protection / 高静電気耐量タイプ

- ・ The products shown in bold are manufactured in offshore fabs.
- ・ 太字製品は当社海外工場にて生産しております。

(For Strobe Discharge Circuits) / (ストロボフラッシュ放電回路用)

Peak Repetitive Forward Current	Peak Repetitive Reverse Voltage	Part Number	Package	Remarks
I_{FRM} (A)	V_{RRM} (V)			
150	400	CMC02	M-FLAT	CM = 500 μ F

- ・ The products shown in bold are manufactured in offshore fabs.
- ・ 太字製品は当社海外工場にて生産しております。

Super-Fast-Recovery Diodes (S-FRDs) / 超高速整流用ダイオード (S-FRD)

Average Forward Current (A)	Package	Reverse Recovery Time t_{rr} (ns) (Max)	Peak Repetitive Reverse Voltage (V)			
			600	800	900	1000
0.5	S-FLAT	100		CRF02		
	M-FLAT			CMF04	CMF03	CMF05 ☆
0.7	S-FLAT		CRF03			
1	M-FLAT		CMF02			
2	M-FLAT		CMF01			

☆: Dry-packed / 防湿梱包品

- ・ The products shown in bold are manufactured in offshore fabs.
- ・ 太字製品は当社海外工場にて生産しております。











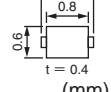
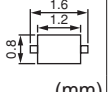
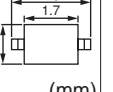

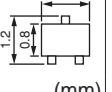
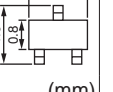
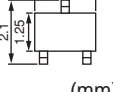
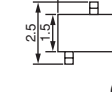
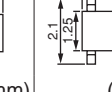























High-Efficiency Diodes (HEDs) / 高速高効率ダイオード (HED)

Average Forward Current (A)	Package	Reverse Recovery Time t_{rr} (ns) (Max)	Peak Repetitive Reverse Voltage (V)
			200
0.5	S-FLAT	35	CRH02
1	S-FLAT		CRH01
	M-FLAT		CMH04
2	M-FLAT	35	CMH07
3		35	CMH01











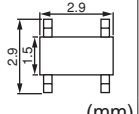
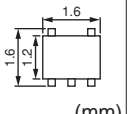
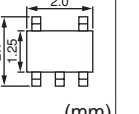
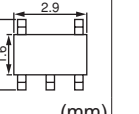
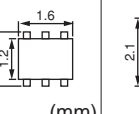
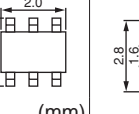
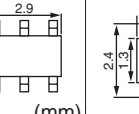
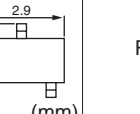















- ・ The products shown in bold are manufactured in offshore fabs.
- ・ 太字製品は当社海外工場にて生産しております。

Switching Diodes / スイッチングダイオード

Small-Signal Switching Diodes and Multiple Switching Diodes /
小信号スイッチングダイオード, 複合スイッチングダイオード

V_R (V)	I_o (mA)	t_{rr} (ns)	CST2  (mm)	SOD-923  (mm)	ESC  (mm)	USC  (mm)	CST3  (mm)	VESM  (mm)	SSM  (mm)	USM (SC-70)  (mm)	S-MINI (SC-59)  (mm)	USQ  (mm)		
30	100	—									1SS307 			
80	100	—			1SS307E * 					1SS412 	1SS379 			
80	100	1.6 Typ.							1SS360 	1SS300 	1SS181 			
80	100	1.6 Typ.					1SS361CT 	1SS361FV 	1SS361 	1SS301 	1SS184 			
80	100 (80)	1.6 Typ.						1SS362FV 	(1SS362) 	1SS302A * 	1SS226 			
80	100 (80)	1.6 Typ.	1SS387CT 		1SS387 	1SS352 						1SS193 	1SS382 	
				1SS427 									1SS196 	
													1SS187 	
													1SS190 	
80	100	1.6 Typ.												
80	215	4.0 Max												
100	215	4.0 Max								BAV99W * 				
100	250	3.0 Max			BAS516 * 	BAS316 * 								
200	100	10 (30) Typ.				1SS403 				1SS370 	1SS250 			
400	100	500 (1500) Typ.								1SS397 				
400	100	500 Typ.									1SS398 			

- The I_o ratings enclosed in parentheses are for those devices whose part numbers are enclosed in parentheses.
- The internal connection diagrams only show the general configurations of the circuits.
- ()内の品種は I_o の定格が異なります。
- 内部接続図はイメージ図です。

SMQ (SC-61)	ESV	USV	SMV (SC-74A)	ES6	US6	SM6 (SC-74)	SOT23	Remarks
 (mm)	 (mm)	 (mm)	 (mm)	 (mm)	 (mm)	 (mm)	 (mm)	
								Low leakage current, Single
								Low leakage current, Series-connected
		HN4D01JU	1SS308	HN1D01FE	HN1D01FU	HN1D01F		High-speed switching, Common anode
								High-speed switching, Common cathode
		HN4D02JU	1SS309	HN1D02FE	HN1D02FU	HN1D02F		High-speed switching, Common cathode
								High-speed switching, Series-connected
					HN1D04FU			High-speed switching, Series-connected
								High-speed switching, Independent diodes
1SS272	HN2D01JE				(HN2D01FU)	(HN2D01F)		High-speed switching, Independent diodes
								High-speed switching, Independent diodes
					(HN2D02FU)			High-speed switching, Independent diodes
								High-speed switching, Independent diodes
								High-speed switching, Independent diodes
								High-speed switching, Independent diodes
					HN1D03FU	HN1D03F		High-speed switching, Common cathode + Common anode
								High-speed switching, Common anode
							TBAW56 *	High-speed switching, Common anode
								Low leakage current, Single
							TBAS16 *	Low leakage current, Series-connected
								High-speed switching, Common cathode
							BAV99 *	High-speed switching, Independent diodes
								High breakdown voltage, Independent diodes
							BAV70 *	High breakdown voltage, Independent diodes
								High breakdown voltage, Series-connected
								High breakdown voltage, Series-connected
(1SS306)								High breakdown voltage, Independent diodes
								High breakdown voltage, Independent diodes
1SS399						HN2D03F		High breakdown voltage, Series-connected
								High breakdown voltage, Series-connected

*: New product / 新製品

Zener Diodes / ツェナーダイオード

Zener Diodes / ツェナーダイオード

Power Dissipation P (W)	0.7	1.0	2.0
Zener Voltage Vz (V) (typ.)	S-FLAT	M-FLAT	M-FLAT
6.2	CRY62		
6.8	CRY68		
8.2	CRY82		
10	CRZ10		
12	CRZ12	CMZB12	CMZ12
13	CRZ13	CMZB13	CMZ13
15	CRZ15	CMZB15	CMZ15
16	CRZ16		CMZ16
18	CRZ18	CMZB18	CMZ18
20	CRZ20	CMZB20	CMZ20
24	CRZ24	CMZB24	CMZ24
27	CRZ27	CMZB27	CMZ27
30	CRZ30	CMZB30	CMZ30
33	CRZ33	CMZB33	CMZ33
36	CRZ36	CMZB36	CMZ36
39	CRZ39	CMZB39	CMZ39
43		CMZB43	CMZ43
47		CMZB47	CMZ47
51		CMZB51	CMZ51
68		CMZB68	
75		CMZB75	
82		CMZB82	

・ The products shown in bold are manufactured in offshore fabs.

・ 太字製品は当社海外工場にて生産しております。

Variable Capacitance Diodes / 可変容量ダイオード

Variable Capacitance Diodes / 可変容量ダイオード

(Diodes for Electronic Tuning) / (電子同調用)

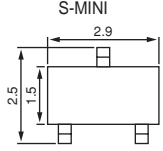
Part Number	Package	V_R (V)	C_T (pF)	V_R (V)	C_T (pF)	V_R (V)	Applications
 S-MINI (mm)							
1SV228		15	28.5 to 32.5	3	11.7 to 13.7	8	FM car radios, portable radios

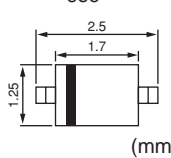
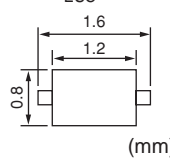
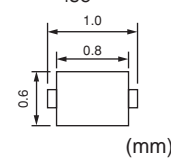
Part Number			V_R (V)	C_T (pF)	V_R (V)	C_T (pF)	V_R (V)	Applications
Package								
USC	ESC	fSC						
								
(mm)	(mm)	(mm)						
1SV324	1SV325		10	44 to 49.5	1	9.2 to 12.2	4	VCXO
	JDV2S36E		10	44 to 49.5	1	5.4 to 7.3	6	VCXO
1SV262	1SV282		34	33 to 38	2	2.6 to 3.0	25	CATV tuners
1SV322	1SV323		10	26.5 to 29.5	1	6 to 7.1	4	VCXO
1SV304	1SV305		10	17.3 to 19.3	1	5.3 to 6.6	4	VHF/UHF VCO
1SV270	1SV281		10	15 to 17	1	7.3 to 8.7	4	VHF/UHF VCO
1SV229	1SV279	JDV2S41FS	15	14 to 16	2	5.5 to 6.5	10	VHF/UHF VCO
1SV310	1SV311	JDV2S09FS	10	9.7 to 11.1	1	4.45 to 5.45	4	VHF/UHF VCO
	1SV314	JDV2S10FS	10	7.3 to 8.4	0.5	2.75 to 3.4	2.5	VHF/UHF VCO
1SV277	1SV285	JDV2S07FS	10	4.0 to 4.9	1	1.85 to 2.35	4	VHF/UHF VCO
1SV239	1SV280		15	3.8 to 4.7	2	1.5 to 2.0	10	L Band VCO

Radio-Frequency Switching Diodes / 高周波スイッチ用ダイオード

Radio-Frequency Switching Diodes / 高周波スイッチ用ダイオード

Part Number	Applications	V_R (V)	I_R (Max)		V_F (Max)		C_T (Typ.)		r_s (Typ.)			Package											
			(μ A)	V_R (V)	(V)	I_F (mA)	(pF)	V_R (V)	(Ω)	I_F (mA)	f (MHz)												
1SS314	TV band switch	30	0.1	15	0.85	2	0.7	6	0.5	2	100	USC											
1SS381												ESC											
1SS268												Twin	30	0.1	15	0.85	2	0.8	6	0.6	2	100	S-Mini
1SS269																							S-Mini
1SS312																							USM
1SS313																							USM
1SS364												SSM											
1SV128	Switch, ATT	50	0.1	50	0.95 (Typ.)	50	0.25	50	3	10	100	S-MINI											
JDV2S12CR												S-FLAT											
1SV307												Single	30	0.1	30	1.0	50	0.3	1	1	10	100	USC
1SV271																							USC
1SV308																							ESC
JDV2S04E																							ESC
JDV2S02AFS																							fSC
JDV2S02ACT																							CST2
JDV2S08SC												SC2											
1SV172												Switch, ATT	50	0.1	50	0.95 (Typ.)	50	0.25	50	3	10	100	S-MINI
JDV3C04TU	UFM																						
JDV3C02AU	USM																						
JDV3C13U	USM																						

SEMICONDUCTOR GENERAL CATALOG

東芝半導体製品総覧表

RESTRICTIONS ON PRODUCT USE

- ▶ Toshiba Corporation, and its subsidiaries and affiliates (collectively "TOSHIBA"), reserve the right to make changes to the information in this document, and related hardware, software and systems (collectively "Product") without notice.
- ▶ This document and any information herein may not be reproduced without prior written permission from TOSHIBA. Even with TOSHIBA's written permission, reproduction is permissible only if reproduction is without alteration/omission.
- ▶ Though TOSHIBA works continually to improve Product's quality and reliability, Product can malfunction or fail. Customers are responsible for complying with safety standards and for providing adequate designs and safeguards for their hardware, software and systems which minimize risk and avoid situations in which a malfunction or failure of Product could cause loss of human life, bodily injury or damage to property, including data loss or corruption. Before customers use the Product, create designs including the Product, or incorporate the Product into their own applications, customers must also refer to and comply with (a) the latest versions of all relevant TOSHIBA information, including without limitation, this document, the specifications, the data sheets and application notes for Product and the precautions and conditions set forth in the "TOSHIBA Semiconductor Reliability Handbook" and (b) the instructions for the application with which the Product will be used with or for. Customers are solely responsible for all aspects of their own product design or applications, including but not limited to (a) determining the appropriateness of the use of this Product in such design or applications; (b) evaluating and determining the applicability of any information contained in this document, or in charts, diagrams, programs, algorithms, sample application circuits, or any other referenced documents; and (c) validating all operating parameters for such designs and applications. **TOSHIBA ASSUMES NO LIABILITY FOR CUSTOMERS' PRODUCT DESIGN OR APPLICATIONS.**
- ▶ **PRODUCT IS NEITHER INTENDED NOR WARRANTED FOR USE IN EQUIPMENTS OR SYSTEMS THAT REQUIRE EXTRAORDINARILY HIGH LEVELS OF QUALITY AND/OR RELIABILITY, AND/OR A MALFUNCTION OR FAILURE OF WHICH MAY CAUSE LOSS OF HUMAN LIFE, BODILY INJURY, SERIOUS PROPERTY DAMAGE AND/OR SERIOUS PUBLIC IMPACT ("UNINTENDED USE").** Except for specific applications as expressly stated in this document, Unintended Use includes, without limitation, equipment used in nuclear facilities, equipment used in the aerospace industry, medical equipment, equipment used for automobiles, trains, ships and other transportation, traffic signaling equipment, equipment used to control combustions or explosions, safety devices, elevators and escalators, devices related to electric power, and equipment used in finance-related fields. **IF YOU USE PRODUCT FOR UNINTENDED USE, TOSHIBA ASSUMES NO LIABILITY FOR PRODUCT.** For details, please contact your TOSHIBA sales representative.
- ▶ Do not disassemble, analyze, reverse-engineer, alter, modify, translate or copy Product, whether in whole or in part.
- ▶ Product shall not be used for or incorporated into any products or systems whose manufacture, use, or sale is prohibited under any applicable laws or regulations.
- ▶ The information contained herein is presented only as guidance for Product use. No responsibility is assumed by TOSHIBA for any infringement of patents or any other intellectual property rights of third parties that may result from the use of Product. No license to any intellectual property right is granted by this document, whether express or implied, by estoppel or otherwise.
- ▶ **ABSENT A WRITTEN SIGNED AGREEMENT, EXCEPT AS PROVIDED IN THE RELEVANT TERMS AND CONDITIONS OF SALE FOR PRODUCT, AND TO THE MAXIMUM EXTENT ALLOWABLE BY LAW, TOSHIBA (1) ASSUMES NO LIABILITY WHATSOEVER, INCLUDING WITHOUT LIMITATION, INDIRECT, CONSEQUENTIAL, SPECIAL, OR INCIDENTAL DAMAGES OR LOSS, INCLUDING WITHOUT LIMITATION, LOSS OF PROFITS, LOSS OF OPPORTUNITIES, BUSINESS INTERRUPTION AND LOSS OF DATA, AND (2) DISCLAIMS ANY AND ALL EXPRESS OR IMPLIED WARRANTIES AND CONDITIONS RELATED TO SALE, USE OF PRODUCT, OR INFORMATION, INCLUDING WARRANTIES OR CONDITIONS OF MERCHANTABILITY, FITNESS FOR A PARTICULAR PURPOSE, ACCURACY OF INFORMATION, OR NON-INFRINGEMENT.**
- ▶ Product may include products using GaAs (Gallium Arsenide). GaAs is harmful to humans if consumed or absorbed, whether in the form of dust or vapor. Handle with care and do not break, cut, crush, grind, dissolve chemically or otherwise expose GaAs in Product.
- ▶ Do not use or otherwise make available Product or related software or technology for any military purposes, including without limitation, for the design, development, use, stockpiling or manufacturing of nuclear, chemical, or biological weapons or missile technology products (mass destruction weapons). Product and related software and technology may be controlled under the applicable export laws and regulations including, without limitation, the Japanese Foreign Exchange and Foreign Trade Law and the U.S. Export Administration Regulations. Export and re-export of Product or related software or technology are strictly prohibited except in compliance with all applicable export laws and regulations.
- ▶ Product may include products subject to foreign exchange and foreign trade control laws.
- ▶ Please contact your TOSHIBA sales representative for details as to environmental matters such as the RoHS compatibility of Product. Please use Product in compliance with all applicable laws and regulations that regulate the inclusion or use of controlled substances, including without limitation, the EU RoHS Directive. **TOSHIBA ASSUMES NO LIABILITY FOR DAMAGES OR LOSSES OCCURRING AS A RESULT OF NONCOMPLIANCE WITH APPLICABLE LAWS AND REGULATIONS.**

In addition to the above, the following are applicable only to development tools.

- ▶ Though TOSHIBA works continually to improve Product's quality and reliability, Product can malfunction or fail. Use the Product in a way which minimizes risk and avoid situations in which a malfunction or failure of Product could cause loss of human life, bodily injury or damage to property, including data loss or corruption. For using the Product, customers must also refer to and comply with the latest versions of all relevant TOSHIBA information, including without limitation, this document, the instruction manual, the specifications, the data sheets for Product.
- ▶ Product is provided solely for the purpose of performing the functional evaluation of a semiconductor product. Please do not use Product for any other purpose, including without limitation, evaluation in high or low temperature or humidity, and verification of reliability.
- ▶ Do not incorporate Product into your products or system. Products are for your own use and not for sale, lease or other transfer.

製品取り扱い上のお願い

- ▶ 本資料に掲載されているハードウェア、ソフトウェアおよびシステム(以下、本製品という)に関する情報等、本資料の掲載内容は、技術の進歩などにより予告なしに変更されることがあります。
- ▶ 文書による当社の事前の承諾なしに本資料の転載複製を禁じます。また、文書による当社の事前の承諾を得て本資料を転載複製する場合でも、記載内容に一切変更を加えたり、削除したりしないでください。
- ▶ 当社は品質、信頼性の向上に努めていますが、半導体・ストレージ製品は一般に誤作動または故障する場合があります。本製品をご使用頂く場合は、本製品の誤作動や故障により生命・身体・財産が侵害されることのないよう、お客様の責任において、お客様のハードウェア・ソフトウェア・システムに必要な安全設計を行うことをお願いします。なお、設計および使用に際しては、本製品に関する最新の情報(本資料、仕様書、データシート、アプリケーションノート、半導体信頼性ハンドブックなど)および本製品が使用される機器の取扱説明書、操作説明書などをご確認の上、これに従ってください。また、上記資料などに記載の製品データ、図、表などに示す技術的な内容、プログラム、アルゴリズムその他応用回路例などの情報を使用する場合は、お客様の製品単独およびシステム全体で十分に評価し、お客様の責任において適用可否を判断してください。
- ▶ 本製品は、特別に高い品質・信頼性が要求され、またはその故障や誤作動が生命・身体に危害を及ぼす恐れ、膨大な財産損害を引き起こす恐れ、もしくは社会に深刻な影響を及ぼす恐れのある機器(以下「特定用途」という)に使用されることは意図されていませんし、保証もされていません。特定用途には原子力関連機器、航空・宇宙機器、医療機器、車載・輸送機器、列車・船舶機器、交通信号機器、燃焼・爆発制御機器、各種安全関連機器、昇降機器、電力機器、金融関連機器などが含まれますが、本資料に個別に記載する用途は除きます。特定用途に使用された場合には、当社は一切の責任を負いません。なお、詳細は当社営業窓口までお問い合わせください。
- ▶ 本製品を分解、解析、リバースエンジニアリング、改造、改変、翻案、複製等しないでください。
- ▶ 本製品を、国内外の法令、規則及び命令により、製造、使用、販売を禁止されている製品に使用することはできません。
- ▶ 本資料に掲載してある技術情報は、製品の代表的動作・応用を説明するためのもので、その使用に際して当社及び第三者の知的財産権その他の権利に対する保証または実施権の許諾を行うものではありません。
- ▶ 別途、書面による契約またはお客様と当社が合意した仕様書がない限り、当社は、本製品および技術情報に関して、明示的にも黙示的にも一切の保証(機能動作の保証、商品性の保証、特定目的への有効の保証、情報の正確性の保証、第三者の権利の非侵害保証を含むがこれに限らない。)をしておりません。
- ▶ 本製品にはGaAs(ガリウムヒ素)が使われているものがあります。その粉末や蒸気等は人体に対し有害ですので、破壊、切断、粉砕や化学的な分解はしないでください。
- ▶ 本製品、または本資料に掲載されている技術情報を、大量破壊兵器の開発等の目的、軍事利用の目的、あるいはその他軍事事務の目的で使用しないでください。また、輸出に際しては、「外国為替及び外国貿易法」、「米国輸出管理規則」等、適用ある輸出関連法令を遵守し、それらの定めるところにより必要な手続を行ってください。
- ▶ 本製品には、外国為替及び外国貿易法により、輸出または海外への提供が規制されているものがあります。
- ▶ 本製品のRoHS適合性など、詳細につきましては製品個別に必ず当社営業窓口までお問い合わせください。本製品のご使用に際しては、特定の物質の含有・使用を規制するRoHS指令等、適用ある環境関連法令を十分調査の上、かかる法令に適合するようご使用ください。お客様がかかる法令を遵守しないことにより生じた損害に関して、当社は一切の責任を負いかねます。

上記に加えて、以下は開発ツールのみ適用されます。

- ▶ 当社は品質、信頼性の向上に努めていますが、本製品は誤作動または故障する場合があります。本製品をご使用頂く場合は、本製品の誤作動や故障により生命・身体・財産が侵害されることのないようご使用ください。本製品をご使用頂く場合は、本製品に関する最新の情報(本資料、取扱説明書、仕様書、データシートなど)をご確認の上、これに従ってください。
- ▶ 本製品は、半導体製品の機能評価に使用されることを意図しています。機能評価以外の目的(温度・湿度特性評価、信頼性評価など)には使用しないでください。
- ▶ 本製品をお客様の製品に組み込まないでください。また、本製品を販売、譲渡、貸与等しないでください。

【お問い合わせ先】

TOSHIBA

TOSHIBA CORPORATION Storage & Electronic Devices Solutions Company

株式会社 東芝 ストレージ&デバイスソリューション社

https://toshiba.semicon-storage.com/

©2017 TOSHIBA CORPORATION