

LOC	QTY	REV	DATE	OWN	APVD
CM	53				

REVISIONS					
REV	DESCRIPTION	DATE	OWN	APVD	
C	REV & REDWN PER EC OL30-0214-97	10-20-97	KW	RS	

AMP LOGO AND CIRCUIT NUMBERS LOCATED APPROXIMATELY AS SHOWN.

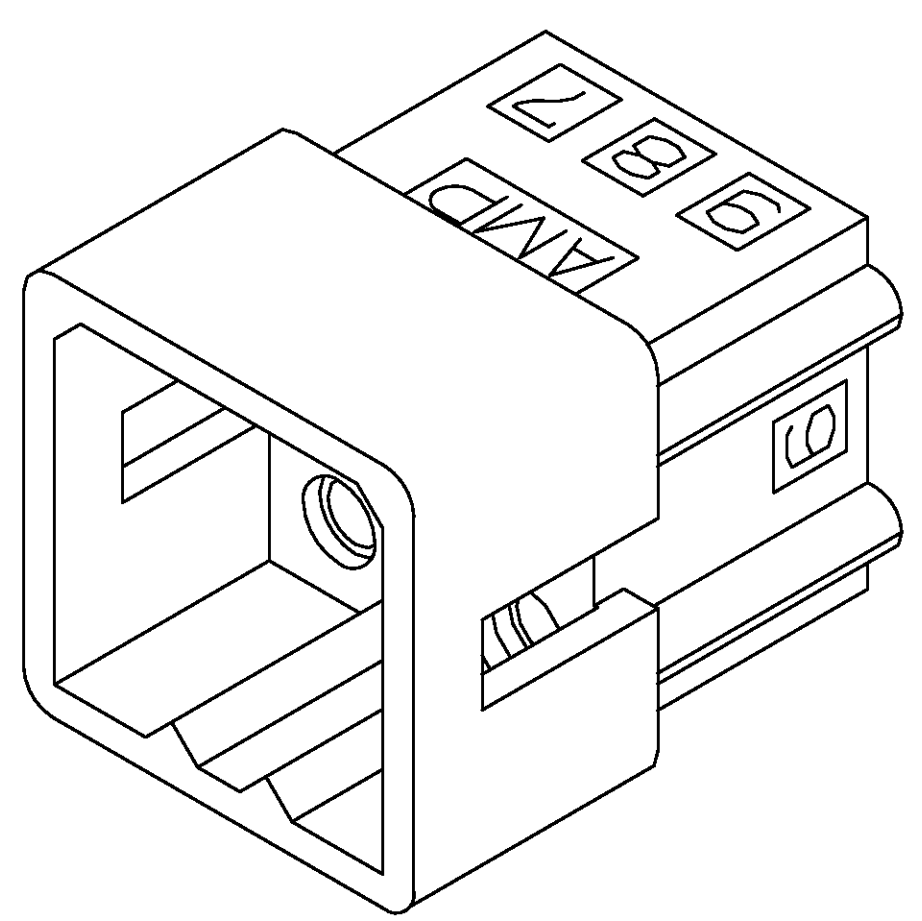
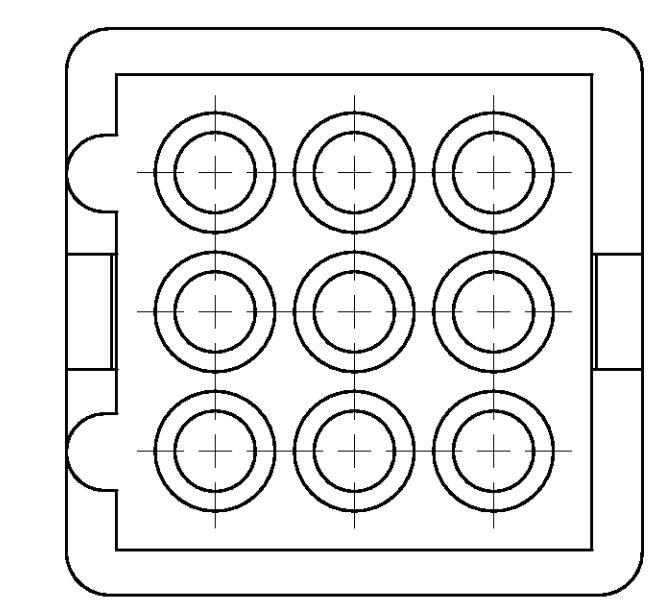
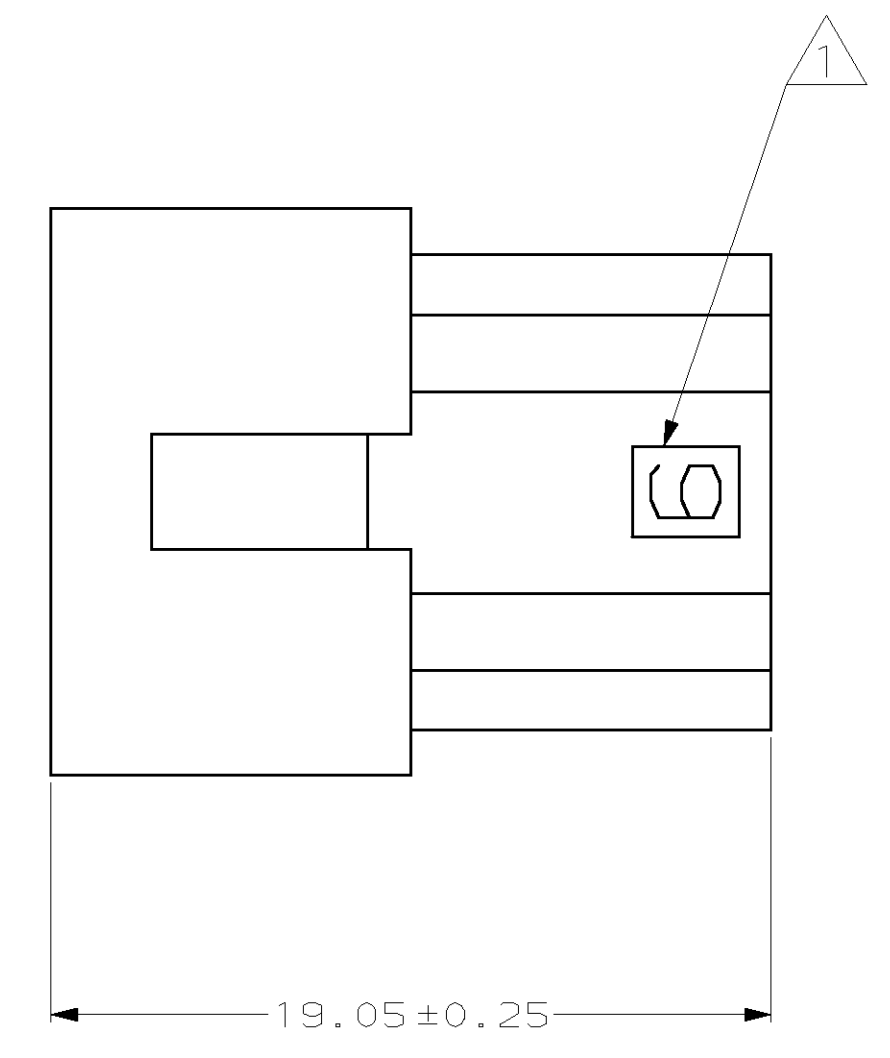
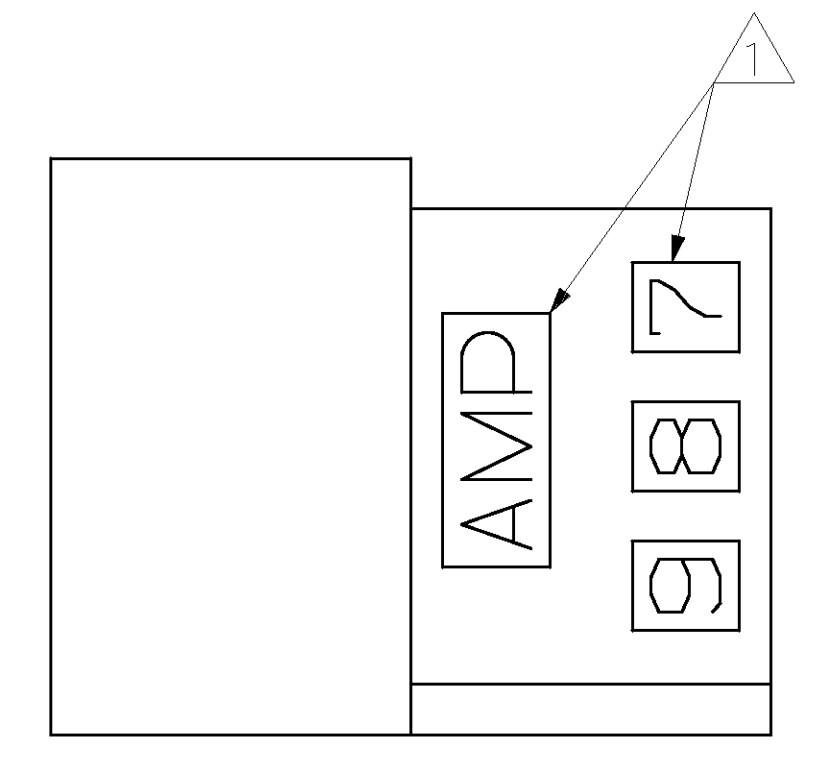
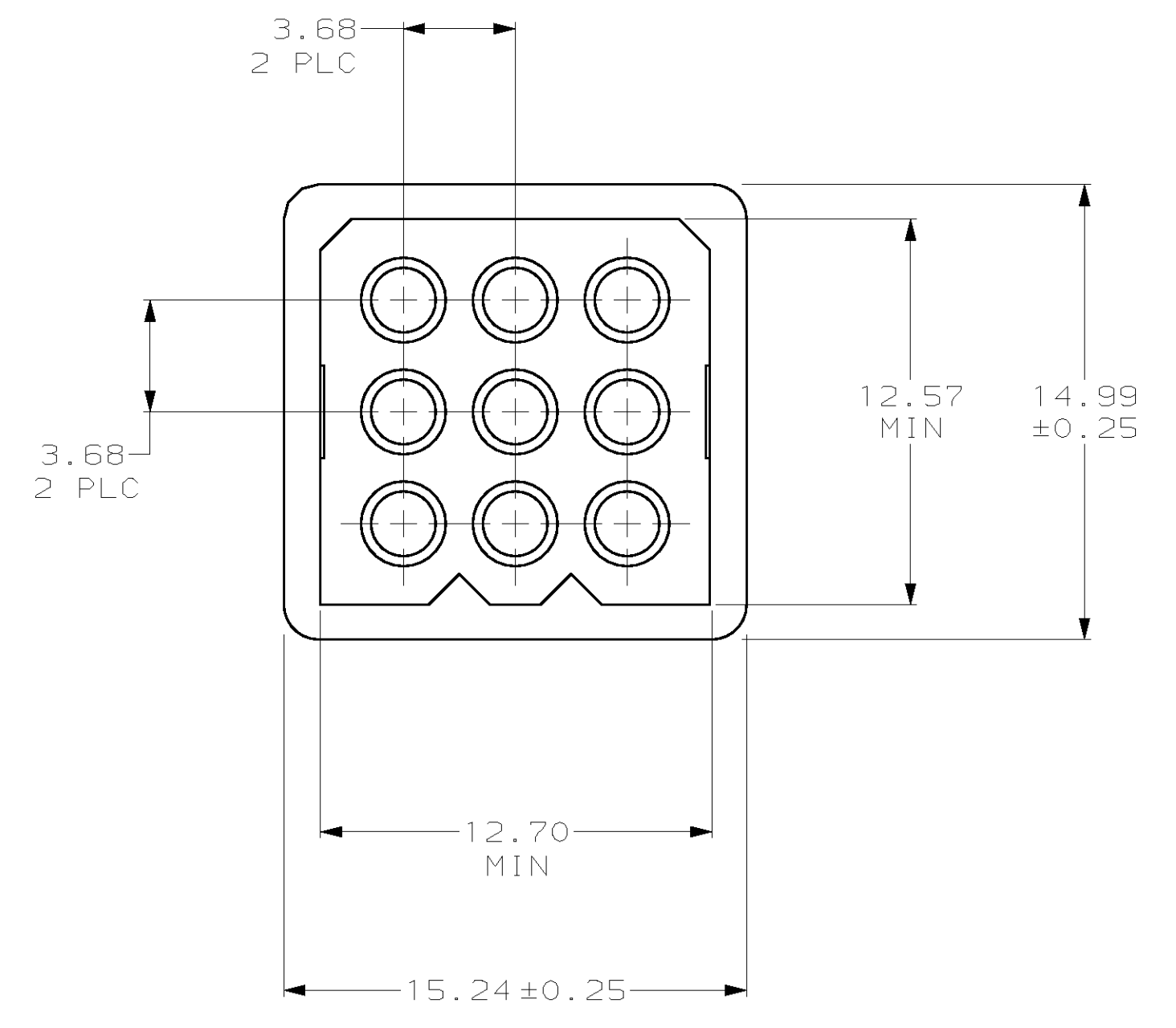
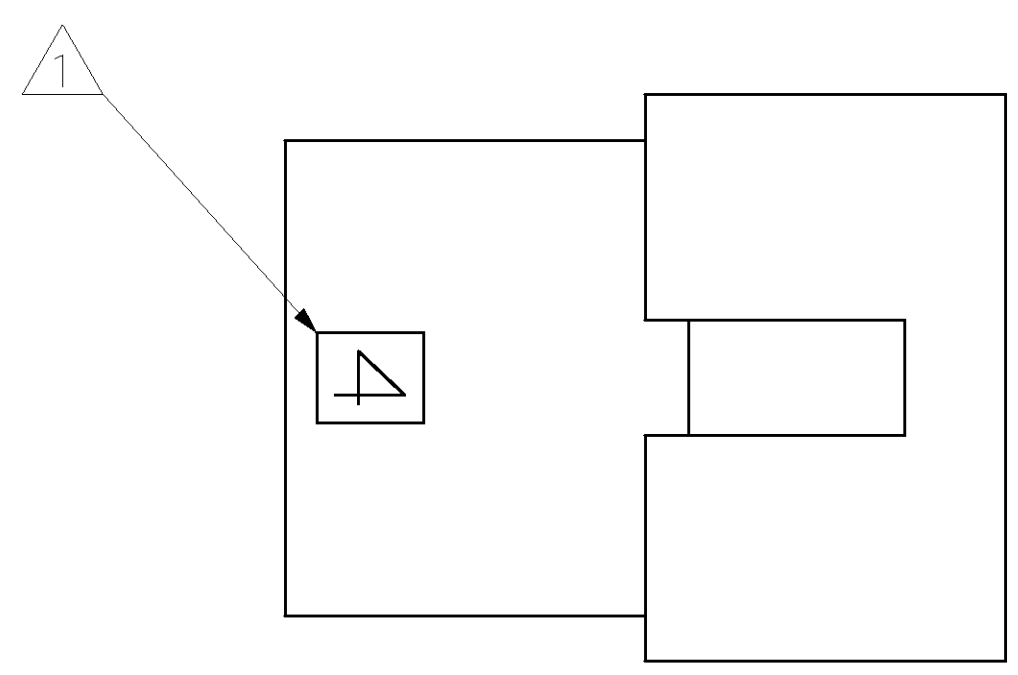

3-DIMENSIONAL MODEL NTS

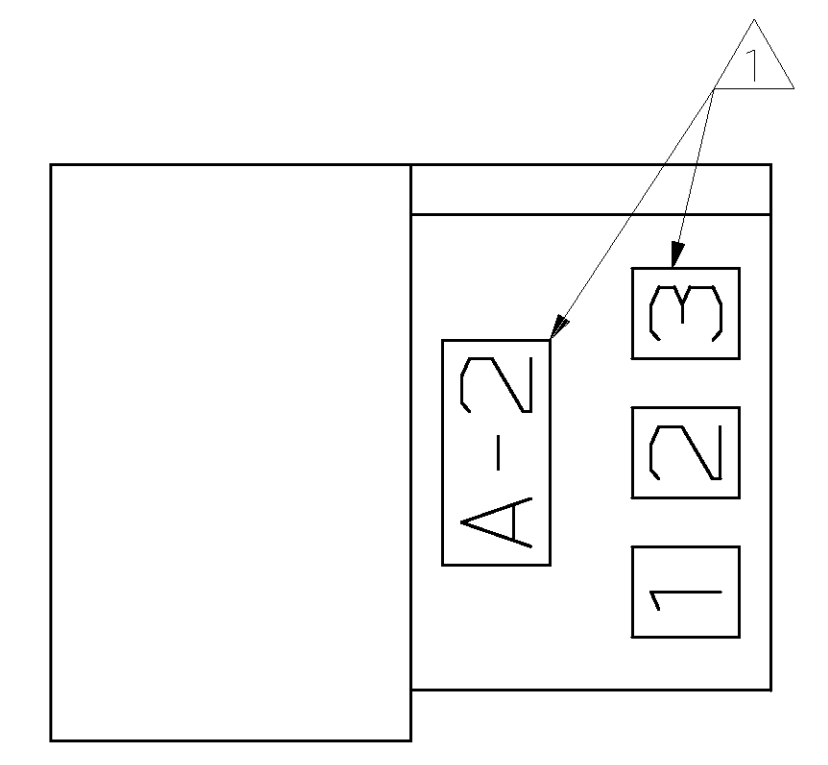

MM	IN	MM	IN
12.57	.495	-	-
3.68	.145	19.05	.750
1.58	.062	15.24	.600
0.25	.010	14.99	.590
0.13	.005	12.70	.500

CONVERSION TABLE

METRIC

THIS DRAWING IS A CONTROLLED DOCUMENT.

DIMENSIONS:	TOLERANCES UNLESS OTHERWISE SPECIFIED:	OWN: K. WHITAKER	10-20-97
mm	9 PLC ±-	CHK: R. SWING	10-20-97
	1 PLC ±-.13	APVD: J. CORLE	10-20-97
	2 PLC ±-.13	PRODUCT SPEC:	
	3 PLC ±-	APPLICATION SPEC:	
	4 PLC ±-	HEIGHT:	
MATERIAL: NYLON, JL 94V-2, NATURAL	FINISH: -	SIZE: A1	SCALE CODE: C

AMP Incorporated
 Harrisburg, PA 17105-3608

PLUG, 9 CIRCUIT, .062 PIN AND SOCKET

770428-1
 PART NUMBER

CUSTOMER DRAWING SCALE: 5:1 SHEET 1 OF 1 REV C