

### FEATURES

- Single 1.8 V supply operation
- SNR: 49.3 dBFS at 200 MHz input at 250 MSPS
- SFDR: 65 dBc at 200 MHz input at 250 MSPS
- Low power: 314 mW at 250 MSPS
- On-chip reference and track-and-hold
- 1.2 V p-p analog input range for each channel
- Differential input with 500 MHz bandwidth
- LVDS-compliant digital output
- DNL:  $\pm 0.2$  LSB
- Serial port control options
  - Offset binary, Gray code, or twos complement data format
  - Optional clock duty cycle stabilizer
  - Built-in selectable digital test pattern generation
- Pin-programmable power-down function
- Available in 48-lead LFCSP

### APPLICATIONS

- Communications
- Diversity radio systems
- I/Q demodulation systems
- Battery-powered instruments
- Handheld scope meters
- Low cost digital oscilloscopes
- OTS: video over fiber

### GENERAL DESCRIPTION

The AD9284 is a dual 8-bit, monolithic sampling, analog-to-digital converter (ADC) that supports simultaneous operation and is optimized for low cost, low power, and ease of use. Each ADC operates at up to a 250 MSPS conversion rate with outstanding dynamic performance.

The ADC requires a single 1.8 V supply and an encode clock for full performance operation. No external reference components are required for many applications. The digital outputs are LVDS compatible.

The AD9284 is available in a Pb-free, 48-lead LFCSP that is specified over the industrial temperature range of  $-40^{\circ}\text{C}$  to  $+85^{\circ}\text{C}$ .

### PRODUCT HIGHLIGHTS

1. Integrated Dual 8-Bit, 250 MSPS ADC.
2. Single 1.8 V Supply Operation with LVDS Outputs.
3. Power-Down Option Controlled via a Pin-Programmable Setting.

### FUNCTIONAL BLOCK DIAGRAM

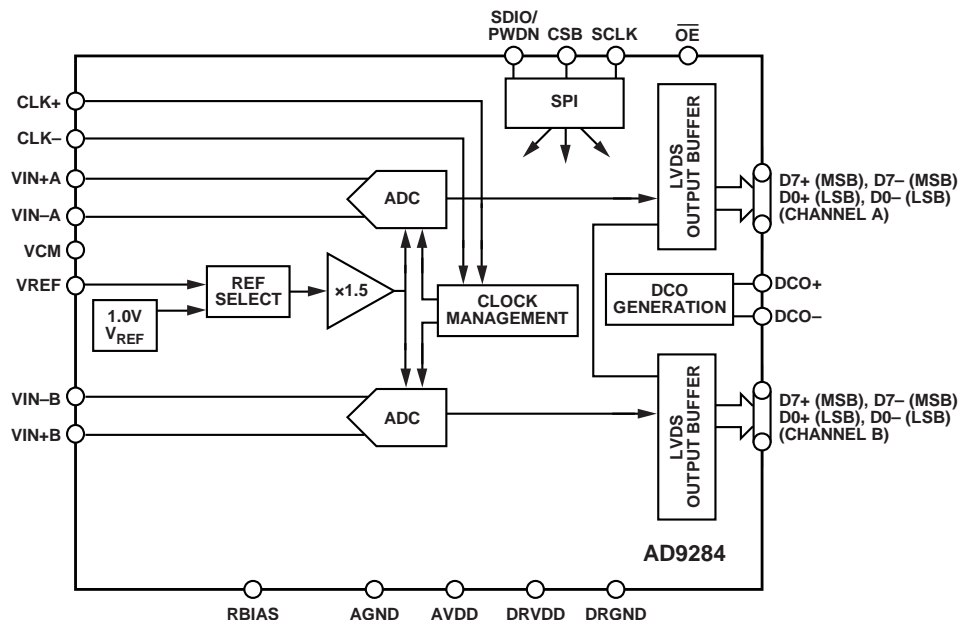

Figure 1.

Rev. A

[Document Feedback](#)

Information furnished by Analog Devices is believed to be accurate and reliable. However, no responsibility is assumed by Analog Devices for its use, nor for any infringements of patents or other rights of third parties that may result from its use. Specifications subject to change without notice. No license is granted by implication or otherwise under any patent or patent rights of Analog Devices. Trademarks and registered trademarks are the property of their respective owners.

# AD9284\* PRODUCT PAGE QUICK LINKS

Last Content Update: 02/23/2017

---

## COMPARABLE PARTS

View a parametric search of comparable parts.

## EVALUATION KITS

- AD9284 Evaluation Board

## DOCUMENTATION

### Application Notes

- AN-1142: Techniques for High Speed ADC PCB Layout
- AN-282: Fundamentals of Sampled Data Systems
- AN-345: Grounding for Low-and-High-Frequency Circuits
- AN-501: Aperture Uncertainty and ADC System Performance
- AN-586: LVDS Outputs for High Speed A/D Converters
- AN-715: A First Approach to IBIS Models: What They Are and How They Are Generated
- AN-737: How ADIsimADC Models an ADC
- AN-742: Frequency Domain Response of Switched-Capacitor ADCs
- AN-756: Sampled Systems and the Effects of Clock Phase Noise and Jitter
- AN-827: A Resonant Approach to Interfacing Amplifiers to Switched-Capacitor ADCs
- AN-835: Understanding High Speed ADC Testing and Evaluation
- AN-851: A WiMax Double Downconversion IF Sampling Receiver Design
- AN-878: High Speed ADC SPI Control Software
- AN-905: Visual Analog Converter Evaluation Tool Version 1.0 User Manual
- AN-935: Designing an ADC Transformer-Coupled Front End

### Data Sheet

- AD9284: 8-Bit, 250 MSPS, 1.8 V Dual Analog-to-Digital Converter (ADC) Data Sheet

### User Guides

- UG-178: Evaluating the AD9284 Analog-to-Digital Converter

## TOOLS AND SIMULATIONS

- Visual Analog
- AD9284 IBIS Model

## REFERENCE MATERIALS

### Technical Articles

- MS-2210: Designing Power Supplies for High Speed ADC

## DESIGN RESOURCES

- AD9284 Material Declaration
- PCN-PDN Information
- Quality And Reliability
- Symbols and Footprints

## DISCUSSIONS

View all AD9284 EngineerZone Discussions.

## SAMPLE AND BUY

Visit the product page to see pricing options.

## TECHNICAL SUPPORT

Submit a technical question or find your regional support number.

## DOCUMENT FEEDBACK

Submit feedback for this data sheet.

## TABLE OF CONTENTS

Features .....	1	Voltage Reference .....	13
Applications.....	1	RBIAS.....	13
General Description .....	1	Clock Input Considerations.....	14
Product Highlights .....	1	Digital Outputs .....	14
Functional Block Diagram .....	1	Built-In Self-Test (BIST) and Output Test .....	15
Revision History .....	2	Built-In Self-Test (BIST).....	15
Specifications.....	3	Output Test Modes.....	15
DC Specifications .....	3	Serial Port Interface (SPI).....	16
AC Specifications.....	4	Configuration Using the SPI.....	16
Digital Specifications .....	5	Hardware Interface.....	17
Switching Specifications .....	6	Configuration Without the SPI .....	17
SPI Timing Specifications .....	6	SPI Accessible Features.....	17
Absolute Maximum Ratings.....	7	Memory Map .....	18
Thermal Resistance .....	7	Reading the Memory Map Register Table.....	18
ESD Caution.....	7	Memory Map Register Table.....	19
Pin Configuration and Function Descriptions.....	8	Memory Map Register Descriptions.....	21
Typical Performance Characteristics .....	10	Applications Information .....	22
Equivalent Circuits .....	12	Design Guidelines .....	22
Theory of Operation .....	13	Outline Dimensions .....	23
ADC Architecture .....	13	Ordering Guide .....	23
Analog Input Considerations.....	13		

## REVISION HISTORY

### 6/13—Rev. 0 to Rev. A

Changes to Clock Input Parameters, Table 4.....6

### 1/11—Revision 0: Initial Version

## SPECIFICATIONS

### DC SPECIFICATIONS

AVDD = 1.8 V, DRVDD = 1.8 V, 1.0 V internal ADC reference, unless otherwise noted.

Table 1.

Parameter <sup>1</sup>	Temperature	Min	Typ	Max	Unit
RESOLUTION	Full	8			Bits
DC ACCURACY					
Differential Nonlinearity	Full		±0.2	±0.4	LSB
Integral Nonlinearity	Full		±0.1	±0.3	LSB
No Missing Codes	Full		Guaranteed		
Offset Error	Full	0	±0.4	±2.1	% FS
Gain Error	Full	0	±2.5	±2.8	% FS
MATCHING CHARACTERISTICS					
Offset Error	Full	0	±0.5	±2.6	% FS
Gain Error	Full	0	±0.1	±0.7	% FS
TEMPERATURE DRIFT					
Offset Error	Full		±2		ppm/°C
Gain Error	Full		±20		ppm/°C
ANALOG INPUT					
Input Span	Full		1.2		V p-p
Input Common-Mode Voltage	Full		1.4		V
Input Resistance (Differential)	Full		16		kΩ
Input Capacitance (Differential)	Full		250		fF
Full Power Bandwidth	Full		700		MHz
VOLTAGE REFERENCE					
Internal Reference	Full	0.97	0.98	0.99	V
Input Resistance	Full		3		kΩ
POWER SUPPLIES					
Supply Voltage					
AVDD	Full	1.7	1.8	1.9	V
DRVDD	Full	1.7	1.8	1.9	V
Supply Current					
I <sub>AVDD</sub>	Full		124	128	mA
I <sub>DRVDD</sub>	Full		51	54	mA
POWER CONSUMPTION					
Sine Wave Input <sup>2</sup>	Full		314	330	mW
Power-Down Power	Full		0.3	1.7	mW

<sup>1</sup> See the AN-835 Application Note, *Understanding High Speed ADC Testing and Evaluation*, for a complete set of definitions and an explanation of how these tests were completed.

<sup>2</sup> Measured with a low frequency, full-scale sine wave, with approximately 5 pF loading on each output bit.

**AC SPECIFICATIONS**

AVDD = 1.8 V, DRVDD = 1.8 V, 1.0 V internal ADC reference, maximum sample rate, VIN = -1.0 dBFS differential input, unless otherwise noted.

**Table 2.**

Parameter	Temperature	Min	Typ	Max	Unit
SIGNAL-TO-NOISE RATIO (SNR)					
$f_{IN} = 10.3 \text{ MHz}$	25°C		49.3		dBFS
$f_{IN} = 70 \text{ MHz}$	25°C		49.3		dBFS
$f_{IN} = 96.6 \text{ MHz}$	Full	48.7	49.3		dBFS
$f_{IN} = 220 \text{ MHz}$	25°C		49.3		dBFS
SIGNAL-TO-NOISE-AND-DISTORTION (SINAD)					
$f_{IN} = 10.3 \text{ MHz}$	25°C		49.2		dBFS
$f_{IN} = 70 \text{ MHz}$	25°C		49.2		dBFS
$f_{IN} = 96.6 \text{ MHz}$	Full	48.5	49.2		dBFS
$f_{IN} = 220 \text{ MHz}$	25°C		49.2		dBFS
EFFECTIVE NUMBER OF BITS (ENOB)					
$f_{IN} = 10.3 \text{ MHz}$	25°C		7.9		Bits
$f_{IN} = 70 \text{ MHz}$	25°C		7.9		Bits
$f_{IN} = 96.6 \text{ MHz}$	Full	7.8	7.9		Bits
$f_{IN} = 220 \text{ MHz}$	25°C		7.9		Bits
WORST SECOND OR THIRD HARMONIC					
$f_{IN} = 10.3 \text{ MHz}$	25°C		-70		dBc
$f_{IN} = 70 \text{ MHz}$	25°C		-70		dBc
$f_{IN} = 96.6 \text{ MHz}$	Full		-70	-61	dBc
$f_{IN} = 220 \text{ MHz}$	25°C		-65		dBc
SPURIOUS-FREE DYNAMIC RANGE (SFDR)					
$f_{IN} = 10.3 \text{ MHz}$	25°C		70		dBc
$f_{IN} = 70 \text{ MHz}$	25°C		70		dBc
$f_{IN} = 96.6 \text{ MHz}$	Full	61	69		dBc
$f_{IN} = 220 \text{ MHz}$	25°C		65		dBc
WORST OTHER HARMONIC OR SPUR					
$f_{IN} = 10.3 \text{ MHz}$	25°C		-71		dBc
$f_{IN} = 70 \text{ MHz}$	25°C		-71		dBc
$f_{IN} = 96.6 \text{ MHz}$	Full		-70	-64	dBc
$f_{IN} = 220 \text{ MHz}$	25°C		-67		dBc
CROSSTALK	Full		-80		dBc

**DIGITAL SPECIFICATIONS**

AVDD = 1.8 V, DRVDD = 1.8 V, 1.0 V internal ADC reference, full temperature, unless otherwise noted.

**Table 3.**

Parameter <sup>1</sup>	Temperature	Min	Typ	Max	Unit
<b>CLOCK INPUTS (CLK+, CLK–)</b>					
Logic Compliance			LVDS/PECL		
Internal Common-Mode Bias	Full		1.2		V
Differential Input Voltage <sup>2</sup>	Full	0.2		6	V p-p
Input Voltage Range	Full	AVDD – 0.3		AVDD + 1.6	V
High Level Input Voltage	Full	1.2		3.6	V
Low Level Input Voltage	Full	0		0.8	V
High Level Input Current	Full	–10		+10	μA
Low Level Input Current	Full	–10		+10	μA
Input Resistance (Differential)	25°C		20		kΩ
Input Capacitance	25°C		4		pF
<b>LOGIC INPUTS</b>					
<b>CSB</b>					
High Level Input Voltage	Full	1.2		DRVDD + 0.3	V
Low Level Input Voltage	Full	0		0.8	V
High Level Input Current	Full	–5	–0.4	+5	μA
Low Level Input Current	Full	–80	–63	–50	μA
Input Resistance	25°C		30		kΩ
Input Capacitance	25°C		2		pF
<b>SCLK, SDIO/PWDN, <math>\overline{OE}</math></b>					
High Level Input Voltage	Full	1.2		DRVDD + 0.3	V
Low Level Input Voltage	Full	0		0.8	V
High Level Input Current	Full	50	57	70	μA
Low Level Input Current	Full	–5	–0.4	+5	μA
Input Resistance	25°C		30		kΩ
Input Capacitance	25°C		2		pF
<b>DIGITAL OUTPUTS (D7+, D7– to D0+, D0–), LVDS</b>					
DRVDD = 1.8 V					
Differential Output Voltage ( $V_{OD}$ )	Full	290	345	400	mV
Output Offset Voltage ( $V_{OS}$ )	Full	1.15	1.25	1.35	V
Output Coding (Default)			Offset binary		

<sup>1</sup> See the AN-835 Application Note, *Understanding High Speed ADC Testing and Evaluation*, for a complete set of definitions and an explanation of how these tests were completed.

<sup>2</sup> Specified for LVDS and LVPECL only.

**SWITCHING SPECIFICATIONS**

AVDD = 1.8 V, DRVDD = 1.8 V, maximum sample rate, -1.0 dBFS differential input, 1.0 V internal reference, unless otherwise noted.

Table 4.

Parameter	Temperature	Min	Typ	Max	Unit
<b>CLOCK INPUT PARAMETERS</b>					
Input Clock Rate	Full	30		250	MHz
CLK Period ( $t_{CLK}$ )	Full	4			ns
CLK Pulse Width High ( $t_{CH}$ )	Full		2		ns
<b>DATA OUTPUT PARAMETERS</b>					
Data Propagation Delay ( $t_{PD}$ )			3.7		ns
DCO Propagation Delay ( $t_{DCO}$ )	Full		3.7		ns
DCO to Data Skew ( $t_{SKEW}$ )	Full	-280	-60	+100	ps
Pipeline Delay (Latency)	Full		10.5		Cycles
Aperture Delay ( $t_A$ )	Full		1.0		ns
Aperture Uncertainty (Jitter, $t_j$ )	Full		0.1		ps rms
Wake-Up Time <sup>1</sup>	Full		500		$\mu$ s
OUT-OF-RANGE RECOVERY TIME	Full		2		Cycles

<sup>1</sup> Wake-up time is dependent on the value of the decoupling capacitors.

**SPI TIMING SPECIFICATIONS**

Table 5.

Parameter	Description	Min	Typ	Max	Unit
<b>SPI TIMING REQUIREMENTS</b>					
$t_{DS}$	Setup time between the data and the rising edge of SCLK	2			ns
$t_{DH}$	Hold time between the data and the rising edge of SCLK	2			ns
$t_{CLK}$	Period of the SCLK	40			ns
$t_S$	Setup time between CSB and SCLK	2			ns
$t_H$	Hold time between CSB and SCLK	2			ns
$t_{HIGH}$	SCLK pulse width high	10			ns
$t_{LOW}$	SCLK pulse width low	10			ns
$t_{EN\_SDIO}$	Time required for the SDIO pin to switch from an input to an output relative to the SCLK falling edge	10			ns
$t_{DIS\_SDIO}$	Time required for the SDIO pin to switch from an output to an input relative to the SCLK rising edge	10			ns

**Timing Diagram**

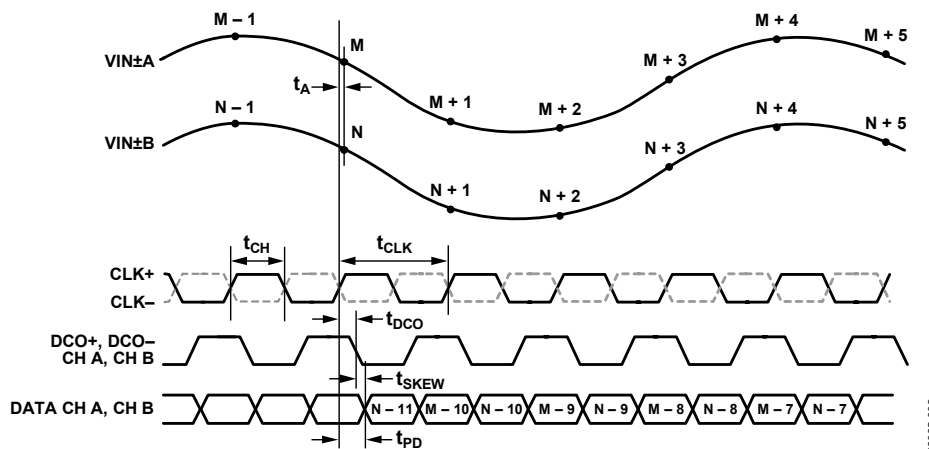

Figure 2. Output Data Timing

## ABSOLUTE MAXIMUM RATINGS

Table 6.

Parameter	Rating
Electrical	
AVDD to AGND	−0.3 V to +2.0 V
DRVDD to DRGND	−0.3 V to +2.0 V
AGND to DRGND	−0.3 V to +0.3 V
AVDD to DRVDD	−2.0 V to +2.0 V
D0+/D0− through D7+/D7− to DRGND	−0.3 V to DRVDD + 0.3 V
DCO+, DCO− to DRGND	−0.3 V to DRVDD + 0.3 V
CLK+, CLK− to AGND	−0.3 V to AVDD + 0.2 V
VIN±A, VIN±B to AGND	−0.3 V to AVDD + 0.2 V
SDIO/PWDN to DRGND	−0.3 V to DRVDD + 0.3 V
CSB to AGND	−0.3 V to DRVDD + 0.3 V
SCLK to AGND	−0.3 V to DRVDD + 0.3 V
Environmental	
Storage Temperature Range	−65°C to +125°C
Operating Temperature Range	−40°C to +85°C
Lead Temperature (Soldering, 10 sec)	300°C
Junction Temperature	150°C

Stresses above those listed under Absolute Maximum Ratings may cause permanent damage to the device. This is a stress rating only; functional operation of the device at these or any other conditions above those indicated in the operational section of this specification is not implied. Exposure to absolute maximum rating conditions for extended periods may affect device reliability.

### THERMAL RESISTANCE

$\theta_{JA}$  is specified for the worst-case conditions, that is, a device soldered in a circuit board for surface-mount packages.

Table 7. Thermal Resistance

Package Type	$\theta_{JA}$	$\theta_{JC}$	Unit
48-Lead LFCSP (CP-48-12)	30.4	2.9	°C/W

### ESD CAUTION



**ESD (electrostatic discharge) sensitive device.** Charged devices and circuit boards can discharge without detection. Although this product features patented or proprietary protection circuitry, damage may occur on devices subjected to high energy ESD. Therefore, proper ESD precautions should be taken to avoid performance degradation or loss of functionality.



## PIN CONFIGURATION AND FUNCTION DESCRIPTIONS

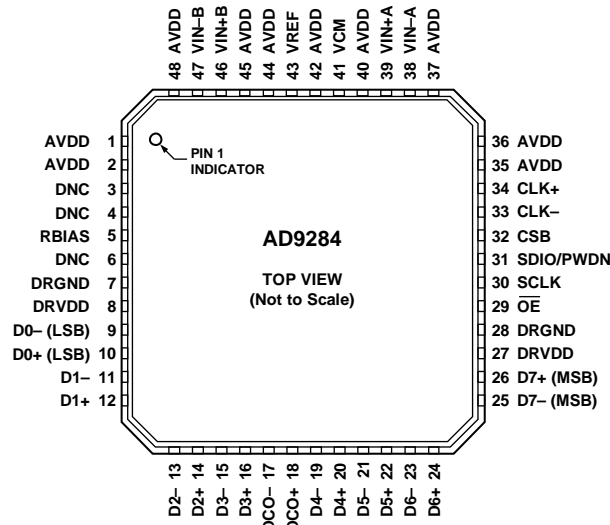

**NOTES**  
 1. DNC = DO NOT CONNECT. DO NOT CONNECT TO THIS PIN.  
 2. THE EXPOSED PADDLE MUST BE SOLDERED TO THE PCB ANALOG GROUND TO ENSURE PROPER FUNCTIONALITY AND HEAT DISSIPATION, NOISE, AND MECHANICAL STRENGTH BENEFITS.

09085-003

Figure 3. Pin Configuration

Table 8. Pin Function Descriptions

Pin No.	Mnemonic	Type	Description
<b>ADC Power Pins</b>			
1, 2, 35, 36, 37, 40, 42, 44, 45, 48	AVDD	Supply	Analog Power Supply (1.8 V Nominal).
8, 27	DRVDD	Supply	Digital Output Driver Supply (1.8 V Nominal).
7, 28	DRGND	Ground	Digital Output Ground.
0	AGND	Ground	Analog Ground. Pin 0 is the exposed thermal pad on the bottom of the package. This is the only ground connection, and it must be soldered to the PCB analog ground to ensure proper functionality and heat dissipation, noise, and mechanical strength benefits.
<b>ADC Analog Pins</b>			
39	VIN+A	Input	Differential Analog Input Pin (+) for Channel A.
38	VIN-A	Input	Differential Analog Input Pin (-) for Channel A.
46	VIN+B	Input	Differential Analog Input Pin (+) for Channel B.
47	VIN-B	Input	Differential Analog Input Pin (-) for Channel B.
43	VREF	Input/output	Voltage Reference Input/Output.
5	RBIAS	Input/output	External Reference Bias Resistor. Connect 10 kΩ from RBIAS to AGND.
41	VCM	Output	Common-Mode Level Bias Output for Analog Inputs.
34	CLK+	Input	ADC Clock Input—True.
33	CLK-	Input	ADC Clock Input—Complement.
<b>Digital Input</b>			
29	OE	Input	Digital Enable (Active Low) to Tristate Output Data Pins.
<b>Digital Outputs</b>			
26	D7+ (MSB)	Output	Channel A/Channel B LVDS Output Data 7—True.
25	D7- (MSB)	Output	Channel A/Channel B LVDS Output Data 7—Complement.
24	D6+	Output	Channel A/Channel B LVDS Output Data 6—True.
23	D6-	Output	Channel A/Channel B LVDS Output Data 6—Complement.
22	D5+	Output	Channel A/Channel B LVDS Output Data 5—True.
21	D5-	Output	Channel A/Channel B LVDS Output Data 5—Complement.
20	D4+	Output	Channel A/Channel B LVDS Output Data 4—True.
19	D4-	Output	Channel A/Channel B LVDS Output Data 4—Complement.

Pin No.	Mnemonic	Type	Description
16	D3+	Output	Channel A/Channel B LVDS Output Data 3—True.
15	D3–	Output	Channel A/Channel B LVDS Output Data 3—Complement.
14	D2+	Output	Channel A/Channel B LVDS Output Data 2—True.
13	D2–	Output	Channel A/Channel B LVDS Output Data 2—Complement.
12	D1+	Output	Channel A/Channel B LVDS Output Data 1—True.
11	D1–	Output	Channel A/Channel B LVDS Output Data 1—Complement.
10	D0+ (LSB)	Output	Channel A/Channel B LVDS Output Data 0—True.
9	D0– (LSB)	Output	Channel A/Channel B LVDS Output Data 0—Complement.
18	DCO+	Output	Channel A/Channel B LVDS Data Clock Output—True.
17	DCO–	Output	Channel A/Channel B LVDS Data Clock Output—Complement.
SPI Control Pins			
30	SCLK	Input	SPI Serial Clock.
31	SDIO/PWDN	Input/output	SPI Serial Data I/O (SDIO)/Power-Down Input in External Mode (PWDN).
32	CSB	Input	SPI Chip Select (Active Low).
Do Not Connect			
3, 4, 6	DNC	N/A	Do Not Connect. Do not connect to this pin.

# TYPICAL PERFORMANCE CHARACTERISTICS

AVDD = 1.8 V, DRVDD = 1.8 V, sample rate = 250 MSPS, DCS enabled, 1.2 V p-p differential input, VIN = -1.0 dBFS, 64k sample, TA = 25°C, unless otherwise noted.

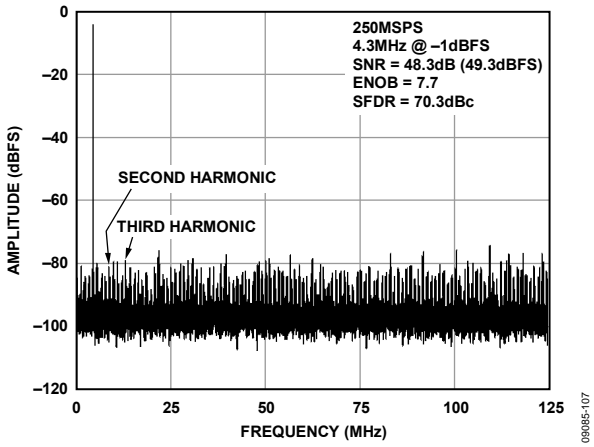

Figure 4. Single-Tone FFT with  $f_{IN} = 4.3$  MHz

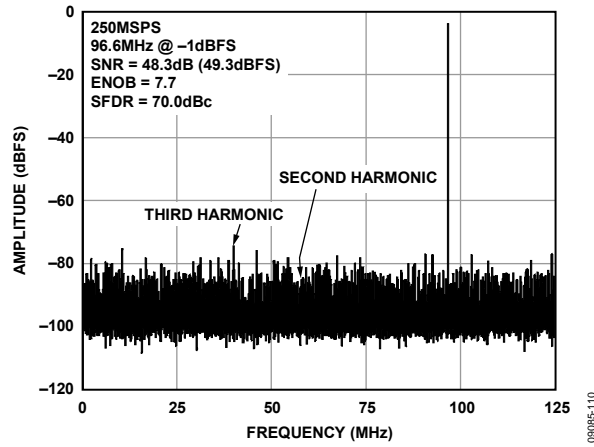

Figure 7. Single-Tone FFT with  $f_{IN} = 96.6$  MHz

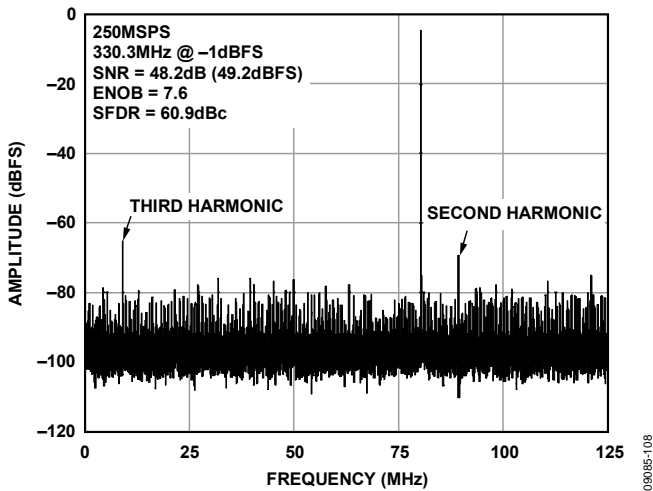

Figure 5. Single-Tone FFT with  $f_{IN} = 220.3$  MHz

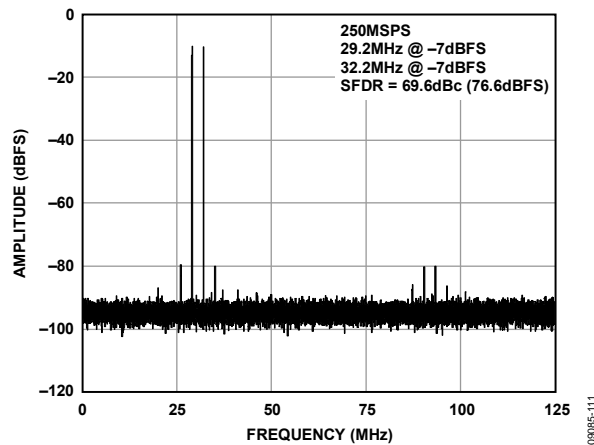

Figure 8. Two-Tone FFT with  $f_{IN1} = 29.1$  MHz and  $f_{IN2} = 32.1$  MHz

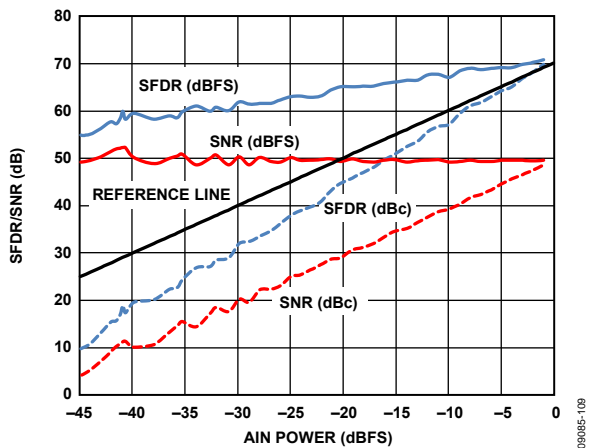

Figure 6. SFDR/SNR vs. Input Amplitude (AIN) with  $f_{IN} = 2.2$  MHz

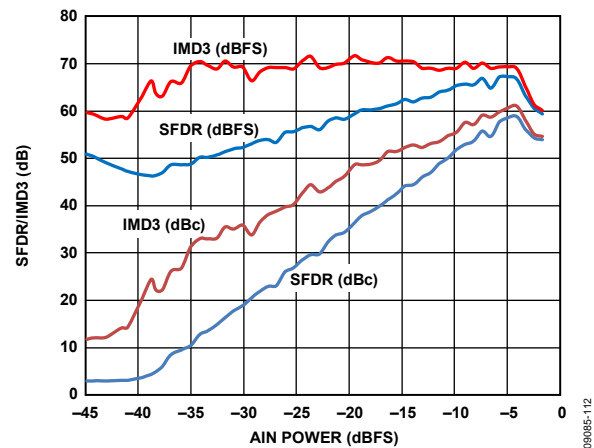

Figure 9. Two-Tone SFDR/IMD3 vs. Input Amplitude (AIN) with  $f_{IN1} = 29.1$  MHz and  $f_{IN2} = 32.1$  MHz

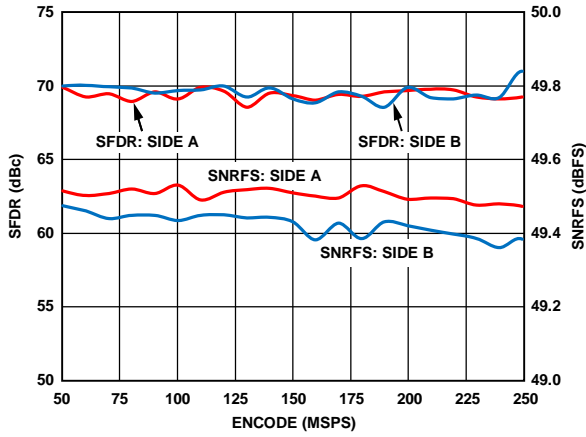

Figure 10. SNRFS/SFDR vs Encode with  $f_{IN} = 2.4$  MHz

09085-113

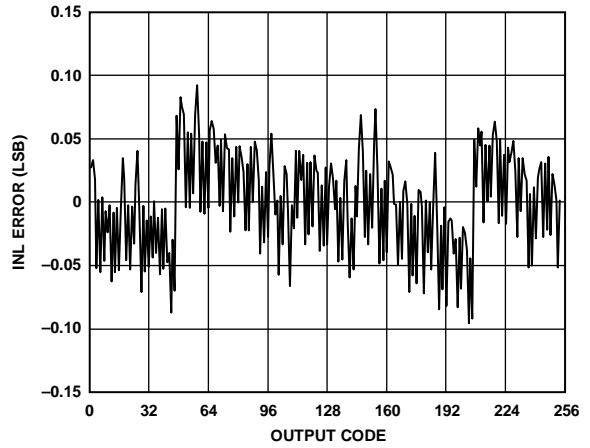

Figure 12. INL Error with  $f_{IN} = 4.3$  MHz

09085-117

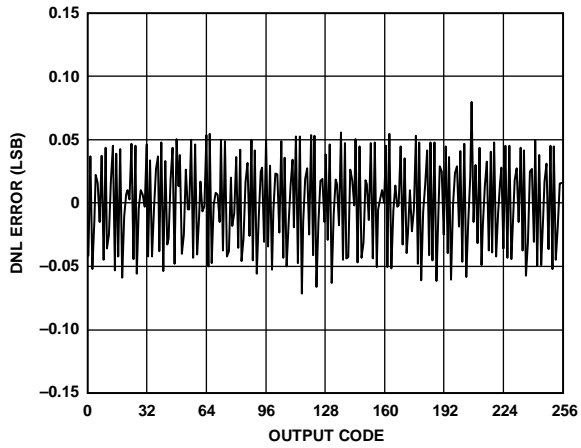

Figure 11. DNL Error with  $f_{IN} = 4.3$  MHz

09085-115

EQUIVALENT CIRCUITS

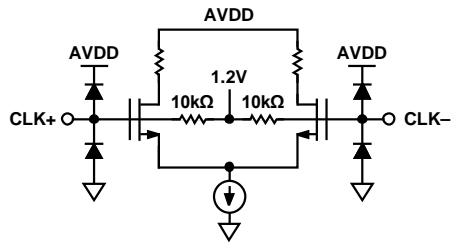

Figure 13. Clock Inputs

09085-019

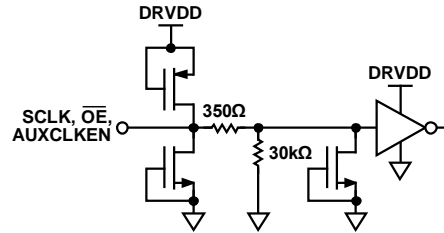

Figure 16. SCLK,  $\overline{OE}$

09085-022

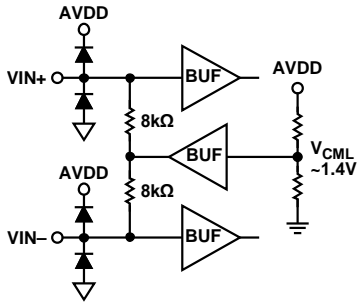

Figure 14. Analog Inputs ( $V_{CML} \approx 1.4V$ )

09085-020

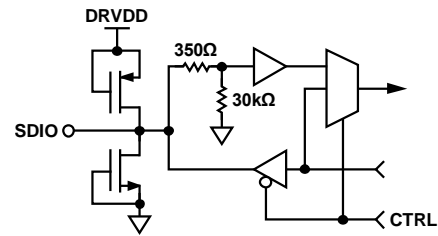

Figure 17. SDIO

09085-023

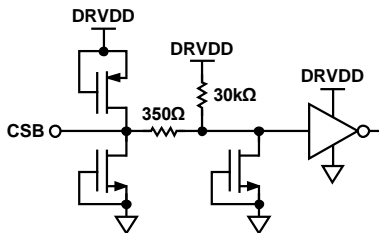

Figure 15. CSB

09085-021

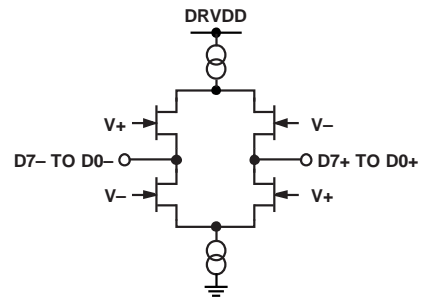

Figure 18. LVDS Output Driver

09085-024

## THEORY OF OPERATION

The AD9284 is a pipeline-type converter. The input buffers are differential, and both sets of inputs are internally biased. This allows the use of ac or dc input modes. A sample-and-hold amplifier is incorporated into the first stage of the multistage pipeline converter core. The output staging block aligns the data, carries out error correction for the pipeline stages, and feeds that data to the output buffers. The two ADC channels are sampled simultaneously through a single encoding clock. All user-selected options are programmed through dedicated digital input pins or a serial port interface (SPI).

## ADC ARCHITECTURE

Each channel of the AD9284 consists of a differential input buffer followed by a sample-and-hold amplifier (SHA). The SHA is followed by a pipeline switched-capacitor ADC. The quantized outputs from each stage are combined into a final 8-bit result in the digital correction logic. The pipelined architecture permits the first stage to operate on a new input sample, whereas the remaining stages operate on preceding samples.

Each stage of the pipeline, excluding the last, consists of a low resolution flash ADC connected to a switched-capacitor DAC and interstage residue amplifier (MDAC). The residue amplifier magnifies the difference between the reconstructed DAC output and the flash input for the next stage in the pipeline. One bit of redundancy is used in each stage to facilitate digital correction of flash errors. The last stage consists of a flash ADC.

The input stage contains a differential SHA that can be ac- or dc-coupled in differential or single-ended mode. The output staging block aligns the data, carries out error correction, and passes the data to the output buffers. The output buffers are powered from a separate supply, allowing adjustment of the output voltage swing. During power-down, the output buffers enter a high impedance state.

## ANALOG INPUT CONSIDERATIONS

The analog inputs of the AD9284 are differentially buffered. For best dynamic performance, the source impedances driving VIN+A, VIN+B, VIN-A, and VIN-B should be matched such that common-mode settling errors are symmetrical. The analog inputs are optimized to provide superior wideband performance and must be driven differentially. SNR and SINAD performance degrades significantly if the analog inputs are driven with a single-ended signal.

A wideband transformer, such as Mini-Circuits® ADT1-1WT, can provide the differential analog inputs for applications that require a single-ended-to-differential conversion. Both analog inputs are self-biased by an on-chip resistor divider to a nominal 1.4 V.

## Differential Input Configurations

Optimum performance is achieved when driving the AD9284 in a differential input configuration. For baseband applications, the ADA4937-1 differential driver provides excellent performance and a flexible interface to the ADC (see Figure 19). The output common-mode voltage of the AD9284 is easily set to 1.4 V, and the driver can be configured in a Sallen-Key filter topology to provide band limiting of the input signal.

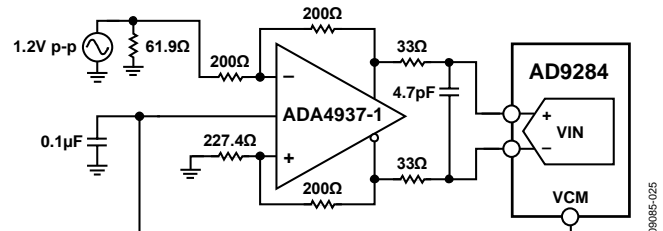

Figure 19. Differential Input Configuration Using the ADA4937-1

The AD9284 can also be driven passively with a differential transformer-coupled input (see Figure 20). To bias the analog input, the VCM voltage can be connected to the center tap of the secondary winding of the transformer.

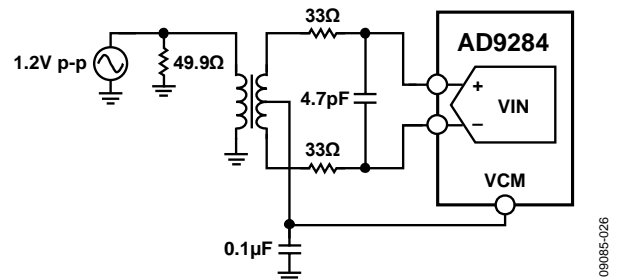

Figure 20. Differential Transformer-Coupled Configuration

The signal characteristics must be considered when selecting a transformer. Most RF transformers saturate at frequencies below a few megahertz (MHz). Excessive signal power can also cause core saturation, which leads to distortion.

## VOLTAGE REFERENCE

An internal differential voltage reference creates positive and negative reference voltages that define the 1.2 V p-p fixed span of the ADC core. This internal voltage reference can be adjusted by means of SPI control. It can also be driven externally with an off-chip stable reference. See the Memory Map Register Descriptions section for more details.

## RBIAS

The AD9284 requires the user to place a 10 kΩ resistor between the RBIAS pin and ground. This resistor, which is used to set the master current reference of the ADC core, should have a 1% tolerance.

**CLOCK INPUT CONSIDERATIONS**

For optimum performance, clock the AD9284 sample clock inputs, CLK+ and CLK- with a differential signal. The signal is typically ac-coupled into the CLK+ and CLK- pins via a transformer or capacitors.

**Clock Input Options**

The AD9284 has a very flexible clock input structure. The clock input can be an LVDS, LVPECL, or sine wave signal. Each configuration that is described in this section applies to CLK+ and CLK-.

Figure 21 and Figure 22 show the two preferred methods for clocking the AD9284. A low jitter clock source is converted from a single-ended signal to a differential signal using either an RF transformer or an RF balun. The back-to-back Schottky diodes across the transformer/balun secondary limit clock excursions into the AD9284 to approximately 0.8 V p-p differential.

This limit helps prevent the large voltage swings of the clock from feeding through to other portions of the AD9284, while preserving the fast rise and fall times of the signal that are critical to low jitter performance.

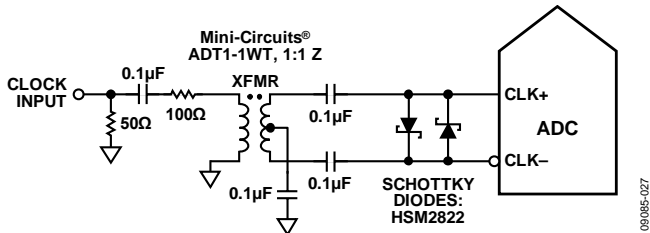

Figure 21. Transformer-Coupled Differential Clock

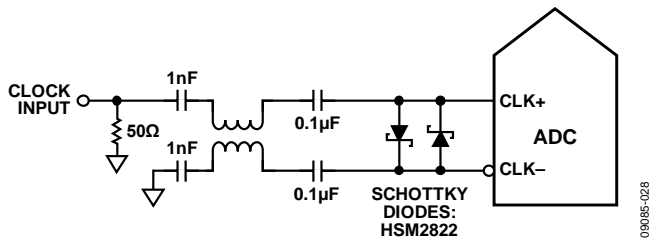

Figure 22. Balun-Coupled Differential Clock

If a low jitter clock source is not available, another option is to ac couple a differential PECL signal to the sample clock input pins, as shown in Figure 23. The AD9510/AD9511/AD9512/AD9513/AD9514/AD9515/AD9516/AD9517 clock drivers offer excellent jitter performance.

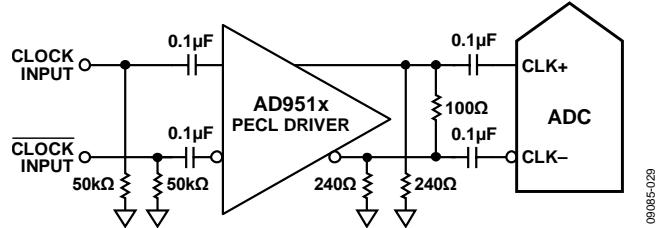

Figure 23. Differential PECL Sample Clock

A third option is to ac couple a differential LVDS signal to the sample clock input pins, as shown in Figure 24. The AD9510/AD9511/AD9512/AD9513/AD9514/AD9515/AD9516/AD9517 clock drivers offer excellent jitter performance.

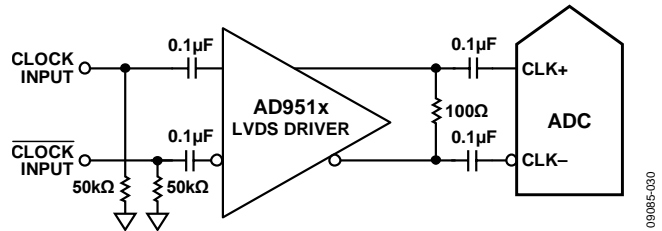

Figure 24. Differential LVDS Sample Clock

**DIGITAL OUTPUTS**

**Digital Output Enable Function (OE)**

The AD9284 has a flexible three-state ability for the digital output pins. The three-state mode is enabled using the OE pin. When OE is set to logic level high, the output drivers for both data buses are placed into a high impedance state.

## BUILT-IN SELF-TEST (BIST) AND OUTPUT TEST

The AD9284 includes a built-in self-test feature that is designed to enable verification of the integrity of each channel, as well as facilitate board level debugging. A built-in self-test (BIST) feature that verifies the integrity of the digital datapath of the AD9284 is included. Various output test options are also provided to place predictable values on the outputs of the AD9284.

### BUILT-IN SELF-TEST (BIST)

The BIST is a thorough test of the digital portion of the selected AD9284 signal path. Perform the BIST test after a reset to ensure that the part is in a known state. During BIST, data from an internal pseudorandom noise (PN) source is driven through the digital datapath of both channels, starting at the ADC block output. At the datapath output, CRC logic calculates a signature from the data. The BIST sequence runs for 512 cycles and then stops. When the test is completed, the BIST compares the signature results with a predetermined value. If the signatures match, the BIST sets Bit 0 of Register 0x0E, signifying that the test passed. If the BIST test fails, Bit 0 of Register 0x0E is cleared. The outputs are connected during this test, so the PN sequence can be observed as it runs.

Writing a value of 0x05 to Register 0x0E runs the BIST. This enables Bit 0 (BIST enable) of Register 0x0E and resets the PN sequence generator, Bit 2 (BIST init) of Register 0x0E. At the completion of the BIST, Bit 0 of Register 0x0E is automatically cleared. The PN sequence can be continued from its last value by writing a 0 to Bit 2 of Register 0x0E. However, if the PN sequence is not reset, the signature calculation does not equal the predetermined value at the end of the test. At that point, the user must rely on verifying the output data.

### OUTPUT TEST MODES

The output test options are described in Table 12 at Address 0x0D. When an output test mode is enabled, the analog section of the ADC is disconnected from the digital back-end blocks, and the test pattern is run through the output formatting block. Some test patterns are subject to output formatting, and some are not. The PN generators from the PN sequence tests can be reset by setting Bit 4 or Bit 5 of Register 0x0D. These tests can be performed with or without an analog signal (if present, the analog signal is ignored), but they do require an encode clock. For more information, see the [AN-877](#) Application Note, *Interfacing to High Speed ADCs via SPI*.



## SERIAL PORT INTERFACE (SPI)

The AD9284 serial port interface (SPI) allows the user to configure the converter for specific functions or operations through a structured register space provided inside the ADC. The SPI gives the user added flexibility and customization, depending on the application. Addresses are accessed via the serial port and can be written to or read from via the port. Memory is organized into bytes that can be further divided into fields, which are documented in the Memory Map section. For detailed operational information, see the [AN-877](#) Application Note, *Interfacing to High Speed ADCs via SPI*.

### CONFIGURATION USING THE SPI

Three pins define the SPI of this ADC: SCLK, SDIO, and CSB (see Table 9). SCLK (a serial clock) is used to synchronize the read and write data presented from and to the ADC. SDIO (serial data input/output) is a dual-purpose pin that allows data to be sent to and read from the internal ADC memory map registers. CSB (chip select bar) is an active low control that enables or disables the read and write cycles.

**Table 9. Serial Port Interface Pins**

Pin	Function
SCLK	Serial clock. A serial shift clock input that is used to synchronize serial interface reads and writes.
SDIO	Serial data input/output. A dual-purpose pin that typically serves as an input or an output, depending on the instruction being sent and the relative position in the timing frame.
CSB	Chip select bar. An active low control that gates the read and write cycles.

The falling edge of CSB, in conjunction with the rising edge of SCLK, determines the start of the framing. An example of the serial timing and its definitions can be found in Figure 25.

Other modes involving CSB are available. The CSB pin can be held low indefinitely, which permanently enables the device; this is called streaming. CSB can stall high between bytes to allow for additional external timing. When the CSB pin is tied high, SPI functions are placed in high impedance mode. This mode turns on any SPI pin secondary functions.

During the instruction phase, a 16-bit instruction is transmitted. Data follows the instruction phase, and its length is determined by the W0 and W1 bits, as shown in Figure 25.

All data is composed of 8-bit words. The first bit of the first byte in a multibyte serial data transfer frame indicates whether a read command or a write command is issued. This allows the serial data input/output (SDIO) pin to change direction from an input to an output at the appropriate point in the serial frame.

In addition to word length, the instruction phase determines whether the serial frame is a read or write operation, allowing the serial port to be used both to program the chip and to read the contents of the on-chip memory. If the instruction is a readback operation, the serial data input/output (SDIO) pin changes direction, from an input to an output, at the appropriate point in the serial frame.

Data can be sent in MSB-first mode or in LSB-first mode. MSB first is the default on power-up and can be changed via the SPI port configuration register. For more information about this and other features, see the [AN-877](#) Application Note, *Interfacing to High Speed ADCs via SPI*.

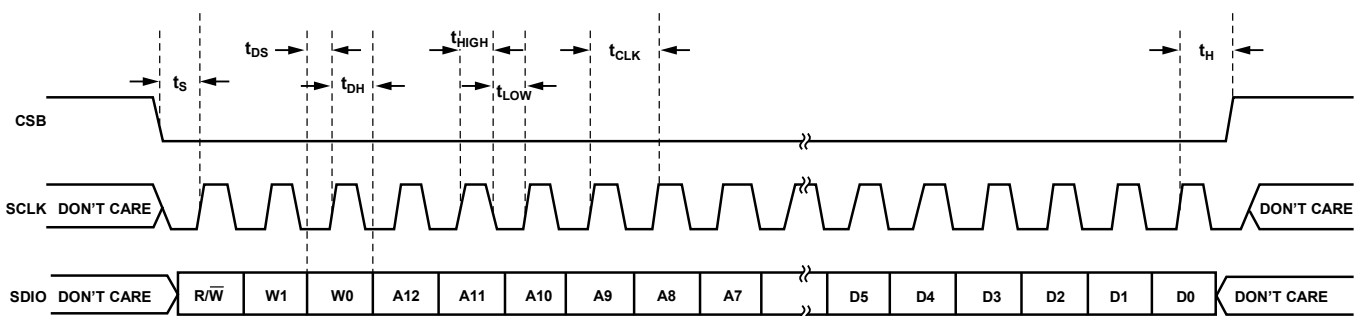

Figure 25. Serial Port Interface Timing Diagram

## HARDWARE INTERFACE

The pins described in Table 9 constitute the physical interface between the programming device of the user and the serial port of the AD9284. The SCLK and CSB pins function as inputs when using the SPI interface. The SDIO pin is bidirectional, functioning as an input during write phases and as an output during readback.

The SPI interface is flexible enough to be controlled by either FPGAs or microcontrollers. One method for SPI configuration is described in detail in the [AN-812](#) Application Note, *Microcontroller-Based Serial Port Interface (SPI) Boot Circuit*.

The SPI port should not be active during periods when the full dynamic performance of the converter is required. Because the SCLK, CSB, and SDIO signals are typically asynchronous to the ADC clock, noise from these signals can degrade converter performance. If the on-board SPI bus is used for other devices, it may be necessary to provide buffers between this bus and the AD9284 to prevent these signals from transitioning at the converter inputs during critical sampling periods.

SDIO/PWDN serves a dual function when the SPI interface is not being used. When the pin is strapped to AVDD or ground during device power-on, it is associated with a specific function. The mode selection table (see Table 10) describes the strappable functions that are supported on the AD9284.

**Table 10. Mode Selection**

Pin	External Voltage	Configuration
SDIO/PWDN	AVDD (default) AGND	Chip in full power-down Normal operation
$\overline{\text{OE}}$	AVDD AGND (default)	Outputs in high impedance Outputs enabled

## CONFIGURATION WITHOUT THE SPI

In applications that do not interface to the SPI control registers, the SDIO/PWDN pin serves as a standalone, CMOS-compatible control pin. When the device is powered up, it is assumed that the user intends to use the SDIO, SCLK, and CSB pins as static control lines for the output enable and power-down feature control. In this mode, connecting the CSB chip select to AVDD disables the serial port interface.

## SPI ACCESSIBLE FEATURES

Table 11 provides a brief description of the general features that are accessible via the SPI. These features are described in detail in the [AN-877](#) Application Note, *Interfacing to High Speed ADCs via SPI*. The AD9284 part-specific features are described in detail in Table 12.

**Table 11. Features Accessible Using the SPI**

Feature	Description
Mode	Allows the user to set either power-down mode or standby mode
Clock Offset	Allows the user to access the DCS via the SPI Allows the user to digitally adjust the converter offset
Test I/O	Allows the user to set test modes to have known data on output bits
Output Mode	Allows the user to set up outputs
Output Phase	Allows the user to set the output clock polarity
Output Delay	Allows the user to vary the DCO delay
Voltage Reference	Allows the user to set the voltage reference

## MEMORY MAP

### READING THE MEMORY MAP REGISTER TABLE

Each row in the memory map register table (see Table 12) has eight bit locations. The memory map is roughly divided into three sections: the chip configuration registers (Address 0x00 to Address 0x02), the device index and transfer registers (Address 0x05 and Address 0xFF), and the program registers (Address 0x08 to Address 0x25).

Table 12 documents the default hexadecimal value for each hexadecimal address shown. The column with the heading Bit 7 (MSB) is the start of the default hexadecimal value given. For more information on this function and others, see the [AN-877](#) Application Note, *Interfacing to High Speed ADCs via SPI*. This document details the functions controlled by Register 0x00 to Register 0xFF.

### Open Locations

All address and bit locations that are not included in the SPI map are not currently supported for this device. Unused bits of a valid address location should be written with 0s. Writing to these locations is required only when part of an address location is open. If the entire address location is open, it is omitted from the SPI map (for example, Address 0x13) and should not be written.

### Default Values

After the AD9284 is reset, critical registers are loaded with default values. The default values for the registers are given in the memory map register table (see Table 12).

### Logic Levels

An explanation of logic level terminology follows:

- “Bit is set” is synonymous with “bit is set to Logic 1” or “writing Logic 1 for the bit.”
- “Bit is cleared” is synonymous with “bit is set to Logic 0” or “writing Logic 0 for the bit.”

### Transfer Register Map

Address 0x08 to Address 0x38 are shadowed. Writes to these addresses do not affect part operation until a transfer command is issued by writing 0x01 to Address 0xFF, setting the transfer bit. Setting the transfer bit allows these registers to be updated internally and simultaneously. The internal update takes place when the transfer bit is set, and then the bit autoclears.

### Channel-Specific Registers

Some channel setup functions can be programmed differently for each channel. In these cases, channel address locations are internally duplicated for each channel. These registers and bits are designated in the memory map register table as local. These local registers and bits can be accessed by setting the appropriate Channel A (Bit 0) or Channel B (Bit 1) bits in Register 0x05.

If both bits are set, the subsequent write affects the registers of both channels. In a read cycle, set only Channel A or Channel B to read one of the two registers. If both bits are set during a SPI read cycle, the part returns the value for Channel A. Registers and bits designated as global in the memory map register table affect the entire part or the channel features for which independent settings are not allowed between channels. The settings in Register 0x05 do not affect the global registers and bits.

**MEMORY MAP REGISTER TABLE**

All address and bit locations that are not included in Table 12 are not currently supported for this device.

**Table 12. Memory Map Registers**

Addr (Hex)	Register Name	Bit 7 (MSB)	Bit 6	Bit 5	Bit 4	Bit 3	Bit 2	Bit 1	Bit 0 (LSB)	Default Value (Hex)	Default Notes/ Comments
<b>Chip Configuration Registers</b>											
0x00	SPI port configuration	0	LSB first	Soft reset	1	1	Soft reset	LSB first	0	0x18	Nibbles are mirrored so that LSB-first or MSB-first mode registers correctly, regardless of shift mode
0x01	Chip ID (global)	8-bit chip ID								0x0A	Unique chip ID used to differentiate devices; read only
0x02	Chip grade (global)	Open	Speed grade ID 000 = 250 MSPS			Open			0x00	Unique speed grade ID is used to differentiate devices; read only	
<b>Device Index and Transfer Registers</b>											
0x05	Device Index A	Open						ADC B default	ADC A default	0xFF	Bits are set to determine which on-chip device receives the next write command; default is all devices on the chip
0xFF	Transfer	Open							Transfer	0xFF	Synchronous transfer of data from the master shift register to the slave
<b>Program Registers (May or may not be indexed by device index)</b>											
0x08	Modes (global)	Open					Internal power-down mode 00: chip run 01: full power-down 10: reserved 11: reserved			0x00	Determines various generic modes of chip operation
0x09	Clock (global)	Open						Clock boost	Duty cycle stabilizer	0x01	
0x0D	Test mode (local)	Open	Reset PN23 gen	Reset PN9 gen	Open	Output test mode 000: off 001: midscale short 010: +FS short 011: -FS short 100: checkerboard output 101: PN23 sequence 110: PN9 sequence 111: one-/zero-word toggle				0x00	When test mode is set, test data is placed on the output pins in place of normal data
0x0E	BIST (local)	Open					BIST init	Open	BIST enable	0x00	BIST mode config

Addr (Hex)	Register Name	Bit 7 (MSB)	Bit 6	Bit 5	Bit 4	Bit 3	Bit 2	Bit 1	Bit 0 (LSB)	Default Value (Hex)	Default Notes/Comments
0x0F	ADC input (global/local)	Open					Analog disconnect (local)	Common-mode input enable (global)	Open	0x00	
0x10	Offset (local)	Open				Offset adjust (twos complement format) 0111: +7 0110: +6 ... 0001: +1 0000: 0 1111: -1 ... 1001: -7 1000: -8				0x00	Device offset trim
0x14	Output mode (local)	Open			Output enable	Open	Output invert	Data format select 00: offset binary 01: twos complement 10: Gray code 11: reserved		0x00	Configures the outputs and the format of the data
0x16	Output phase (global)	DCO invert	Open						0x00		
0x18	Voltage reference (global)	Open			Voltage reference and input full-scale adjustment (see Table 13)					0x00	Selects/adjusts $V_{REF}$
0x24	MISR LSB (local)	LSBs of multiple input shift register (MISR)								0x00	MISR least significant byte; read only
0x25	MISR MSB (local)	MSBs of multiple input shift register (MISR)								0x00	MISR most significant byte; read only

**MEMORY MAP REGISTER DESCRIPTIONS**

For more information about functions controlled in Register 0x00 to Register 0xFF, see the [AN-877](#) Application Note, *Interfacing to High Speed ADCs via SPI*.

**Voltage Reference (Register 0x18)**

**Bits[7:5]—Reserved**

**Bits[4:0]—Voltage Reference**

Bits[4:0] scale the internally generated voltage reference and, consequently, the full scale of the analog input. Within this register, the reference driver can be configured to be more easily driven externally by reducing the capacitive loading.

The relationship between the  $V_{REF}$  voltage and the input full scale is described by Equation 1. See Table 13 for a complete list of register settings.

$$Input\_Full\_Scale = V_{REF} \times 1.2 \quad (1)$$

**Table 13.  $V_{REF}$  and Input Full Scale (Register 0x18)**

Value	$V_{REF}$ (V)	Full Scale (V)
0x14	0.844	1.013
0x15	0.857	1.028
0x16	0.87	1.044
0x17	0.883	1.060
0x18	0.896	1.075
0x19	0.909	1.091
0x1A	0.922	1.106
0x1B	0.935	1.122
0x1C	0.948	1.138
0x1D	0.961	1.153
0x1E	0.974	1.169
0x1F	0.987	1.184
0x00	1	1.200
0x01	1.013	1.216
0x02	1.026	1.231
0x03	1.039	1.247
0x04	1.052	1.262
0x05	1.065	1.278
0x06	1.078	1.294
0x07	1.091	1.309
0x08	1.104	1.325
0x09	1.117	1.340
0x0A	1.13	1.356
0x0B	1.143	1.372
0x0C	1.156	1.387
0x0D	1.169	1.403
0x0E	1.182	1.418
0x0F	1.195	1.434
0x10	1.208	1.450
0x11	1.221	1.465
0x12	1.234	1.481
0x13	External	External x 1.2

## APPLICATIONS INFORMATION

### DESIGN GUIDELINES

Before starting design and layout of the AD9284 as a system, it is recommended that the designer become familiar with these guidelines, which discuss the special circuit connections and layout requirements that are needed for certain pins.

#### **Power and Ground Recommendations**

When connecting power to the AD9284, it is strongly recommended that two separate supplies be used. Use one 1.8 V supply for analog (AVDD); use a separate 1.8 V supply for the digital output supply (DRVDD). If a common 1.8 V AVDD and DRVDD supply must be used, the AVDD and DRVDD domains must be isolated with a ferrite bead or filter choke and separate decoupling capacitors. Several different decoupling capacitors can be used to cover both high and low frequencies. Locate these capacitors close to the point of entry at the printed circuit board (PCB) level and close to the pins of the part, with minimal trace length.

A single PCB ground plane should be sufficient when using the AD9284. With proper decoupling and smart partitioning of the PCB analog, digital, and clock sections, optimum performance is easily achieved.

#### **Exposed Paddle Thermal Heat Sink Recommendations**

The exposed paddle (Pin 0) is the only ground connection for the AD9284; therefore, it must be connected to analog ground (AGND) on the customer PCB. To achieve the best electrical and thermal performance, mate an exposed (no solder mask), continuous copper plane on the PCB to the AD9284 exposed paddle, Pin 0.

The copper plane should have several vias to achieve the lowest possible resistive thermal path for heat dissipation to flow through the bottom of the PCB. Fill or plug these vias with nonconductive epoxy.

To maximize the coverage and adhesion between the ADC and the PCB, a silkscreen should be overlaid to partition the continuous plane on the PCB into several uniform sections. This provides several tie points between the ADC and the PCB during the reflow process. Using one continuous plane with no partitions guarantees only one tie point between the ADC and the PCB. For detailed information about packaging and PCB layout of chip scale packages, see the [AN-772](#) Application Note, *A Design and Manufacturing Guide for the Lead Frame Chip Scale Package (LFCSP)*, at [www.analog.com](http://www.analog.com).

#### **VCM**

The VCM pin should be decoupled to ground with a 0.1  $\mu\text{F}$  capacitor.

#### **RBIAS**

The AD9284 requires that a 10 k $\Omega$  resistor be placed between the RBIAS pin and ground. This resistor, which sets the master current reference of the ADC core, should have at least a 1% tolerance.

#### **Reference Decoupling**

Decouple the VREF pin externally to ground with a low ESR, 1.0  $\mu\text{F}$  capacitor in parallel with a low ESR, 0.1  $\mu\text{F}$  ceramic capacitor.

#### **SPI Port**

The SPI port should not be active during periods when the full dynamic performance of the converter is required. Because the SCLK, CSB, and SDIO signals are typically asynchronous to the ADC clock, noise from these signals can degrade converter performance. If the on-board SPI bus is used for other devices, it may be necessary to provide buffers between this bus and the AD9284 to prevent these signals from transitioning at the converter inputs during critical sampling periods.

# OUTLINE DIMENSIONS

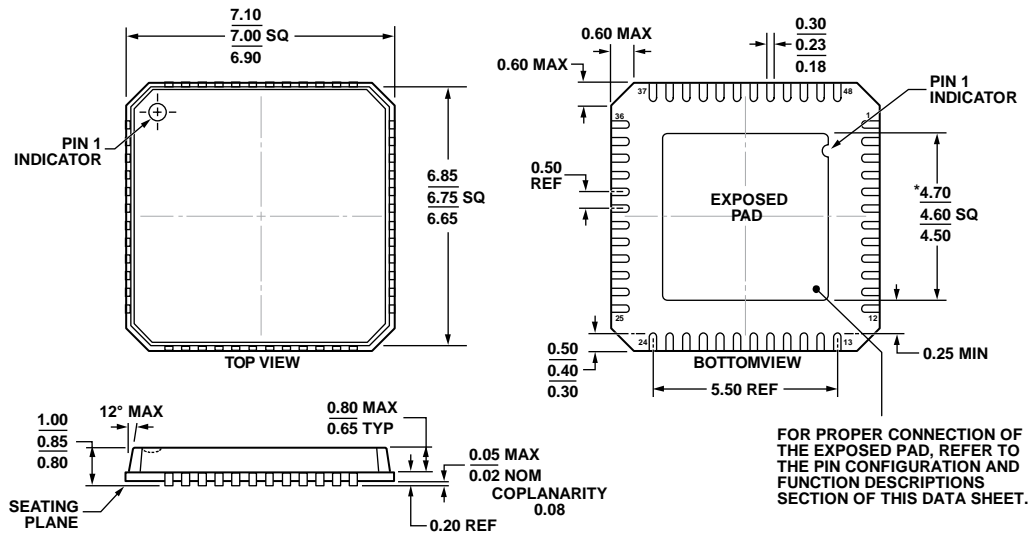

\*COMPLIANT TO JEDEC STANDARDS MO-220-VKGD-2  
WITH EXCEPTION TO EXPOSED PAD DIMENSION

Figure 26. 48-Lead Lead Frame Chip Scale Package [LFCSP\_VQ]  
7 mm × 7 mm Body, Very Thin Quad  
(CP-48-12)  
Dimensions shown in millimeters

06-07-2012-A

## ORDERING GUIDE

Model <sup>1</sup>	Temperature Range	Package Description	Package Option
AD9284BCPZ-250	-40°C to +85°C	48-Lead Lead Frame Chip Scale Package [LFCSP_VQ]	CP-48-12
AD9284BCPZRL7-250	-40°C to +85°C	48-Lead Lead Frame Chip Scale Package [LFCSP_VQ]	CP-48-12
AD9284-250EBZ		Evaluation Board	

<sup>1</sup> Z = RoHS Compliant Part.



**NOTES**