

RG 90-18/50

AC centrifugal compact fan

single-intake

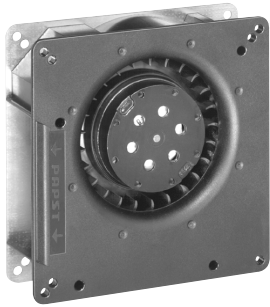

ebm-papst St. Georgen GmbH & Co. KG

Hermann-Papst-Str. 1
D-78112 St. Georgen
Phone +49 (0) 7724 81-0
Fax +49 (0) 7724 81-1309
info2@de.ebmpapst.com
www.ebmpapst.com

Nominal data

Type	RG 90-18/50	
Phase		1~
Nominal voltage	VAC	230
Frequency	Hz	50
Speed (rpm)	min ⁻¹	2200
Power consumption	W	22.0
Min. ambient temperature	°C	-30
Max. ambient temperature	°C	60
Air flow	m ³ /h	54
Sound power level	B	5.8

ml = Max. load · me = Max. efficiency · fa = Free air · cs = Customer specification · ce = Customer equipment
Subject to change



Technical description

General description	Forward-curved impeller
Housing material	Scroll housing made of glass-fiber reinforced PBT plastic, housing base made of sheet steel
Weight	0.560 kg
Dimensions	135 x 135 x 38 mm
Impeller material	Glass-fiber reinforced PA plastic
Airflow direction	Radial: discharge through window in housing
Direction of rotation	Clockwise, viewed toward rotor
Storage	Sintec sleeve bearing
Service life L10 at 40 °C	35000 h
Service life L10 at maximum temperature	22500 h
Cable	2 leads AWG 22
Motor protection	Protected from overload by impedance protection
Approval	VDE, CSA, UL, CE

Product drawing

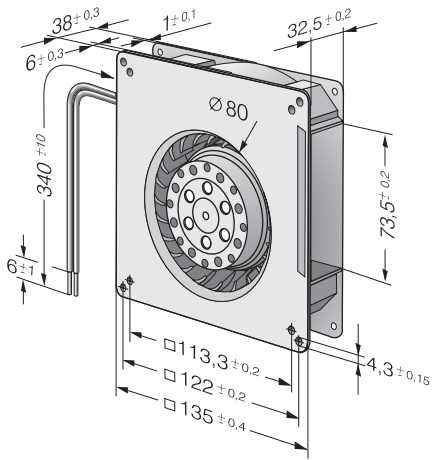

Curves: Air performance

