



ADuCM362/ADuCM363 Development Systems Getting Started Tutorial

FEATURES

ADuCM362/ADuCM363 evaluation board

2 power supply options: 5 V from a USB port connected to the Segger J-Link OB emulator or 1.8 V to 3.6 V from an external power supply

On-board resistance temperature detector (RTD) for temperature measurements

Access to all analog and digital pins

Power and general-purpose LEDs

Reset and download push-buttons

8-pin connector to the Segger J-Link OB emulator

32.768 kHz external crystal

EVALUATION KIT CONTENTS

An evaluation board ([EVAL-ADuCM362QSPZ](#) or [EVAL-ADuCM363QSPZ](#)) that facilitates performance evaluation of the device with minimal external components

An Analog Devices, Inc., Segger J-Link OB emulator (USB-SWD/UART-EMUZ)

1 USB cable

1 installation DVD

ONLINE RESOURCES

[ADuCM362/ADuCM363 data sheet](#)

[ADuCM362/ADuCM363 Hardware Reference Manual](#)

GENERAL DESCRIPTION

The [ADuCM362/ADuCM363](#) development system allows evaluation of [ADuCM362](#) or [ADuCM363](#) silicon. This quick start guide introduces the support features and tools supplied with the [ADuCM362/ADuCM363](#) evaluation kit. In addition, this guide describes how to connect the evaluation hardware.

The getting started guide works as a tutorial, providing instructions on how to download third party evaluation software tools. Instructions are also provided on how to load code examples supplied with the software tools.

The [ADuCM362](#) is a fully integrated, 4 kSPS, 24-bit data acquisition system that incorporates dual, high performance multichannel sigma-delta (Σ - Δ) analog-to-digital converters (ADCs), a 32-bit ARM[®] Cortex[®]-M3 processor, and Flash/EE memory on a single chip.

The [ADuCM362](#) is designed for direct interfacing to external precision sensors in both wired and battery-powered applications. The [ADuCM363](#) contains all the features of the [ADuCM362](#) except for the ADC0, which is removed.

This guide gives users the ability to generate and download user code for use in unique end system requirements.

Complete specifications for the [ADuCM362/ADuCM363](#) are provided in the [ADuCM362/ADuCM363](#) data sheet and should be consulted in conjunction with this user guide when using the evaluation board.

EVAL-ADuCM362QSPZ/EVAL-ADuCM363QSPZ EVALUATION BOARD

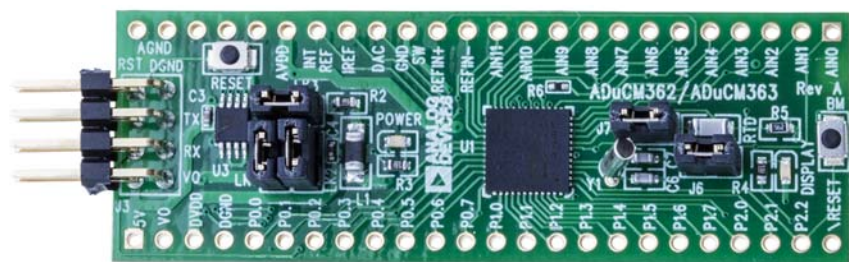

Figure 1.

TABLE OF CONTENTS

| | | | |
|---|---|---|---|
| Features | 1 | Keil μ Vision5..... | 3 |
| Evaluation Kit Contents..... | 1 | IAR Embedded Workbench..... | 4 |
| Online Resources..... | 1 | Elves.exe..... | 4 |
| General Description | 1 | Evaluation Board Setup Procedures | 4 |
| EVAL-ADuCM362QSPZ/EVAL-ADuCM363QSPZ evaluation board..... | 1 | Windows Serial Downloader | 5 |
| Revision History | 2 | Preparing for Download..... | 5 |
| Getting Started | 3 | Downloading Using CM3WSD..... | 5 |
| Software Installation Procedures..... | 3 | Running the Downloaded File | 5 |

REVISION HISTORY

10/2016—Revision 0: Initial Version

GETTING STARTED

SOFTWARE INSTALLATION PROCEDURES

Perform the steps described in this section before plugging any USB devices into the PC.

1. Close all open applications.
2. Insert the installation DVD into the DVD drive.
3. Double-click **ADuCM36x.exe** and follow the on-screen instructions. A menu displays installation options as shown in Figure 2.

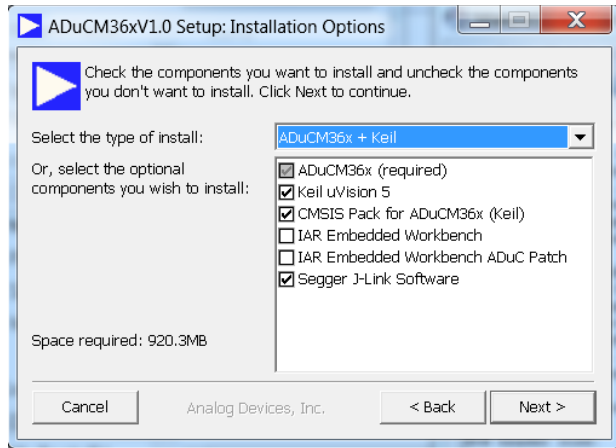

Figure 2. Installation Options

The following components install by default:

- Example code and function sets for most peripherals.
- An **Elves.exe** application to easily choose functions from the provided function sets followed by choosing from the function parameters.

The following components are optional installations:

- Keil development tools (a compiler, debugger, and programming tools). The Keil μ Vision 5 software version is used.
- IAR Embedded Workbench development tools (a compiler, debugger, and programming tools).
- Segger J-Link drivers for the J-Link emulator.

The J-Link software is selected by default in the installation menu, shown in Figure 2. It is advised to leave it selected. The J-Link software automatically installs the J-Link serial port driver. Select **Install USB Driver for J-Link-OB with CDC**, shown in Figure 3. If that step is missed, run **JLinkCDCInstaller_V1.2b.exe** located in the **ADuCM36x\Segger** folder.

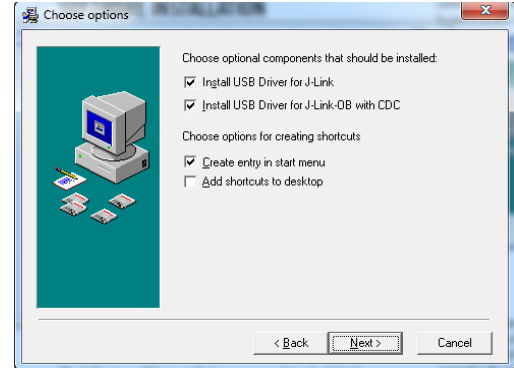

Figure 3. Installing Link Software

If using the IAR tools, the entire contents of the supplied **arm** directory (for example, **C:\ADuCM36x...IAR\IAR_M36x_Patch.zip\arm**) must be copied to the IAR tools directory (for example, **C:\Program Files\IAR Systems\Embedded Workbench 7.3 Kickstart\arm**).

Future updates are available from the Analog Devices FTP website.

KEIL μ VISION5

The Keil μ Vision5 integrated development environment (IDE) integrates all the tools necessary to edit, assemble, and debug code. The fastest way to start is to open an existing Keil μ Vision5 project by following these steps:

1. In Keil μ Vision5, select **Project > Open Project**.
2. Browse to the folder where the **ADuCM362/ADuCM363** software is installed (such as, **C:\ADuCM36x...**).
3. Open the file **DIO.uvproj** in the folder **code\ADuCM362\examples\DIO**. This file launches an example project.
4. Compile and download to the **ADuCM362/ADuCM363** on the evaluation board.
5. To run the example code, press **RESET** on the evaluation board or enter debug mode by clicking the **Start/Stop Debug Session (Ctrl+F5)** button (see Figure 4) and then click **Run (F5)** (see Figure 5).

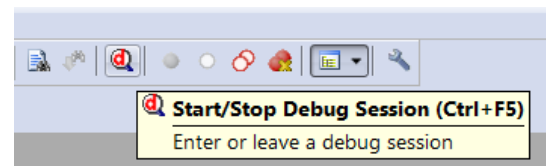

Figure 4. Download and Debug Button

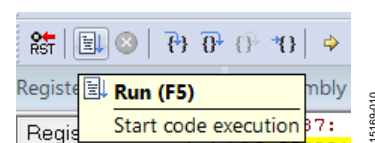

Figure 5. Run (F5) Button

6. When running, the red LED marked **DISPLAY** on the evaluation board flashes.

IAR EMBEDDED WORKBENCH

The IAR Embedded Workbench integrates all the tools necessary to edit, assemble, and debug code. The fastest way to get started is to open an existing workspace by following these steps:

1. Open the IAR tools from the **Start Menu**.
2. Within the IAR IDE, click **File > Open > Workspace** and open a workspace provided by Analog Devices (for example, C:\ADuCM36x...\code\ADuCM362\examples\Blink\DI O.eww).
3. Compile and download the code to the device using **Project > Rebuild All** and then **Project > Download Active Application**.
4. Click **No** if a pop-up window appears identifying an unknown device.
5. To run the code, press RESET on the evaluation board or enter debug mode by clicking the **Download and Debug** button (see Figure 6) and then click **Go** (see Figure 7).

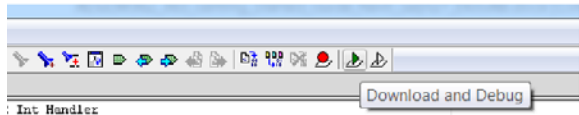

Figure 6. Download and Debug Button

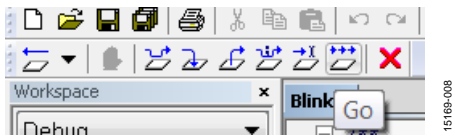

Figure 7. Go Button

6. When running, the red LED marked DISPLAY on the evaluation board flashes.

ELVES.EXE

Elves.exe is an application that chooses functions from the provided function sets and function parameters. Elves.exe can be integrated into the Keil μVision5 and IAR tools under the tool menus. For instructions, run **Elves.exe** (for example, at C:\ADuCM36x...\Software Tools\Elves\Elves.exe) and press the F1 key or click the **Help** button.

EVALUATION BOARD SETUP PROCEDURES

Assembling and Connecting the Hardware

Do not plug in the USB cable before the software is installed. Use the following steps to connect the hardware:

1. Insert the USB cable provided between the PC and the J-Link OB emulator (emulator shown in Figure 8).
2. The red LED (LED1) flashes until initialization of the drivers completes.

3. Details for installation of the drivers appear on the screen the first time the user plugs the evaluation board into the PC or if using a different USB port. Allow the installation of these drivers to complete as they provide a virtual communication port on the PC that allows the evaluation board to appear as a virtual serial communication port to the UART port of the ADuCM362/ADuCM363 device.
4. If using the virtual serial communication port to the UART, ensure Jumpers LK3 and LK5 are in place on the evaluation board (see Figure 9).
5. Plug the 10-pin DIL connector of the J-Link OB emulator into the EVAL-ADuCM362QSPZ or EVAL-ADuCM363QSPZ
6. The evaluation board is powered by computer from the the USB cable connected to the J-Link OB emulator. The green POWER LED turns on.

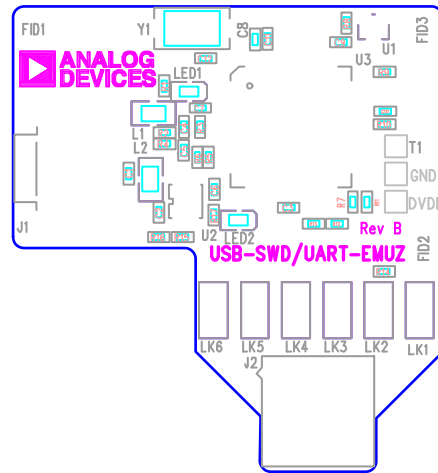
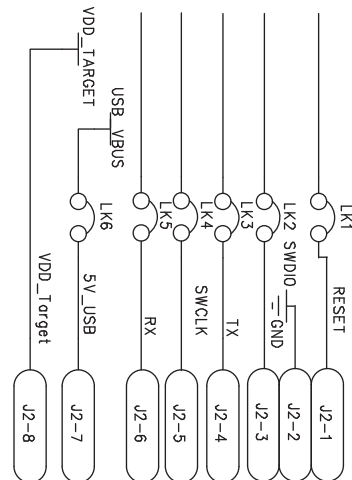

Figure 8. Emulator, Top View



TO MINIKIT BOARD CONNECTOR

Figure 9. J-Link OB Connection Details

WINDOWS SERIAL DOWNLOADER

The Windows® Serial Downloader for Cortex-M3-based devices (named CM3WSD.exe) is a Windows software program that allows a user to serially download Intel Extended Hex files as created by assembler/compiler to the [ADuCM362/ADuCM363](#) via the serial port. The Intel Extended Hex file is downloaded into the on-chip Flash/EE program memory via a selected PC serial port.

PREPARING FOR DOWNLOAD

1. Connect the [EVAL-ADuCM362QSPZ](#) or [EVAL-ADuCM363QSPZ](#) to the USB-SWD/UART-EMUZ emulator board, and the USB-SWD/UART-EMUZ to the PC using a USB cable.
2. Ensure all links are inserted on both boards.
3. Place the [ADuCM362/ADuCM363](#) into serial download mode using the following sequence:
4. Pull the P2.2 pin low.
5. Pull the RESET pin low and then high (float).
6. P2.2 can be left floating once the RESET pin is high.

DOWNLOADING USING CM3WSD

1. In the software tools \CM3WSD folder, open the file **CM3WSD.exe**.
2. Select the file at `C:\ADuCM36x...\code\ADuCM362\examples\Blink\Obj\Blink.hex`.
3. In the **Serial Port** drop-down menu, select the **JLink CDC UART Port** and a baud rate of 38400.
4. Select **Start**. The CM3WSD sends a reset command to the [ADuCM362/ADuCM363](#). If the [ADuCM362/ADuCM363](#) is in serial download mode and the COM port between the PC and the [EVAL-ADuCM362QSPZ](#) or [EVAL-ADuCM363QSPZ](#) are setup correctly, then the CM3WSD begins downloading the hex file and displays a progress bar while the file is downloading. Once the file successfully downloads, the monitor status box updates with the message **Flashing Complete Click Reset to run program**.

RUNNING THE DOWNLOADED FILE

Running Using the CM3WSD

Select **Reset** with the P2.2 pin floating or pulled high. The monitor status box updates with the message **Running**.

Manual Run Option

Pull the RESET pin low, then high (or float) on the [EVAL-ADuCM362QSPZ](#) or [EVAL-ADuCM363QSPZ](#) to reset the [ADuCM362/ADuCM363](#), with the P2.2 pin floating or pulled high. The program starts running automatically.

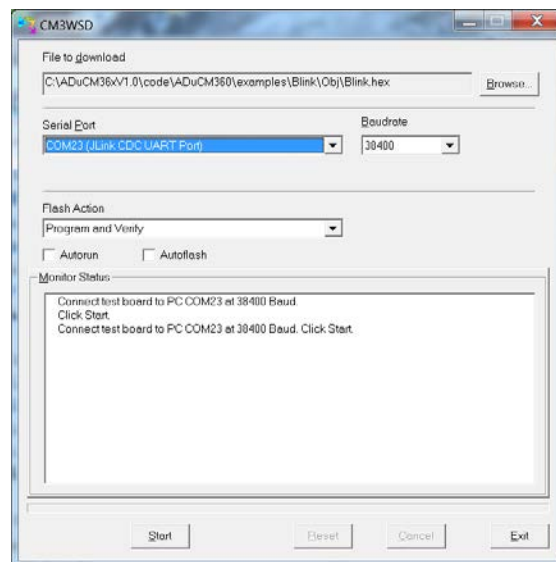

Figure 10. Preparing for Download

NOTES

**ESD Caution**

ESD (electrostatic discharge) sensitive device. Charged devices and circuit boards can discharge without detection. Although this product features patented or proprietary protection circuitry, damage may occur on devices subjected to high energy ESD. Therefore, proper ESD precautions should be taken to avoid performance degradation or loss of functionality.

Legal Terms and Conditions

By using the evaluation board discussed herein (together with any tools, components documentation or support materials, the "Evaluation Board"), you are agreeing to be bound by the terms and conditions set forth below ("Agreement") unless you have purchased the Evaluation Board, in which case the Analog Devices Standard Terms and Conditions of Sale shall govern. Do not use the Evaluation Board until you have read and agreed to the Agreement. Your use of the Evaluation Board shall signify your acceptance of the Agreement. This Agreement is made by and between you ("Customer") and Analog Devices, Inc. ("ADI"), with its principal place of business at One Technology Way, Norwood, MA 02062, USA. Subject to the terms and conditions of the Agreement, ADI hereby grants to Customer a free, limited, personal, temporary, non-exclusive, non-sublicensable, non-transferable license to use the Evaluation Board FOR EVALUATION PURPOSES ONLY. Customer understands and agrees that the Evaluation Board is provided for the sole and exclusive purpose referenced above, and agrees not to use the Evaluation Board for any other purpose. Furthermore, the license granted is expressly made subject to the following additional limitations: Customer shall not (i) rent, lease, display, sell, transfer, assign, sublicense, or distribute the Evaluation Board; and (ii) permit any Third Party to access the Evaluation Board. As used herein, the term "Third Party" includes any entity other than ADI, Customer, their employees, affiliates and in-house consultants. The Evaluation Board is NOT sold to Customer; all rights not expressly granted herein, including ownership of the Evaluation Board, are reserved by ADI. CONFIDENTIALITY. This Agreement and the Evaluation Board shall all be considered the confidential and proprietary information of ADI. Customer may not disclose or transfer any portion of the Evaluation Board to any other party for any reason. Upon discontinuation of use of the Evaluation Board or termination of this Agreement, Customer agrees to promptly return the Evaluation Board to ADI. ADDITIONAL RESTRICTIONS. Customer may not disassemble, decompile or reverse engineer chips on the Evaluation Board. Customer shall inform ADI of any occurred damages or any modifications or alterations it makes to the Evaluation Board, including but not limited to soldering or any other activity that affects the material content of the Evaluation Board. Modifications to the Evaluation Board must comply with applicable law, including but not limited to the RoHS Directive. TERMINATION. ADI may terminate this Agreement at any time upon giving written notice to Customer. Customer agrees to return to ADI the Evaluation Board at that time. LIMITATION OF LIABILITY. THE EVALUATION BOARD PROVIDED HEREUNDER IS PROVIDED "AS IS" AND ADI MAKES NO WARRANTIES OR REPRESENTATIONS OF ANY KIND WITH RESPECT TO IT. ADI SPECIFICALLY DISCLAIMS ANY REPRESENTATIONS, ENDORSEMENTS, GUARANTEES, OR WARRANTIES, EXPRESS OR IMPLIED, RELATED TO THE EVALUATION BOARD INCLUDING, BUT NOT LIMITED TO, THE IMPLIED WARRANTY OF MERCHANTABILITY, TITLE, FITNESS FOR A PARTICULAR PURPOSE OR NONINFRINGEMENT OF INTELLECTUAL PROPERTY RIGHTS. IN NO EVENT WILL ADI AND ITS LICENSORS BE LIABLE FOR ANY INCIDENTAL, SPECIAL, INDIRECT, OR CONSEQUENTIAL DAMAGES RESULTING FROM CUSTOMER'S POSSESSION OR USE OF THE EVALUATION BOARD, INCLUDING BUT NOT LIMITED TO LOST PROFITS, DELAY COSTS, LABOR COSTS OR LOSS OF GOODWILL. ADI'S TOTAL LIABILITY FROM ANY AND ALL CAUSES SHALL BE LIMITED TO THE AMOUNT OF ONE HUNDRED US DOLLARS (\$100.00). EXPORT. Customer agrees that it will not directly or indirectly export the Evaluation Board to another country, and that it will comply with all applicable United States federal laws and regulations relating to exports. GOVERNING LAW. This Agreement shall be governed by and construed in accordance with the substantive laws of the Commonwealth of Massachusetts (excluding conflict of law rules). Any legal action regarding this Agreement will be heard in the state or federal courts having jurisdiction in Suffolk County, Massachusetts, and Customer hereby submits to the personal jurisdiction and venue of such courts. The United Nations Convention on Contracts for the International Sale of Goods shall not apply to this Agreement and is expressly disclaimed.