

Quad, 12-Bit, 65MSPS, 1.8V ADC with Serial LVDS Outputs

ABSOLUTE MAXIMUM RATINGS

AV _{DD} to GND.....	-0.3V to +2.0V	\bar{V}/B , LVDSTEST to GND	-0.3V to (AV _{DD} + 0.3V)
CV _{DD} to GND	-0.3V to +3.6V	REFIO, REFADJ, CMOUT to GND	-0.3V to (AV _{DD} + 0.3V)
OV _{DD} to GND	-0.3V to +2.0V	I.C. to GND.....	-0.3V to (AV _{DD} + 0.3V)
IN _P , IN _N to GND.....	-0.3V to (AV _{DD} + 0.3V)	Continuous Power Dissipation (T _A = +70°C)	
CLK to GND.....	-0.3V to (CV _{DD} + 0.3V)	68-Pin QFN 10mm x 10mm x 0.9mm	
OUT _P , OUT _N , FRAME ₊ , CLKOUT ₊ to GND.....	-0.3V to (OV _{DD} + 0.3V)	(derated 41.7mW/°C above +70°C).....	3333.3mW
DT, SLVS/LVDS to GND	-0.3V to (AV _{DD} + 0.3V)	Operating Temperature Range	-40°C to +85°C
PLL0, PLL1, PLL2, PLL3 to GND	-0.3V to (AV _{DD} + 0.3V)	Maximum Junction Temperature	+150°C
PD0, PD1, PD2, PD3, PDALL to GND.....	-0.3V to (AV _{DD} + 0.3V)	Storage Temperature Range	-65°C to +150°C
		Lead Temperature Range (soldering, 10s).....	+300°C

Stresses beyond those listed under "Absolute Maximum Ratings" may cause permanent damage to the device. These are stress ratings only, and functional operation of the device at these or any other conditions beyond those indicated in the operational sections of the specifications is not implied. Exposure to absolute maximum rating conditions for extended periods may affect device reliability.

ELECTRICAL CHARACTERISTICS

(AV_{DD} = 1.8V, OV_{DD} = 1.8V, CV_{DD} = 1.8V, GND = 0, external V_{REFIO} = 1.24V, REFADJ = AV_{DD}, C_{REFIO} to GND = 0.1μF, f_{CLK} = 65MHz (50% duty cycle), DT = 0, T_A = T_{MIN} to T_{MAX}, unless otherwise noted. Typical values are at T_A = +25°C.) (Note 1)

PARAMETER	SYMBOL	CONDITIONS	MIN	TYP	MAX	UNITS
DC ACCURACY						
Resolution	N		12			Bits
Integral Nonlinearity	INL	(Note 2)		±0.4		LSB
Differential Nonlinearity	DNL	(Note 2)		±0.25		LSB
Offset Error		Fixed external reference (Note 2)			±1	% FS
Gain Error		Fixed external reference (Note 2)			±1.5	% FS
ANALOG INPUTS (IN_P, IN_N)						
Input Differential Range	V _{ID}	Differential input		1.4		V _{P-P}
Common-Mode Voltage Range	V _{CMO}	(Note 3)		0.76		V
Differential Input Impedance	R _{IN}	Switched capacitor load		2		kΩ
Differential Input Capacitance	C _{IN}			12.5		pF
CONVERSION RATE						
Maximum Conversion Rate	f _S MAX		65			MHz
Minimum Conversion Rate	f _S MIN			4		MHz
Data Latency				6.5		Cycles
DYNAMIC CHARACTERISTICS (differential inputs, 4096-point FFT)						
Signal-to-Noise Ratio (Note 2)	SNR	f _{IN} = 5.3MHz at -0.5dBFS		69.7		dB
		f _{IN} = 19.3MHz at -0.5dBFS, T _A ≥ +25°C	66.6	69.6		
		f _{IN} = 30.3MHz at -0.5dBFS		69.4		
Signal-to-Noise and Distortion (First Four Harmonics) (Note 2)	SINAD	f _{IN} = 5.3MHz at -0.5dBFS		69.6		dB
		f _{IN} = 19.3MHz at -0.5dBFS, T _A ≥ +25°C	66.5	69.5		
		f _{IN} = 30.3MHz at -0.5dBFS		69.3		
Effective Number of Bits (Note 2)	ENOB	f _{IN} = 5.3MHz at -0.5dBFS		11.4		Bits
		f _{IN} = 19.3MHz at -0.5dBFS, T _A ≥ +25°C		11.4		
		f _{IN} = 30.3MHz at -0.5dBFS		11.3		

Quad, 12-Bit, 65Mps, 1.8V ADC with Serial LVDS Outputs

MAX1127

ELECTRICAL CHARACTERISTICS (continued)

(AV_{DD} = 1.8V, OV_{DD} = 1.8V, CV_{DD} = 1.8V, GND = 0, external V_{REFIO} = 1.24V, REFADJ = AV_{DD}, C_{REFIO} to GND = 0.1μF, f_{CLK} = 65MHz (50% duty cycle), DT = 0, T_A = T_{MIN} to T_{MAX}, unless otherwise noted. Typical values are at T_A = +25°C.) (Note 1)

PARAMETER	SYMBOL	CONDITIONS	MIN	TYP	MAX	UNITS
Spurious-Free Dynamic Range (Note 2)	SFDR	f _{IN} = 5.3MHz at -0.5dBFS		93.3		dBc
		f _{IN} = 19.3MHz at -0.5dBFS, T _A ≥ +25°C	77.5	92		
		f _{IN} = 30.3MHz at -0.5dBFS		88.9		
Total Harmonic Distortion (Note 2)	THD	f _{IN} = 5.3MHz at -0.5dBFS		-91		dBc
		f _{IN} = 19.3MHz at -0.5dBFS, T _A ≥ +25°C		-91	-77.5	
		f _{IN} = 30.3MHz at -0.5dBFS		-88		
Intermodulation Distortion	IMD	f ₁ = 12.348685MHz at -6.5dBFS, f ₂ = 13.650845MHz at -6.5dBFS (Note 2)		91.2		dBc
Third-Order Intermodulation	IM3	(Note 2)		95.7		dBc
Aperture Jitter	t _{AJ}	(Note 2)		< 0.4		psRMS
Aperture Delay	t _{AD}	(Note 2)		1		ns
Small-Signal Bandwidth	SSBW	Input at -20dBFS (Notes 2 and 4)		100		MHz
Full-Power Bandwidth	LSBW	Input at -0.5dBFS (Notes 2 and 4)		100		MHz
Output Noise		INP = IN_N		0.45		LSBRMS
Overdrive Recovery Time	t _{OR}	R _S = 25Ω, C _S = 50pF		1		Clock cycles
COMMON-MODE OUTPUT (CMOUT)						
CMOUT Output Voltage	V _{CMOUT}			0.76		V
INTERNAL REFERENCE (REFADJ = GND, bypass REFIO to GND with 0.1μF)						
REFADJ Internal Reference Mode Enable Voltage		(Note 5)			0.1	V
REFADJ Low-Leakage Current				1.6		mA
REFIO Output Voltage	V _{REFIO}		1.18	1.24	1.30	V
Reference Temperature Coefficient	T _{CREFIO}			100		ppm/°C
EXTERNAL REFERENCE (REFADJ = AV_{DD})						
REFADJ External Reference Mode Enable Voltage		(Note 5)	AV _{DD} - 0.1V			V
REFADJ High-Leakage Current				125		μA
REFIO Input Voltage Range				1.24		V
REFIO Input Voltage Tolerance				±5		%
REFIO Input Current	I _{REFIO}			< 1		μA
CLOCK INPUT (CLK)						
Input High Voltage	V _{CLKH}		0.8 x AV _{DD}			V
Input Low Voltage	V _{CLKL}			0.2 x AV _{DD}		V
Clock Duty Cycle				50		%
Clock Duty-Cycle Tolerance				±30		%

Quad, 12-Bit, 65Mps, 1.8V ADC with Serial LVDS Outputs

ELECTRICAL CHARACTERISTICS (continued)

(AV_{DD} = 1.8V, OV_{DD} = 1.8V, CV_{DD} = 1.8V, GND = 0, external V_{REFIO} = 1.24V, REFADJ = AV_{DD}, C_{REFIO} to GND = 0.1μF, f_{CLK} = 65MHz (50% duty cycle), DT = 0, T_A = T_{MIN} to T_{MAX}, unless otherwise noted. Typical values are at T_A = +25°C.) (Note 1)

PARAMETER	SYMBOL	CONDITIONS	MIN	TYP	MAX	UNITS
Input Leakage	DI _{IN}	Input at GND			5	μA
		Input at AV _{DD}			80	
Input Capacitance	DC _{IN}			5		pF
DIGITAL INPUTS (PLL_, LVDSTEST, DT, SLVS/LVDS, PD_, PDALL, T/B)						
Input High Threshold	V _{IH}		0.8 x AV _{DD}			V
Input Low Threshold	V _{IL}				0.2 x AV _{DD}	V
Input Leakage	DI _{IN}	Input at GND			5	μA
		Input at AV _{DD}			80	
Input Capacitance	DC _{IN}			5		pF
LVDS OUTPUTS (OUT_P, OUT_N, SLVS/LVDS = 0)						
Differential Output Voltage	VOHDIFF	R _{TERM} = 100Ω	250		450	mV
Output Common-Mode Voltage	V _{OCM}	R _{TERM} = 100Ω	1.125		1.375	V
Rise Time (20% to 80%)	t _R	R _{TERM} = 100Ω, C _{LOAD} = 5pF		150		ps
Fall Time (80% to 20%)	t _F	R _{TERM} = 100Ω, C _{LOAD} = 5pF		150		ps
SLVS OUTPUTS (OUT_P, OUT_N, CLKOUTP, CLKOUTN, FRAMEP, FRAMEN), SLVS/LVDS = 1, DT = 1						
Differential Output Voltage	VOHDIFF	R _{TERM} = 100Ω		205		mV
Output Common-Mode Voltage	V _{OCM}	R _{TERM} = 100Ω		220		mV
Rise Time (20% to 80%)	t _R	R _{TERM} = 100Ω, C _{LOAD} = 5pF		120		ps
Fall Time (80% to 20%)	t _F	R _{TERM} = 100Ω, C _{LOAD} = 5pF		120		ps
POWER-DOWN						
PD Fall to Output Enable	t _{ENABLE}			132		μs
PD Rise to Output Disable	t _{DISABLE}			10		ns
POWER REQUIREMENTS						
AV _{DD} Supply Voltage	AV _{DD}		1.7	1.8	1.9	V
OV _{DD} Supply Voltage	OV _{DD}		1.7	1.8	1.9	V
CV _{DD} Supply Voltage	CV _{DD}		1.7	1.8	3.6	V

Quad, 12-Bit, 65Mps, 1.8V ADC with Serial LVDS Outputs

MAX1127

ELECTRICAL CHARACTERISTICS (continued)

(AVDD = 1.8V, OVDD = 1.8V, CVDD = 1.8V, GND = 0, external VREFIO = 1.24V, REFADJ = AVDD, CREFIO to GND = 0.1μF, fCLK = 65MHz (50% duty cycle), DT = 0, TA = TMIN to TMAX, unless otherwise noted. Typical values are at TA = +25°C.) (Note 1)

PARAMETER	SYMBOL	CONDITIONS		MIN	TYP	MAX	UNITS
AVDD Supply Current	IAVDD	fIN = 19.3MHz at -0.5dBFS	PDALL = 0, all channels active		257	295	mA
			PDALL = 0, all channels active, DT = 1		257		
			PDALL = 0, 1 channel active		82		
			PDALL = 0, PD[3:0] = 1111		23		
			PDALL = 1, global power down, PD[3:0] = 1111, no clock input		300		μA
OVDD Supply Current	IOVDD	fIN = 19.3MHz at -0.5dBFS	PDALL = 0, all channels active		56	65	mA
			PDALL = 0, all channels active, DT = 1		72		
			PDALL = 0, 1 channel active		42		
			PDALL = 0, PD[3:0] = 1111		37		
			PDALL = 1, global power-down, PD[3:0] = 1111, no clock input		375		μA
CVDD Supply Current	ICVDD	CVDD is used only to bias ESD-protection diodes on CLK input, Figure 2			0		mA
Power Dissipation	PDISS	fIN = 19.3MHz at -0.5dBFS			563	648	mW
TIMING CHARACTERISTICS (Note 6)							
Data Valid to CLKOUT Rise/Fall	tOD	fCLK = 65MHz, Figure 5 (Notes 6 and 7)		(tSAMPLE/24) - 0.15	tSAMPLE/24	(tSAMPLE/24) + 0.15	ns
CLKOUT Output Width High	tCH	Figure 5			tSAMPLE/12		ns
CLKOUT Output Width Low	tCL	Figure 5			tSAMPLE/12		ns
FRAME Rise to CLKOUT Rise	tCF	Figure 4 (Note 7)		(tSAMPLE/24) - 0.15	tSAMPLE/24	(tSAMPLE/24) + 0.15	ns
Sample CLK Rise to Frame Rise	tSF	Figure 4 (Notes 7 and 8)		(tSAMPLE/2) + 0.9	(tSAMPLE/2) + 1.3	(tSAMPLE/2) + 1.7	ns

Quad, 12-Bit, 65Mps, 1.8V ADC with Serial LVDS Outputs

ELECTRICAL CHARACTERISTICS (continued)

($V_{DD} = 1.8V$, $OV_{DD} = 1.8V$, $CV_{DD} = 1.8V$, $GND = 0$, external $V_{REFIO} = 1.24V$, $REFADJ = AV_{DD}$, C_{REFIO} to $GND = 0.1\mu F$, $f_{CLK} = 65MHz$ (50% duty cycle), $DT = 0$, $T_A = T_{MIN}$ to T_{MAX} , unless otherwise noted. Typical values are at $T_A = +25^\circ C$.) (Note 1)

PARAMETER	SYMBOL	CONDITIONS	MIN	TYP	MAX	UNITS
CHANNEL-TO-CHANNEL MATCHING						
Crosstalk		(Note 2)		-87		dB
Gain Matching		$f_{IN} = 30.3MHz$ (Note 2)		± 0.1		dB
Phase Matching		$f_{IN} = 30.3MHz$ (Note 2)		± 1		Degrees

Note 1: Specifications at $T_A \geq +25^\circ C$ are guaranteed by production testing. Specifications at $T_A < +25^\circ C$ are guaranteed by design and characterization and not subject to production testing.

Note 2: See definition in the *Parameter Definitions* section.

Note 3: The MAX1127 internally sets the common-mode voltage to 0.76V (typ) (see Figure 1). The common-mode voltage can be overdriven to between 0.55V and 0.85V.

Note 4: Limited by MAX1127EVKIT input circuitry.

Note 5: Connect REFADJ to GND directly to enable internal reference mode. Connect REFADJ to AV_{DD} directly to disable the internal bandgap reference and enable external reference mode.

Note 6: Data valid to CLKOUT rise/fall timing is measured from 50% of data output level to 50% of clock output level.

Note 7: Guaranteed by design and characterization. Not subject to production testing.

Note 8: Sample CLK rise to FRAME rise timing is measured from 50% of sample clock input level to 50% of FRAME output level.

Quad, 12-Bit, 65Mps, 1.8V ADC with Serial LVDS Outputs

MAX1127

Typical Operating Characteristics

($V_{DD} = 1.8V$, $OV_{DD} = 1.8V$, $CV_{DD} = 1.8V$, $GND = 0$, external $V_{REFIO} = 1.24V$, $REFADJ = AV_{DD}$, differential input at $-0.5dBFS$, $f_{CLK} = 65MHz$ (50% duty cycle), $DT = low$, $C_{LOAD} = 10pF$, $T_A = +25^{\circ}C$, unless otherwise noted.)

FFT PLOT
(32,768-POINT DATA RECORD)

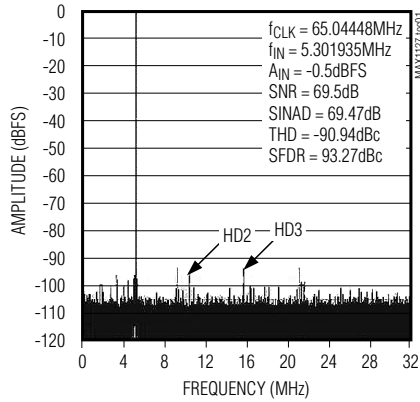

FFT PLOT
(32,768-POINT DATA RECORD)

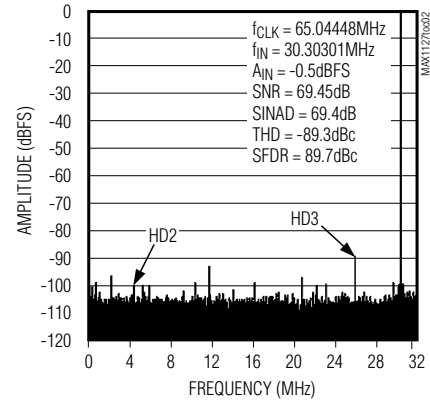

CROSSTALK
(4096-POINT DATA RECORD)

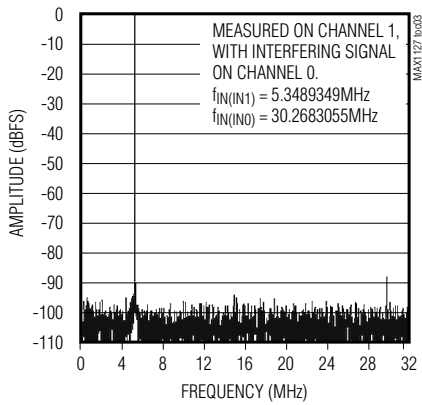

CROSSTALK
(4096-POINT DATA RECORD)

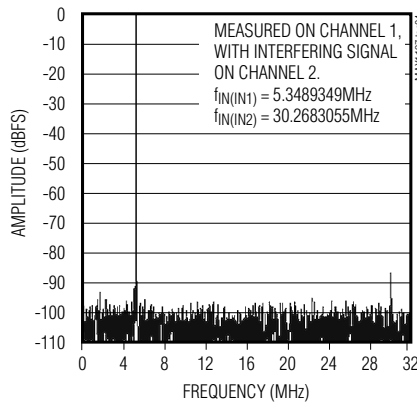

CROSSTALK
(4096-POINT DATA RECORD)

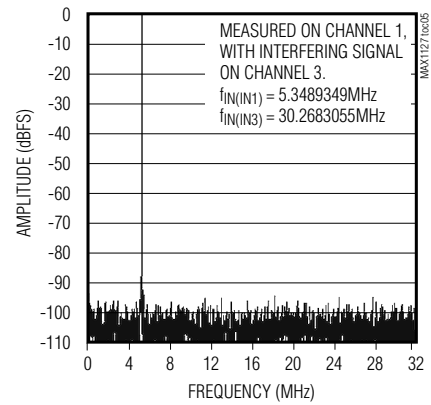

TWO-TONE INTERMODULATION DISTORTION
(32,768-POINT DATA RECORD)

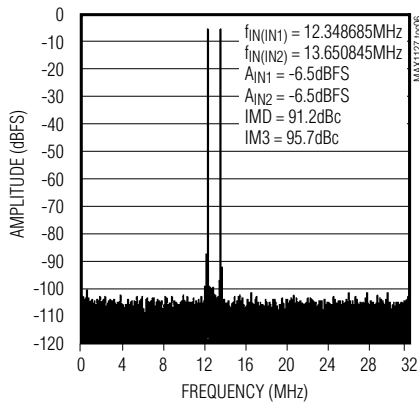

GAIN BANDWIDTH PLOT

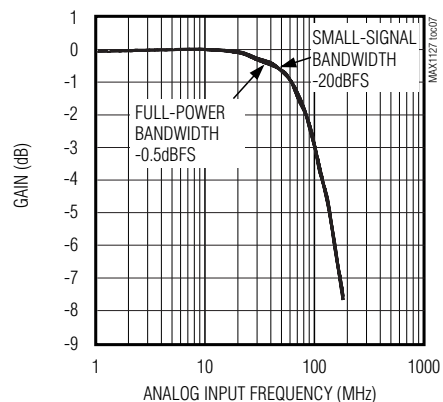

Quad, 12-Bit, 65Mps, 1.8V ADC with Serial LVDS Outputs

Typical Operating Characteristics (continued)

(AV_{DD} = 1.8V, OV_{DD} = 1.8V, CV_{DD} = 1.8V, GND = 0, external V_{REFIO} = 1.24V, REFADJ = AV_{DD}, differential input at -0.5dBFS, f_{CLK} = 65MHz (50% duty cycle), DT = low, C_{LOAD} = 10pF, T_A = +25°C, unless otherwise noted.)

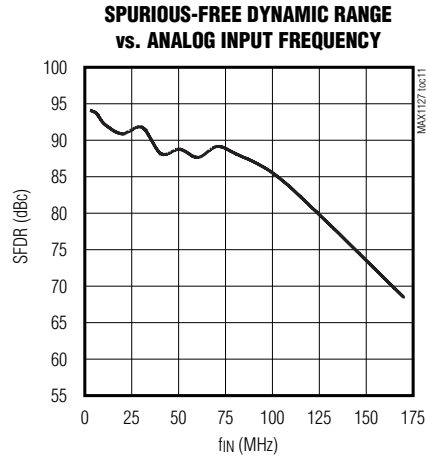
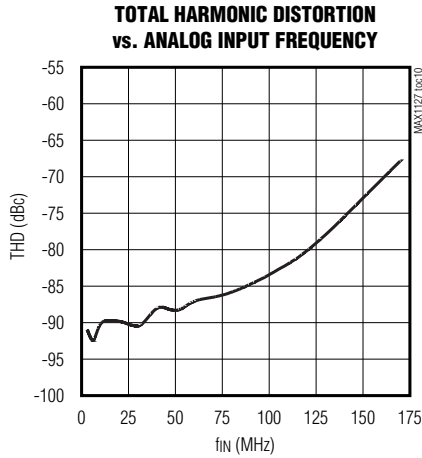
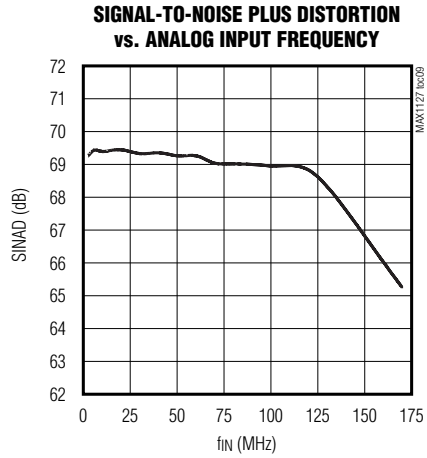
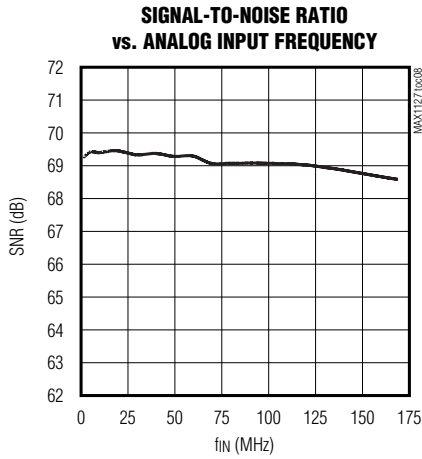

Quad, 12-Bit, 65Mps, 1.8V ADC with Serial LVDS Outputs

MAX1127

Typical Operating Characteristics (continued)

($V_{DD} = 1.8V$, $OV_{DD} = 1.8V$, $CV_{DD} = 1.8V$, $GND = 0$, external $V_{REFIO} = 1.24V$, $REFADJ = AV_{DD}$, differential input at $-0.5dBFS$, $f_{CLK} = 65MHz$ (50% duty cycle), $DT = low$, $C_{LOAD} = 10pF$, $T_A = +25^{\circ}C$, unless otherwise noted.)

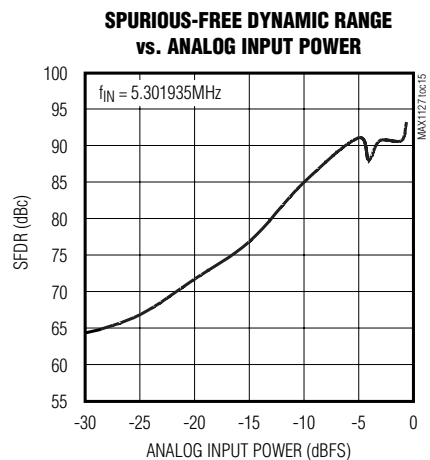
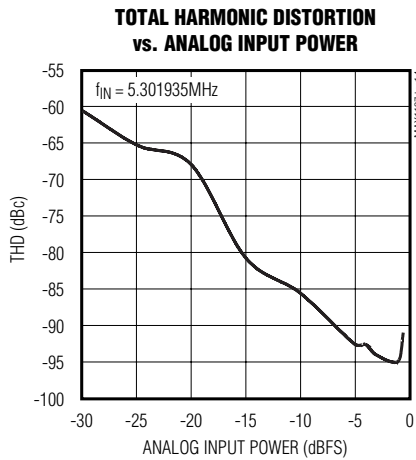
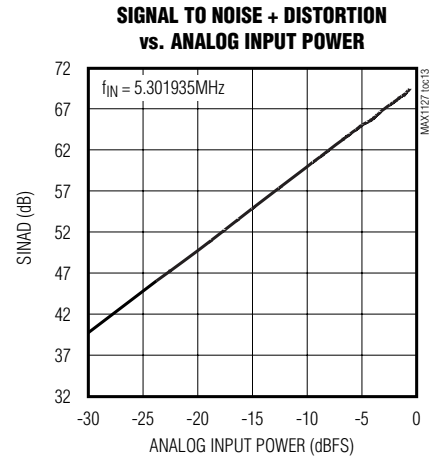
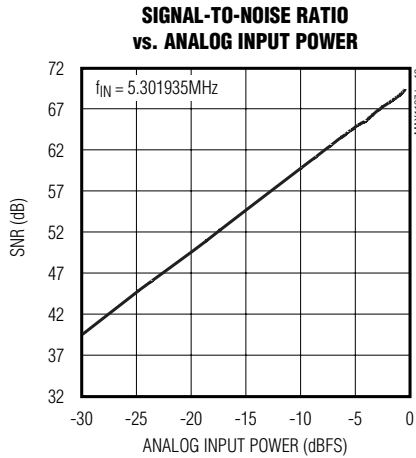

Quad, 12-Bit, 65Mps, 1.8V ADC with Serial LVDS Outputs

Typical Operating Characteristics (continued)

($AV_{DD} = 1.8V$, $OV_{DD} = 1.8V$, $CV_{DD} = 1.8V$, $GND = 0$, external $V_{REFIO} = 1.24V$, $REFADJ = AV_{DD}$, differential input at $-0.5dBFS$, $f_{CLK} = 65MHz$ (50% duty cycle), $DT = low$, $C_{LOAD} = 10pF$, $T_A = +25^{\circ}C$, unless otherwise noted.)

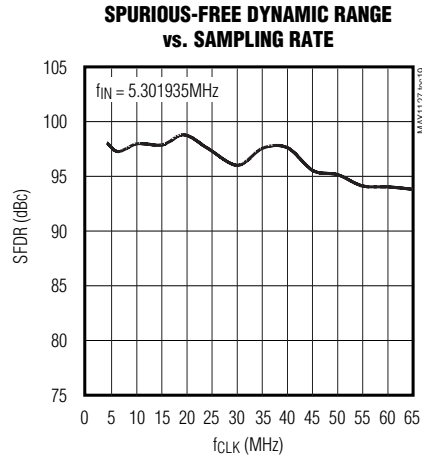
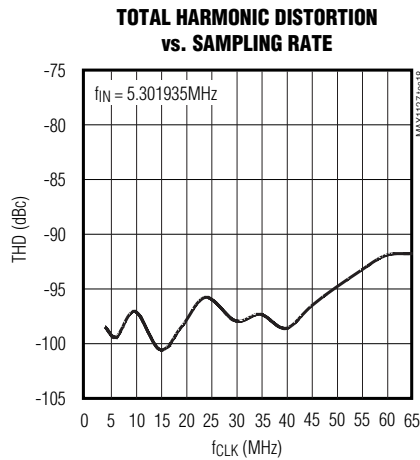
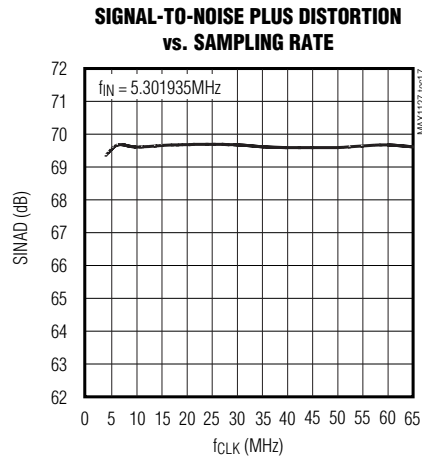
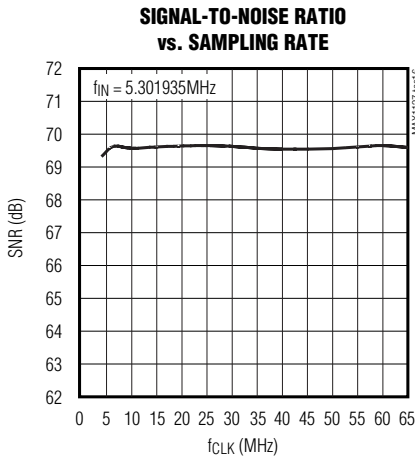

Quad, 12-Bit, 65Mps, 1.8V ADC with Serial LVDS Outputs

MAX1127

Typical Operating Characteristics (continued)

($V_{DD} = 1.8V$, $O_{VDD} = 1.8V$, $C_{VDD} = 1.8V$, $GND = 0$, external $V_{REFIO} = 1.24V$, $REFADJ = AV_{DD}$, differential input at $-0.5dBFS$, $f_{CLK} = 65MHz$ (50% duty cycle), $DT = low$, $C_{LOAD} = 10pF$, $T_A = +25^{\circ}C$, unless otherwise noted.)

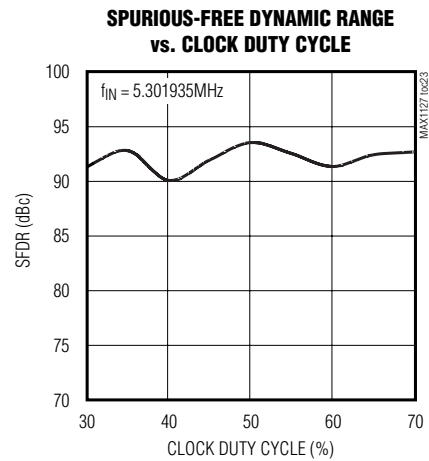
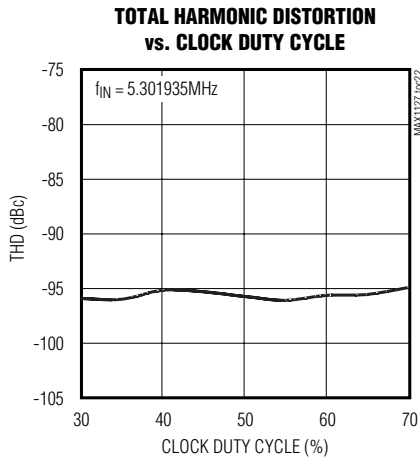
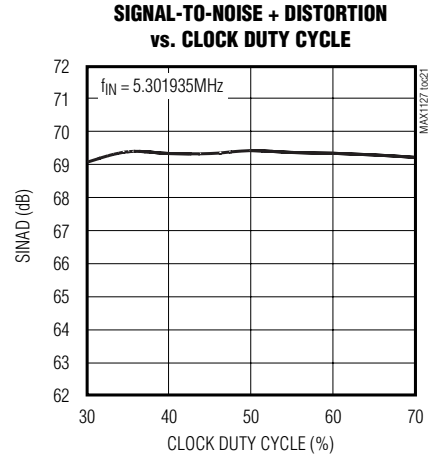
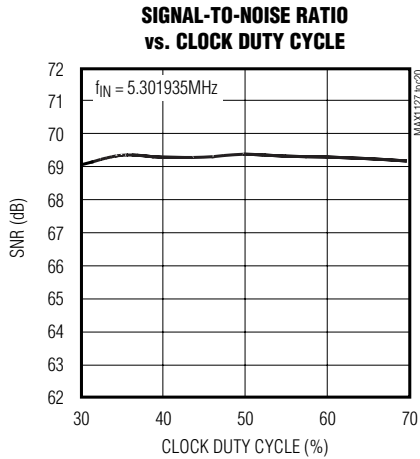

Quad, 12-Bit, 65Mps, 1.8V ADC with Serial LVDS Outputs

Typical Operating Characteristics (continued)

($V_{DD} = 1.8V$, $OV_{DD} = 1.8V$, $CV_{DD} = 1.8V$, $GND = 0$, external $V_{REFIO} = 1.24V$, $REFADJ = AV_{DD}$, differential input at $-0.5dBFS$, $f_{CLK} = 65MHz$ (50% duty cycle), $DT = low$, $C_{LOAD} = 10pF$, $T_A = +25^\circ C$, unless otherwise noted.)

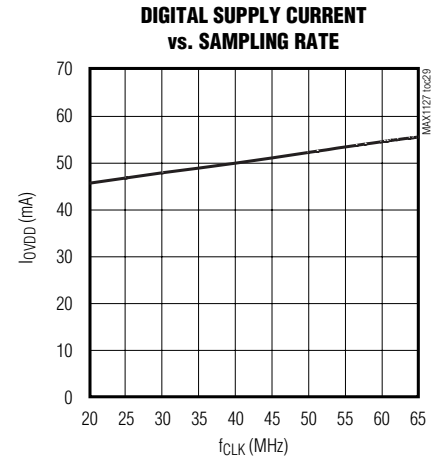
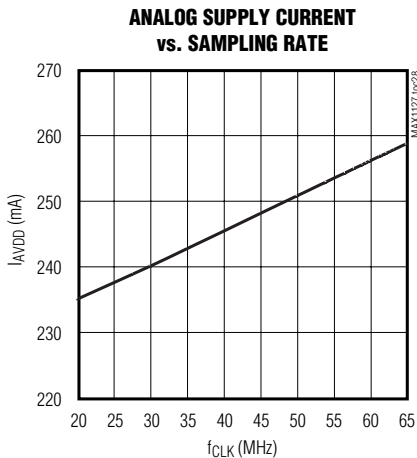
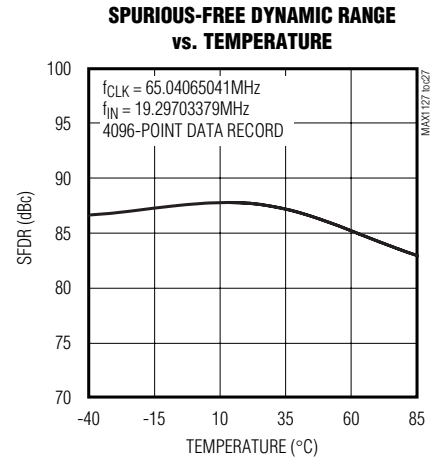
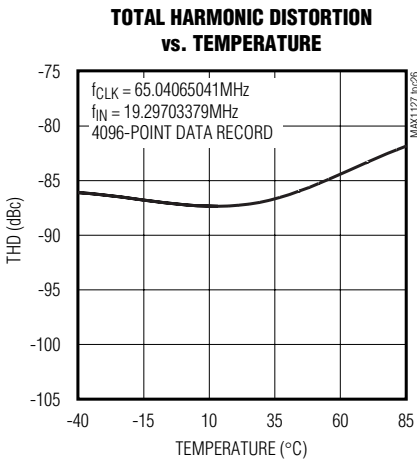
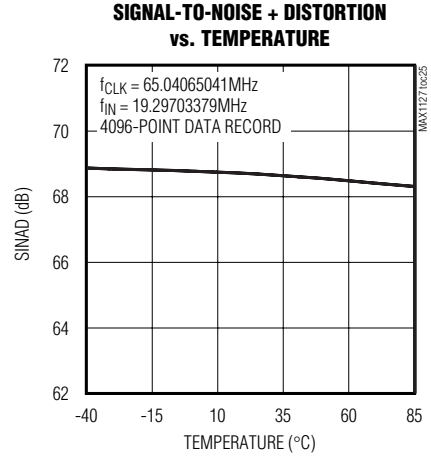
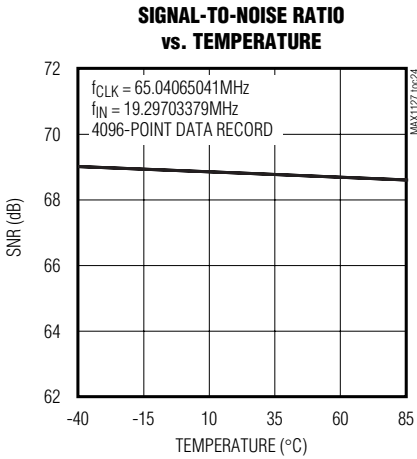

Quad, 12-Bit, 65Mps, 1.8V ADC with Serial LVDS Outputs

MAX1127

Typical Operating Characteristics (continued)

($V_{DD} = 1.8V$, $OV_{DD} = 1.8V$, $CV_{DD} = 1.8V$, $GND = 0$, external $V_{REFIO} = 1.24V$, $REFADJ = AV_{DD}$, differential input at $-0.5dBFS$, $f_{CLK} = 65MHz$ (50% duty cycle), $DT = low$, $C_{LOAD} = 10pF$, $T_A = +25^{\circ}C$, unless otherwise noted.)

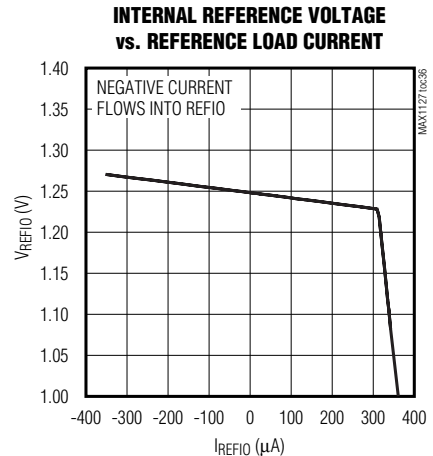
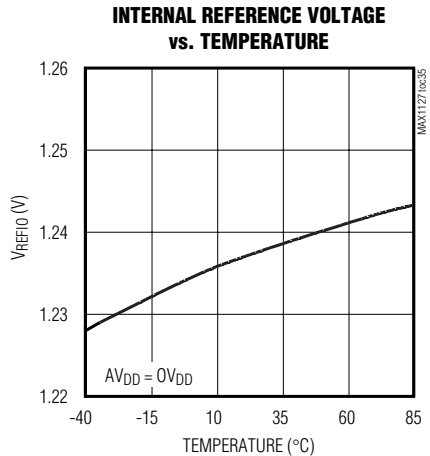
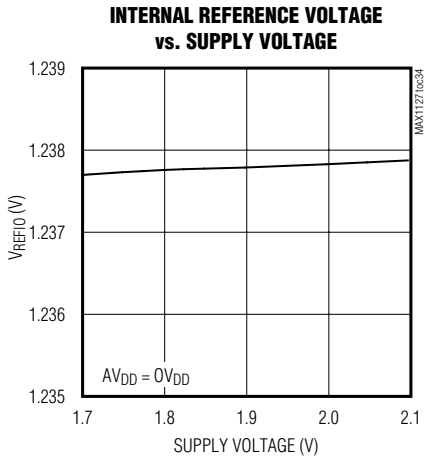
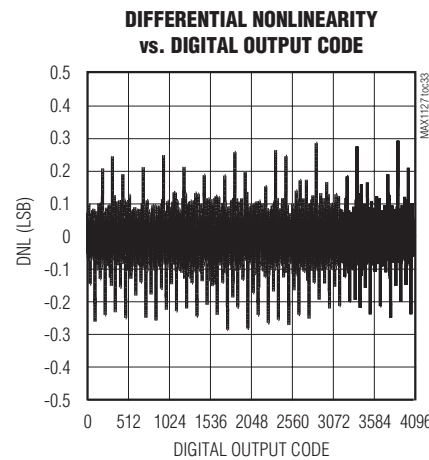
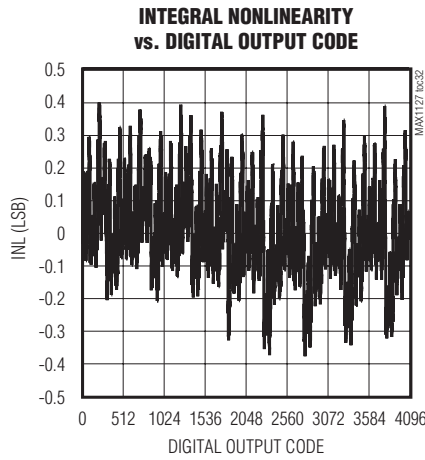
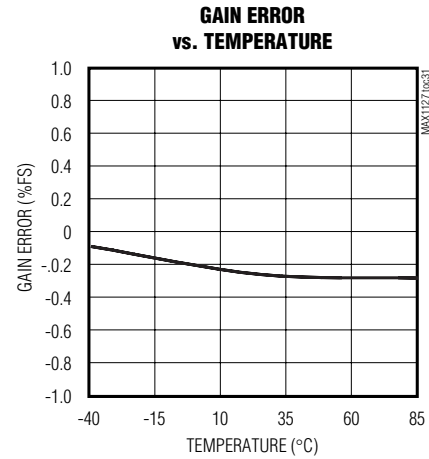
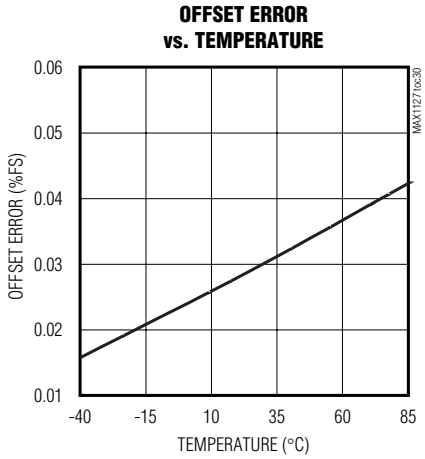

Quad, 12-Bit, 65Mps, 1.8V ADC with Serial LVDS Outputs

Typical Operating Characteristics (continued)

($AV_{DD} = 1.8V$, $OV_{DD} = 1.8V$, $CV_{DD} = 1.8V$, $GND = 0$, external $V_{REFIO} = 1.24V$, $REFADJ = AV_{DD}$, differential input at $-0.5dBFS$, $f_{CLK} = 65MHz$ (50% duty cycle), $DT = low$, $C_{LOAD} = 10pF$, $T_A = +25^{\circ}C$, unless otherwise noted.)

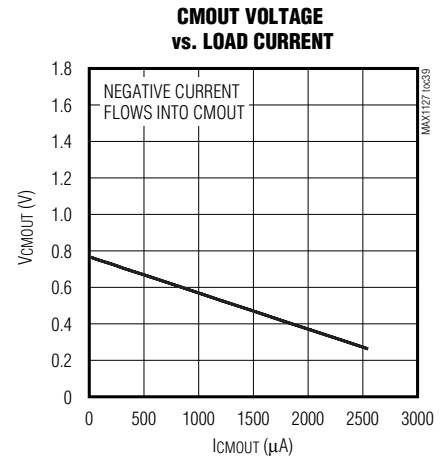
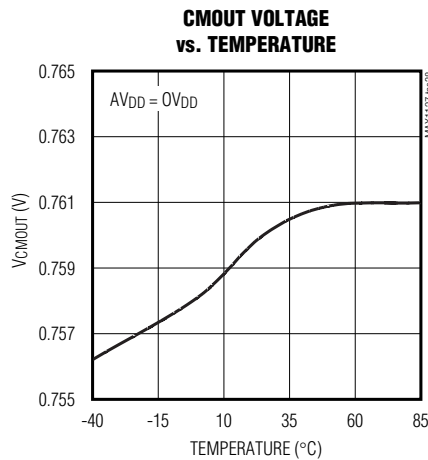
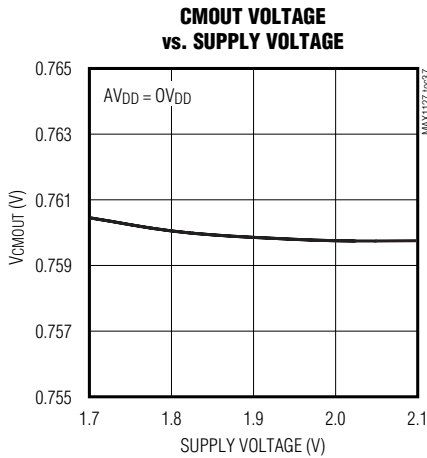

Pin Description

PIN	NAME	FUNCTION
1, 4, 7, 11, 14, 17, 22, 24, 65, 68	GND	Ground. Connect all GND pins to the same potential.
2	IN0P	Channel 0 Positive Analog Input
3	IN0N	Channel 0 Negative Analog Input
5	IN1P	Channel 1 Positive Analog Input
6	IN1N	Channel 1 Negative Analog Input
8, 9, 10, 18, 20, 25, 26, 27, 58–62	AV _{DD}	Analog Power Input. Connect AV _{DD} to a 1.7V to 1.9V power supply. Bypass each AV _{DD} to GND with a 0.1µF capacitor as close to the device as possible. Bypass the AV _{DD} power plane to the GND ground plane with a bulk ≥ 2.2µF capacitor as close to the device as possible. Connect all AV _{DD} pins to the same potential.
12	IN2P	Channel 2 Positive Analog Input
13	IN2N	Channel 2 Negative Analog Input
15	IN3P	Channel 3 Positive Analog Input
16	IN3N	Channel 3 Negative Analog Input
19	CMOUT	Common-Mode Reference Voltage Output. Bypass CMOUT to GND with a 0.1µF capacitor
21	CV _{DD}	Clock Power Input. Connect CV _{DD} to a 1.7V to 3.6V supply. Bypass CV _{DD} to GND with a 0.1µF capacitor in parallel with a ≥ 2.2µF capacitor. Install the bypass capacitors as close to the device as possible.
23	CLK	Single-Ended CMOS Clock Input
28	DT	Double Termination Select Input. Drive DT high to select the internal 100Ω termination between the differential output pairs. Drive DT low to select no internal output termination.

Quad, 12-Bit, 65MSPS, 1.8V ADC with Serial LVDS Outputs

Pin Description (continued)

MAX1127

PIN	NAME	FUNCTION
29	SLVS/LVDS	Differential Output Signal Format Select Input. Drive SLVS/LVDS high to select SLVS outputs. Drive SLVS/LVDS low to select LVDS outputs.
30	PLL0	PLL Control Input 0. PLL0 is reserved for factory testing only and must always be connected to GND.
31	PLL1	PLL Control Input 1. See Table 1 for details.
32	PLL2	PLL Control Input 2. See Table 1 for details.
33	PLL3	PLL Control Input 3. See Table 1 for details.
34, 37, 40, 43, 46, 49, 52	OVDD	Output-Driver Power Input. Connect OVDD to a 1.7V to 1.9V power supply. Bypass each OVDD to GND with a 0.1µF capacitor as close to the device as possible. Bypass the OVDD power plane to the GND ground plane with a bulk ≥ 2.2µF capacitor as close to the device as possible. Connect all OVDD pins to the same potential.
35	OUT3N	Channel 3 Negative LVDS/SLVS Output
36	OUT3P	Channel 3 Positive LVDS/SLVS Output
38	OUT2N	Channel 2 Negative LVDS/SLVS Output
39	OUT2P	Channel 2 Positive LVDS/SLVS Output
41	FRAMEN	Negative Frame Alignment LVDS/SLVS Output. A rising edge on the differential FRAME output aligns to a valid D0 in the output data stream.
42	FRAMEP	Positive Frame Alignment LVDS/SLVS Output. A rising edge on the differential FRAME output aligns to a valid D0 in the output data stream.
44	CLKOUTN	Negative LVDS/SLVS Serial Clock Output
45	CLKOUTP	Positive LVDS/SLVS Serial Clock Output
47	OUT1N	Channel 1 Negative LVDS/SLVS Output
48	OUT1P	Channel 1 Positive LVDS/SLVS Output
50	OUT0N	Channel 0 Negative LVDS/SLVS Output
51	OUT0P	Channel 0 Positive LVDS/SLVS Output
53	PD0	Channel 0 Power-Down Input. Drive PD0 high to power-down channel 0. Drive PD0 low for normal operation.
54	PD1	Channel 1 Power-Down Input. Drive PD1 high to power-down channel 1. Drive PD1 low for normal operation.
55	PD2	Channel 2 Power-Down Input. Drive PD2 high to power-down channel 2. Drive PD2 low for normal operation.
56	PD3	Channel 3 Power-Down Input. Drive PD3 high to power-down channel 3. Drive PD3 low for normal operation.
57	PDALL	Global Power-Down Input. Drive PDALL high to power-down all channels and reference. Drive PDALL low for normal operation.
63	T̄/B	Output Format Select Input. Drive T̄/B high to select binary output format. Drive T̄/B low to select two's complement output format.
64	LVDSTEST	LVDS Test Pattern Enable Input. Drive LVDSTEST high to enable the output test pattern (000010111101 MSB→LSB). As with the analog conversion results, the test pattern data is output LSB first. Drive LVDSTEST low for normal operation.

Quad, 12-Bit, 65Mps, 1.8V ADC with Serial LVDS Outputs

Pin Description (continued)

PIN	NAME	FUNCTION
66	REFIO	Reference Input/Output. For internal reference operation (REFADJ = GND), the reference output voltage is 1.24V. For external reference operation (REFADJ = AV _{DD}), apply a stable reference voltage at REFIO. Bypass to GND with a 0.1μF capacitor.
67	REFADJ	Internal/External Reference Mode Select Input. For internal reference mode, connect REFADJ directly to GND. For external reference mode, connect REFADJ directly to AV _{DD} . For reference-adjust mode, see the <i>Full-Scale Range Adjustments Using the Internal Reference</i> section.
—	EP	Exposed Paddle. EP is internally connected to GND. Externally connect EP to GND to achieve specified performance.

Functional Diagram

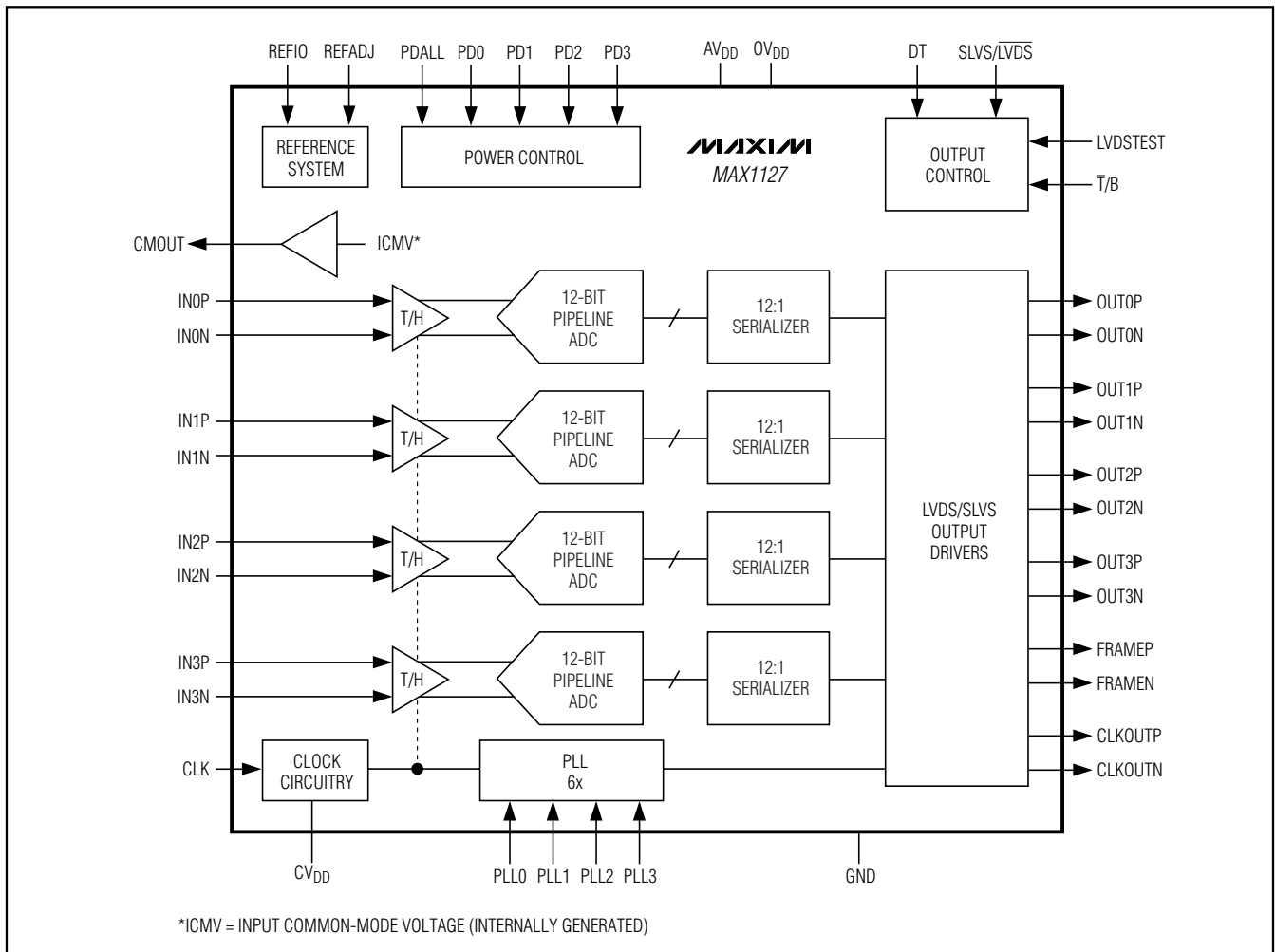

Quad, 12-Bit, 65Mps, 1.8V ADC with Serial LVDS Outputs

Detailed Description

The MAX1127 ADC features fully differential inputs, a pipelined architecture, and digital error correction for high-speed signal conversion. The ADC pipeline architecture moves the samples taken at the inputs through the pipeline stages every half clock cycle. The converted digital results are serialized and sent through the LVDS/SLVS output drivers. The total latency from input to output is 6.5 input clock cycles.

The MAX1127 offers four separate fully differential channels with synchronized inputs and outputs. Configure the outputs for binary or two's complement with the \bar{T}/B digital input. Power-down each channel individually or globally to minimize power consumption.

Input Circuit

Figure 1 displays a simplified functional diagram of the input T/H circuits. In track mode, switches S1, S2a, S2b, S4a, S4b, S5a, and S5b are closed. The fully differential circuits sample the input signals onto the two capacitors (C2a and C2b) through switches S4a and S4b. S2a and S2b set the common mode for the operational transcon-

ductance amplifier (OTA), and open simultaneously with S1, sampling the input waveform. Switches S4a, S4b, S5a, and S5b are then opened before switches S3a and S3b connect capacitors C1a and C1b to the output of the amplifier and switch S4c is closed. The resulting differential voltages are held on capacitors C2a and C2b. The amplifiers charge capacitors C1a and C1b to the same values originally held on C2a and C2b. These values are then presented to the first-stage quantizers and isolate the pipelines from the fast-changing inputs. Analog inputs IN_P to IN_N are driven differentially. For differential inputs, balance the input impedance of IN_P and IN_N for optimum performance.

The MAX1127 analog inputs are self-biased at a common-mode voltage of 0.76V (typ) and allow a differential input voltage swing of 1.4V_{p-p}. The common-mode voltage can be overdriven to between 0.55V to 0.85V. Drive the analog inputs of the MAX1127 in AC-coupled configuration to achieve best dynamic performance. See the *Using Transformer Coupling* section for a detailed discussion of this configuration.

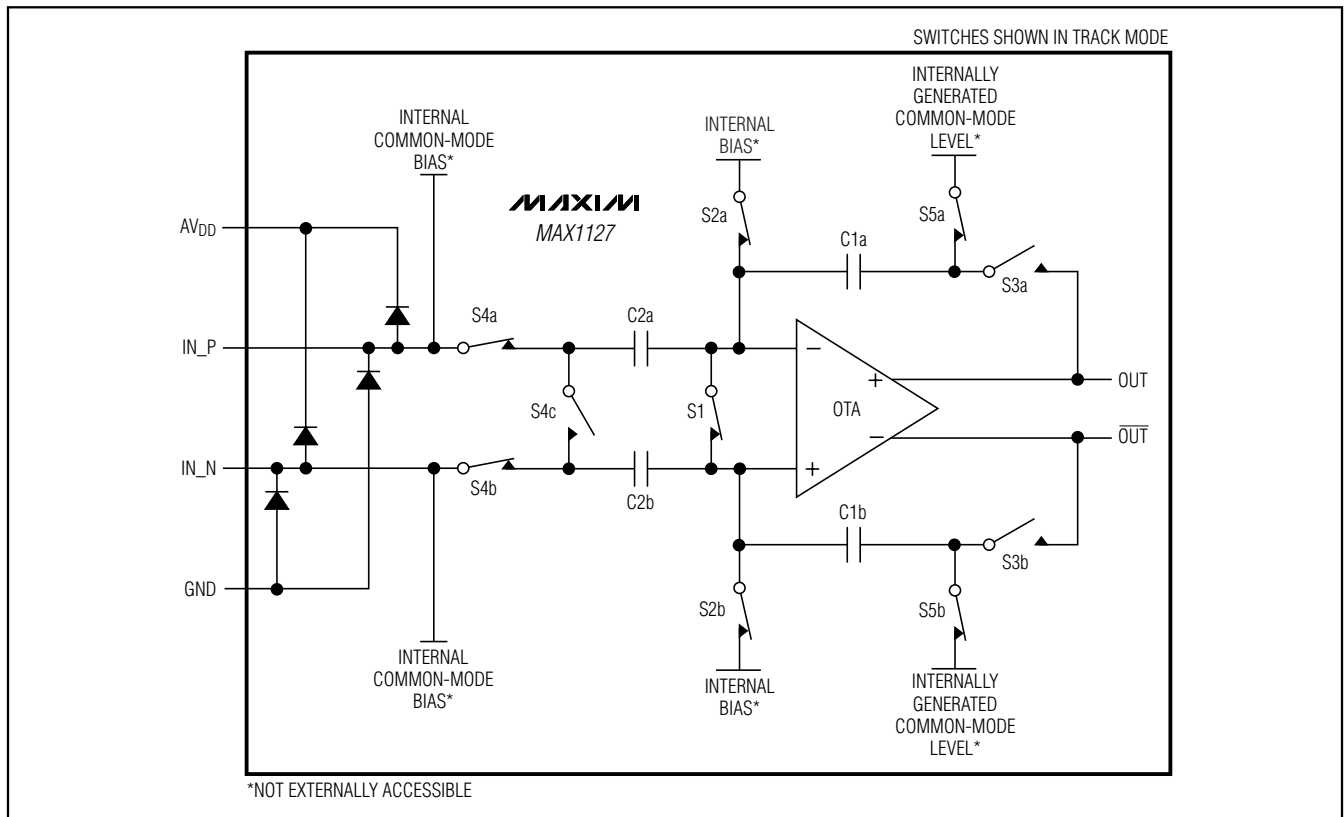

Figure 1. Internal Input Circuitry

Quad, 12-Bit, 65Mps, 1.8V ADC with Serial LVDS Outputs

Reference Configurations (REFIO and REFADJ)

The MAX1127 provides an internal 1.24V bandgap reference or can be driven with an external reference voltage. The MAX1127 full-scale analog differential input range is \pm FSR. Full-scale range (FSR) is given by the following equation:

$$\text{FSR} = 700\text{mV} \times \frac{V_{\text{REFIO}}}{1.24\text{V}}$$

where V_{REFIO} is the voltage at REFIO, generated internally or externally. For a $V_{\text{REFIO}} = 1.24\text{V}$, the full-scale input range is $\pm 700\text{mV}$ (1.4VP-P).

Internal Reference Mode

Connect REFADJ to GND to use the internal bandgap reference directly. The internal bandgap reference generates REFIO to be 1.24V with a 100ppm/°C temperature coefficient in internal reference mode. Connect an external $\geq 0.1\mu\text{F}$ bypass capacitor from REFIO to GND for stability. REFIO sources up to 200 μA and sinks up to 200 μA for external circuits, and REFIO has a load regulation of 83mV/mA. The global power-down input (PDALL) enables and disables the reference circuit. REFIO has $> 1\text{M}\Omega$ resistance to GND when the MAX1127 is in power-down mode. The internal reference circuit requires 132 μs to power-up and settle when power is applied to the MAX1127 or when PDALL transitions from high to low.

To compensate for gain errors or to decrease or increase the ADC's full-scale range (FSR), add an external resistor between REFADJ and GND or REFADJ and REFIO. This adjusts the internal reference value of the MAX1127 by up to $\pm 5\%$ of its nominal value. See the *Full-Scale Range Adjustments Using the Internal Reference* section.

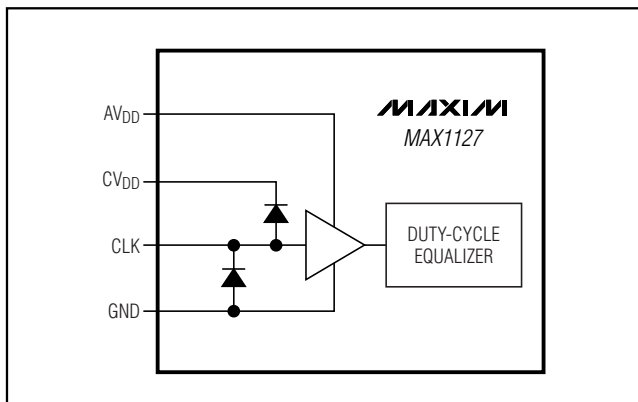

Figure 2. Clock Input Circuitry

External Reference Mode

The external reference mode allows for more control over the MAX1127 reference voltage and allows multiple converters to use a common reference. Connect REFADJ to AVDD to disable the internal reference and enter external reference mode. Apply a stable 1.18V to 1.30V source at REFIO. Bypass REFIO to GND with a 0.1 μF capacitor. The REFIO input impedance is $> 1\text{M}\Omega$.

Clock Input (CLK)

The MAX1127 accepts a CMOS-compatible clock signal with a wide 20% to 80% input-clock duty cycle. Drive CLK with an external single-ended clock signal. Figure 2 shows the simplified clock input diagram.

Low clock jitter is required for the specified SNR performance of the MAX1127. Analog input sampling occurs on the rising edge of CLK, requiring this edge to provide the lowest possible jitter. Jitter limits the maximum SNR performance of any ADC according to the following relationship:

$$\text{SNR} = 20 \times \log \left(\frac{1}{2 \times \pi \times f_{\text{IN}} \times t_{\text{J}}} \right)$$

where f_{IN} represents the analog input frequency and t_{J} is the total system clock jitter. Clock jitter is especially critical for undersampling applications. For example, assuming that clock jitter is the only noise source, to obtain the specified 69.4dB of SNR with an input frequency of 30.3MHz, the system must have less than 1.8ps of clock jitter. In actuality, there are other noise sources, such as thermal noise and quantization noise, that contribute to the system noise requiring the clock jitter to be less than 0.5ps to obtain the specified 69.4dB of SNR at 30.3MHz.

Table 1. PLL1, PLL2, and PLL3 Configuration

PLL1	PLL2	PLL3	CLOCK INPUT RANGE (MHz)	
			MIN	MAX
0	0	0	45.0	65.0
0	0	1	32.5	45.0
0	1	0	22.5	32.5
0	1	1	16.3	22.5
1	0	0	11.3	16.3
1	0	1	8.1	11.3
1	1	0	5.6	8.1
1	1	1	4.0	5.6

*PLL0 is reserved for factory testing and must always be connected to GND.

Quad, 12-Bit, 65Mps, 1.8V ADC with Serial LVDS Outputs

MAX1127

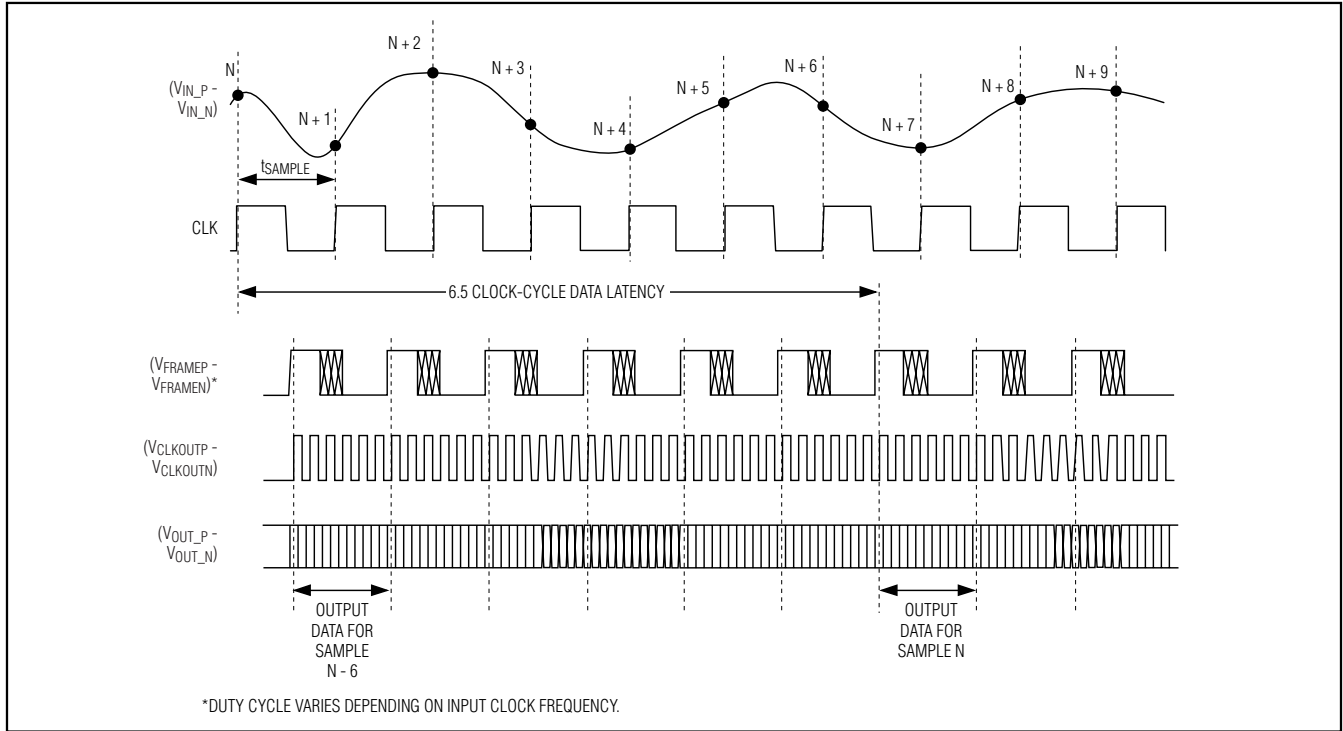

Figure 3. Global Timing Diagram

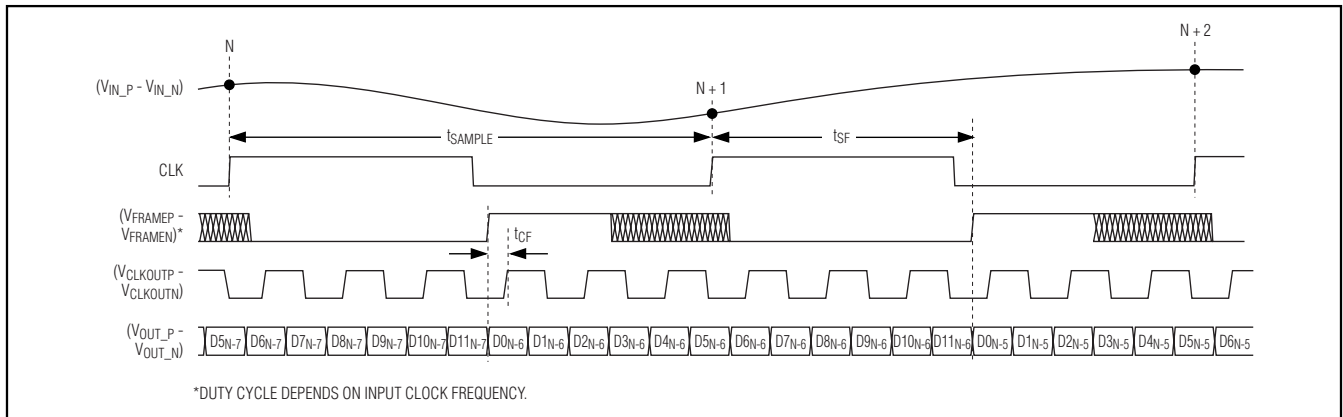

Figure 4. Detailed Two-Conversion Timing Diagram

The MAX1127 features a PLL that generates an output clock signal with six times the frequency of the input clock. The output clock signal is used to clock data out of the MAX1127 (see the *System Timing Requirements* section). Set the PLL1, PLL2, and PLL3 bits according to the input clock range provided in Table 1. PLL0 is reserved for factory testing and must always be connected to GND.

System Timing Requirements

Figure 3 shows the relationship between the analog inputs, input clock, frame alignment output, serial clock output, and serial data output. The differential analog input (IN_P and IN_N) is sampled on the rising edge of the CLK signal and the resulting data appears at the digital outputs 6.5 clock cycles later. Figure 4 provides a detailed, two-conversion timing diagram of the relationship between the inputs and the outputs.

Quad, 12-Bit, 65Mps, 1.8V ADC with Serial LVDS Outputs

Clock Output (CLKOUTP, CLKOUTN)

The MAX1127 provides a differential clock output that consists of CLKOUTP and CLKOUTN. As shown in Figure 4, the serial output data is clocked out of the MAX1127 on both edges of the clock output. The frequency of the output clock is 6 times the frequency of CLK.

Frame Alignment Output (FRAMEP, FRAMEN)

The MAX1127 provides a differential frame alignment signal that consists of FRAMEP and FRAMEN. As shown in Figure 4, the rising edge of the frame alignment signal corresponds to the first bit (D0) of the 12-bit serial data stream. The frequency of the frame alignment signal is identical to the frequency of the sample clock.

Serial Output Data (OUT_P, OUT_N)

The MAX1127 provides its conversion results through individual differential outputs consisting of OUT_P and OUT_N. The results are valid 6.5 input clock cycles after the sample is taken. As shown in Figure 3, the output data is clocked out on both edges of the output clock, LSB (D0) first. Figure 5 provides the detailed serial output timing diagram.

Output Data Format (\bar{T}/B), Transfer Functions

The MAX1127 output data format is either offset binary or two's complement, depending on the logic input \bar{T}/B . With \bar{T}/B low, the output data format is two's complement. With \bar{T}/B high, the output data format is offset binary. The following equations, Table 2, Figure 6, and Figure 7 define the relationship between the digital output and the analog input. For two's complement ($\bar{T}/B = 0$):

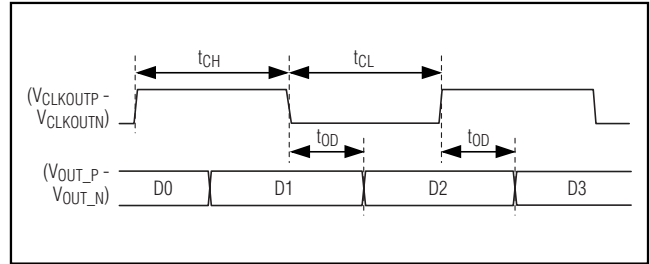

Figure 5. Serialized Output Detailed Timing Diagram

$$V_{IN_P} - V_{IN_N} = FSR \times 2 \times \frac{CODE_{10}}{4096}$$

and for offset binary ($\bar{T}/B = 1$):

$$V_{IN_P} - V_{IN_N} = FSR \times 2 \times \frac{CODE_{10} - 2048}{4096}$$

where $CODE_{10}$ is the decimal equivalent of the digital output code as shown in Table 2. FSR is the full-scale range as shown in Figures 6 and 7.

Keep the capacitive load on the MAX1127 digital outputs as low as possible.

LVDS and SLVS Signals (SLVS/LVDS)

Drive SLVS/LVDS low for LVDS or drive SLVS/LVDS high for scalable low-voltage signaling (SLVS) levels at the MAX1127 outputs (OUT_P, OUT_N, CLKOUT_P, CLKOUT_N, FRAMEP_, and FRAMEN_). For SLVS levels, enable double termination by driving OT high. See the *Electrical Characteristics* table for LVDS and SLVS output voltage levels.

Table 2. Output Code Table ($V_{REFIO} = 1.24V$)

TWO'S COMPLEMENT DIGITAL OUTPUT CODE ($\bar{T}/B = 0$)			OFFSET BINARY DIGITAL OUTPUT CODE ($\bar{T}/B = 1$)			$V_{IN_P} - V_{IN_N}$ (mV) ($V_{REFIO} = 1.24V$)
BINARY D11 → D0	HEXADECIMAL EQUIVALENT OF D11 → D0	DECIMAL EQUIVALENT OF D11 → D0	BINARY D11 → D0	HEXADECIMAL EQUIVALENT OF D11 → D0	DECIMAL EQUIVALENT OF D11 → D0	
0111 1111 1111	0x7FF	+2047	1111 1111 1111	0xFFF	+4095	+699.66
0111 1111 1110	0x7FE	+2046	1111 1111 1110	0xFFE	+4094	+699.32
0000 0000 0001	0x001	+1	1000 0000 0001	0x801	+2049	+0.34
0000 0000 0000	0x000	0	1000 0000 0000	0x800	+2048	0
1111 1111 1111	0xFFF	-1	0111 1111 1111	0x7FF	+2047	-0.34
1000 0000 0001	0x801	-2047	0000 0000 0001	0x001	+1	-699.66
1000 0000 0000	0x800	-2048	0000 0000 0000	0x000	0	-700.00

Quad, 12-Bit, 65MSPS, 1.8V ADC with Serial LVDS Outputs

MAX1127

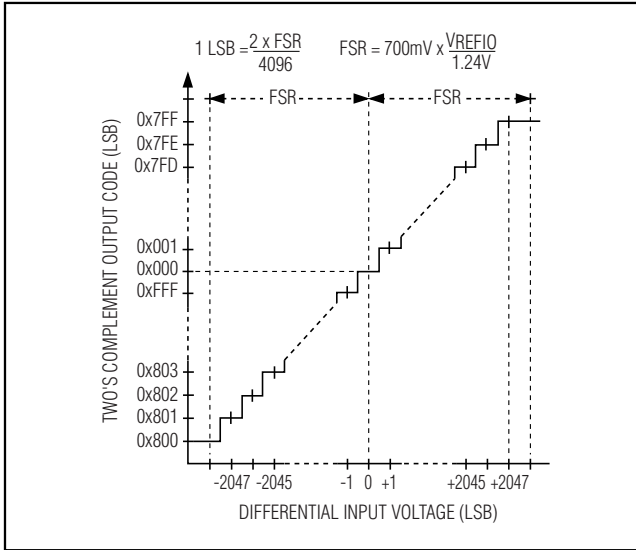

Figure 6. Bipolar Transfer Function with Two's Complement Output Code ($\bar{T}/B = 0$)

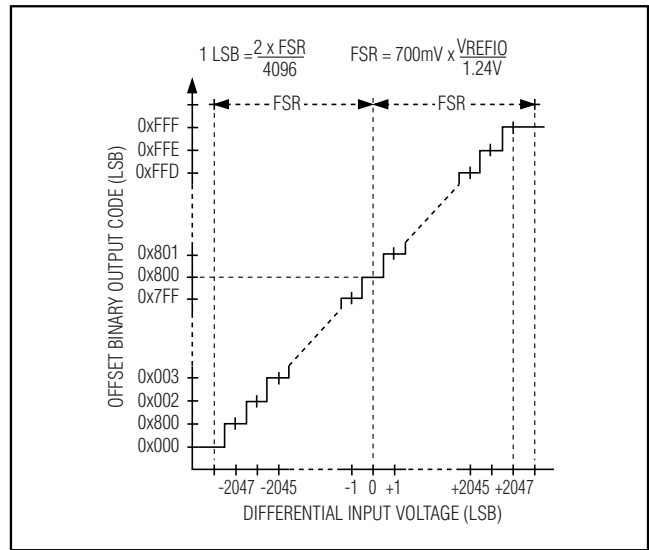

Figure 7. Bipolar Transfer Function with Offset Binary Output Code ($\bar{T}/B = 1$)

LVDS Test Pattern (LVDSTEST)

Drive LVDSTEST high to enable the output test pattern on all LVDS or SLVS output channels. The output test pattern is 0000 1011 1101 MSB→LSB. As with the analog conversion results, the test pattern data is output LSB first. Drive LVDSTEST low for normal operation (test pattern disabled).

Common-Mode Output Voltage (CMOUT)

CMOUT provides a common-mode reference for DC-coupled analog inputs. If the input is DC-coupled, match the output common-mode voltage of the circuit driving the MAX1127 to the output voltage at VCMOUT to within $\pm 50\text{mV}$. It is recommended that the output common-mode voltage of the driving circuit be derived from CMOUT.

Double Termination (DT)

As shown in Figure 8, the MAX1127 offers an optional, internal 100Ω termination between the differential output pairs (OUT_P and OUT_N, CLKOUTP and CLKOUTN, FRAMEP and FRAMEN). In addition to the termination at the end of the line, a second termination directly at the outputs helps eliminate unwanted reflections down the line. This feature is useful in applications where trace lengths are long ($> 5\text{in}$) or with mismatched impedance. Drive DT high to select double termination, or drive DT low to disconnect the internal termination resistor (single termination). Selecting double termination increases the OV_{DD} supply current (see the *Electrical Characteristics* table).

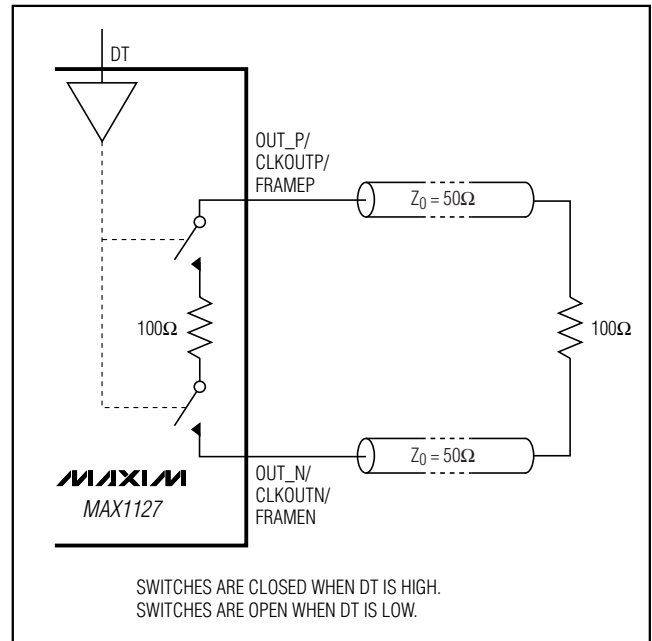

Figure 8. Double Termination

Power-Down Modes

The MAX1127 offers two types of power-down inputs, PD0–PD3 and PDALL. The power-down modes allow the MAX1127 to use power efficiently by transitioning to a low-power state when conversions are not required.

Quad, 12-Bit, 65Mps, 1.8V ADC with Serial LVDS Outputs

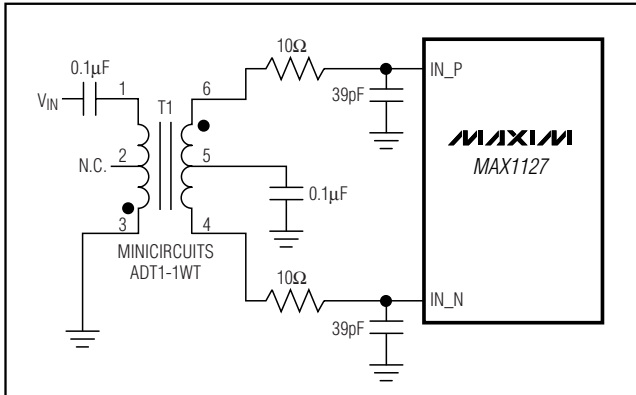

Figure 10. Transformer-Coupled Input Drive

Using Transformer Coupling

An RF transformer (Figure 10) provides an excellent solution to convert a single-ended input source signal to a fully differential signal, required by the MAX1127 for optimum performance. The MAX1127 input common-mode voltage is internally biased to 0.76V (typ) with $f_{CLK} = 65\text{MHz}$. Although a 1:1 transformer is shown, a step-up transformer can be selected to reduce the drive requirements. A reduced signal swing from the input driver, such as an op amp, can also improve the overall distortion.

Grounding, Bypassing, and Board Layout

The MAX1127 requires high-speed board layout design techniques. Refer to the MAX1127 EV kit data sheet for a board layout reference. Locate all bypass capacitors as close to the device as possible, preferably on the same side as the ADC, using surface-mount devices for minimum inductance. Bypass AV_{DD} to GND with a $0.1\mu\text{F}$ ceramic capacitor in parallel with a $\geq 2.2\mu\text{F}$ ceramic capacitor. Bypass OV_{DD} to GND with a $0.1\mu\text{F}$ ceramic capacitor in parallel with a $\geq 2.2\mu\text{F}$ ceramic capacitor. Bypass CV_{DD} to GND with a $0.1\mu\text{F}$ ceramic capacitor in parallel with a $\geq 2.2\mu\text{F}$ ceramic capacitor.

Multilayer boards with ample ground and power planes produce the highest level of signal integrity. Connect MAX1127 ground pins and the exposed backside paddle to the same ground plane. The MAX1127 relies on the exposed backside paddle connection for a low-

inductance ground connection. Isolate the ground plane from any noisy digital system ground planes.

Route high-speed digital signal traces away from the sensitive analog traces. Keep all signal lines short and free of 90° turns.

Ensure that the differential analog input network layout is symmetric and that all parasitics are balanced equally. Refer to the MAX1127 EV kit data sheet for an example of symmetric input layout.

Parameter Definitions

Integral Nonlinearity (INL)

Integral nonlinearity is the deviation of the values on an actual transfer function from a straight line. For the MAX1127, this straight line is between the end points of the transfer function, once offset and gain errors have been nullified. INL deviations are measured at every step and the worst-case deviation is reported in the *Electrical Characteristics* table.

Differential Nonlinearity (DNL)

Differential nonlinearity is the difference between an actual step width and the ideal value of 1 LSB. A DNL error specification of less than 1 LSB guarantees no missing codes and a monotonic transfer function. For the MAX1127, DNL deviations are measured at every step and the worst-case deviation is reported in the *Electrical Characteristics* table.

Offset Error

Offset error is a figure of merit that indicates how well the actual transfer function matches the ideal transfer function at a single point. For the MAX1127, the ideal midscale digital output transition occurs when there is $-1/2$ LSB across the analog inputs (Figures 6 and 7). Bipolar offset error is the amount of deviation between the measured midscale transition point and the ideal midscale transition point.

Gain Error

Gain error is a figure of merit that indicates how well the slope of the actual transfer function matches the slope of the ideal transfer function. For the MAX1127, the gain error is the difference of the measured full-scale and zero-scale transition points minus the difference of the ideal full-scale and zero-scale transition points.

Quad, 12-Bit, 65Mps, 1.8V ADC with Serial LVDS Outputs

For the bipolar devices (MAX1127), the full-scale transition point is from 0x7FE to 0x7FF for two's complement output format (0xFFE to 0xFFF for offset binary) and the zero-scale transition point is from 0x800 to 0x801 for two's complement (0x000 to 0x001 for offset binary).

Crosstalk

Crosstalk indicates how well each analog input is isolated from the others. For the MAX1127, a 5.3MHz, -0.5dBFS analog signal is applied to one channel while a 30.3MHz, -0.5dBFS analog signal is applied to all other channels. An FFT is taken on the channel with the 5.3MHz analog signal. From this FFT, the crosstalk is measured as the difference in the 5.3MHz and 30.3MHz amplitudes.

Aperture Delay

Aperture delay (t_{AD}) is the time defined between the rising edge of the sampling clock and the instant when an actual sample is taken. See Figure 11.

Aperture Jitter

Aperture jitter (t_{AJ}) is the sample-to-sample variation in the aperture delay. See Figure 11.

Signal-to-Noise Ratio (SNR)

For a waveform perfectly reconstructed from digital samples, the theoretical maximum SNR is the ratio of the full-scale analog input (RMS value) to the RMS quantization error (residual error). The ideal, theoretical minimum analog-to-digital noise is caused by quantization error only and results directly from the ADC's resolution (N bits):

$$\text{SNR}_{\text{dB}[\text{max}]} = 6.02\text{dB} \times N \times 1.76\text{dB}$$

In reality, there are other noise sources besides quantization noise: thermal noise, reference noise, clock jitter, etc.

For the MAX1127, SNR is computed by taking the ratio of the RMS signal to the RMS noise. RMS noise includes all spectral components to the Nyquist frequency excluding the fundamental, the first six harmonics (HD2–HD7), and the DC offset.

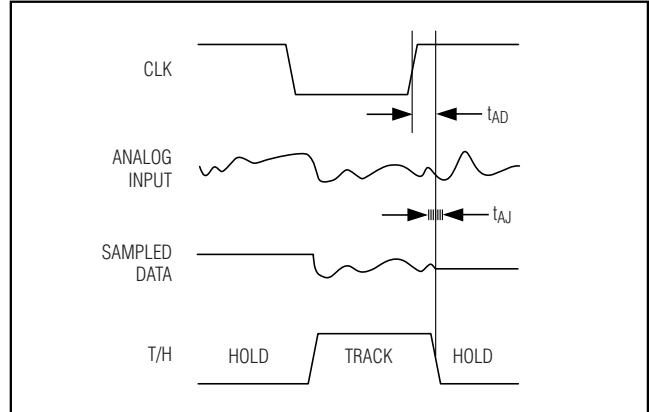

Figure 11. Aperture Jitter/Delay Specifications

Signal-to-Noise Plus Distortion (SINAD)

SINAD is computed by taking the ratio of the RMS signal to the RMS noise plus distortion. RMS noise plus distortion includes all spectral components to the Nyquist frequency, excluding the fundamental and the DC offset.

Effective Number of Bits (ENOB)

ENOB specifies the dynamic performance of an ADC at a specific input frequency and sampling rate. An ideal ADC's error consists of quantization noise only. ENOB for a full-scale sinusoidal input waveform is computed from:

$$\text{ENOB} = \left(\frac{\text{SINAD} - 1.76}{6.02} \right)$$

Total Harmonic Distortion (THD)

THD is the ratio of the RMS sum of the first six harmonics of the input signal to the fundamental itself. This is expressed as:

$$\text{THD} = 20 \times \log \left[\frac{\sqrt{V_2^2 + V_3^2 + V_4^2 + V_5^2 + V_6^2 + V_7^2}}{V_1} \right]$$

Quad, 12-Bit, 65Msps, 1.8V ADC with Serial LVDS Outputs

Spurious-Free Dynamic Range (SFDR)

SFDR is the ratio expressed in decibels of the RMS amplitude of the fundamental (maximum signal component) to the RMS value of the next-largest spurious component, excluding DC offset. SFDR is specified in decibels relative to the carrier (dBc).

Intermodulation Distortion (IMD)

IMD is the total power of the IM2 to IM5 intermodulation products to the Nyquist frequency relative to the total input power of the two input tones, f_1 and f_2 . The individual input tone levels are at -6.5dBFS. The intermodulation products are as follows:

- 2nd-order intermodulation products (IM2): $f_1 + f_2$, $f_2 - f_1$
- 3rd-order intermodulation products (IM3): $2 \times f_1 - f_2$, $2 \times f_2 - f_1$, $2 \times f_1 + f_2$, $2 \times f_2 + f_1$
- 4th-order intermodulation products (IM4): $3 \times f_1 - f_2$, $3 \times f_2 - f_1$, $3 \times f_1 + f_2$, $3 \times f_2 + f_1$
- 5th-order intermodulation products (IM5): $3 \times f_1 - 2 \times f_2$, $3 \times f_2 - 2 \times f_1$, $3 \times f_1 + 2 \times f_2$, $3 \times f_2 + 2 \times f_1$

Third-Order Intermodulation (IM3)

IM3 is the total power of the 3rd-order intermodulation product to the Nyquist frequency relative to the total input power of the two input tones f_1 and f_2 . The individual input tone levels are at -6.5dBFS. The 3rd-order intermodulation products are $2 \times f_1 - f_2$, $2 \times f_2 - f_1$, $2 \times f_1 + f_2$, $2 \times f_2 + f_1$.

Small-Signal Bandwidth

A small -20dBFS analog input signal is applied to an ADC so the signal's slew rate does not limit the ADC's performance. The input frequency is then swept up to the point where the amplitude of the digitized conversion result has decreased by -3dB.

Full-Power Bandwidth

A large -0.5dBFS analog input signal is applied to an ADC, and the input frequency is swept up to the point where the amplitude of the digitized conversion result has decreased by -3dB. This point is defined as full-power input bandwidth frequency.

Gain Matching

Gain matching is a figure of merit that indicates how well the gain of all four ADC channels is matched to each other. For the MAX1127, gain matching is measured by applying the same 30.3MHz, -0.5dBFS analog signal to all analog input channels. These analog inputs are sampled at 65MHz and the maximum deviation in amplitude is reported in dB as gain matching in the *Electrical Characteristics* table.

Phase Matching

Phase matching is a figure of merit that indicates how well the phase of all four ADC channels is matched to each other. For the MAX1127, phase matching is measured by applying the same 30.3MHz, -0.5dBFS analog signal to all analog input channels. These analog inputs are sampled at 65MHz and the maximum deviation in phase is reported in degrees as phase matching in the *Electrical Characteristics* table.

Quad, 12-Bit, 65MSPS, 1.8V ADC with Serial LVDS Outputs

Package Information

(The package drawing(s) in this data sheet may not reflect the most current specifications. For the latest package outline information, go to www.maxim-ic.com/packages.)

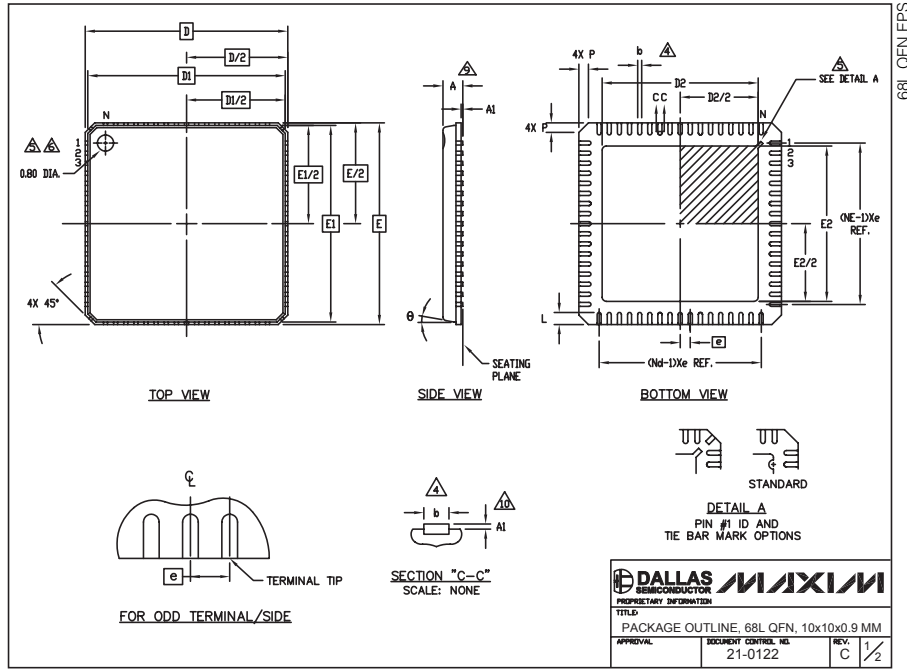

SYMBOL	COMMON DIMENSIONS			No. of
	MIN.	NOM.	MAX.	
A	-	0.90	1.00	
A1	0.00	0.01	0.05	11
b	0.18	0.23	0.30	4
D	10.00 BSC			
D1	9.75 BSC			
D2	0.50 BSC			
E	10.00 BSC			
E1	9.75 BSC			
L	0.50	0.60	0.65	
N	68			3
Nd	17			3
Ne	17			3
θ	0	12°		
P	0	0.42	0.60	

PKG CODE	D2			E2		
	MIN	NOM	MAX	MIN	NOM	MAX
G6800-2	7.55	7.70	7.85	7.55	7.70	7.85
G6800-4	5.65	5.80	5.95	5.65	5.80	5.95

Note: For the MAX1127 Exposed Pad Variation, the package code is G6800-4.

1. DIE THICKNESS ALLOWABLE IS .012 INCHES MAXIMUM.
 2. DIMENSIONING & TOLERANCES CONFORM TO ASME Y14.5M. - 1994.
 N IS THE NUMBER OF TERMINALS.
 Nd IS THE NUMBER OF TERMINALS IN X-DIRECTION &
 Ne IS THE NUMBER OF TERMINALS IN Y-DIRECTION.
 DIMENSION b APPLIES TO PLATED TERMINAL AND IS MEASURED BETWEEN 0.20 AND 0.25mm FROM TERMINAL TIP.
 THE PIN #1 IDENTIFIER MUST BE LOCATED ON THE TOP SURFACE OF THE PACKAGE BY USING INDENTATION MARK OR OTHER FEATURE OF PACKAGE BODY. DETAILS OF PIN #1 IDENTIFIER IS OPTIONAL, BUT MUST BE LOCATED WITHIN ZONE INDICATED.
 EXACT SHAPE AND SIZE OF THIS FEATURE IS OPTIONAL.
 ALL DIMENSIONS ARE IN MILLIMETERS.
 PACKAGE WARPAGE MAX 0.10mm.
 APPLIES TO EXPOSED SURFACE OF PADS AND TERMINALS.
 APPLIES ONLY TO TERMINALS.
 MEETS JEDEC MO-220.

DALLAS SEMICONDUCTOR **MAXIM**
PROPRIETARY INFORMATION
TITLE: PACKAGE OUTLINE, 68L QFN, 10x10x0.9 MM
APPROVAL: DOCUMENT CONTROL NO. 21-0122 REV. C 1/2

Maxim cannot assume responsibility for use of any circuitry other than circuitry entirely embodied in a Maxim product. No circuit patent licenses are implied. Maxim reserves the right to change the circuitry and specifications without notice at any time.