

ISL85403EVAL1Z Evaluation Board User Guide

Description

The ISL85403EVAL1Z board allows quick evaluation of the ISL85403 in the 2-stage boost-buck and the synchronous buck configurations. It is a cost effective solution for the low-power, wide input voltage range point-of-load application where both stepping up and stepping down voltage capabilities are required.

Specifications

The design specifications of the ISL85403EVAL1Z are shown in [Table 1](#).

TABLE 1. SPECIFICATIONS

PARAMETERS	VALUES
Input Voltage (V_{IN})	4V to 40V
Output Voltage (V_{OUT})	5.0V
Max. Output Current (IOUT_MAX)	2.5A
Switching Frequency	500kHz
Output Ripple	40mV

Key Features

- Flexible design
- V_{IN} range of 4V to 40V
- Convenient power connection

References

[ISL85403 Datasheet](#)

Ordering Information

PART NUMBER	DESCRIPTION
ISL85403EVAL1Z	ISL85403 Evaluation Board, 2-stage boost-buck configuration 5V output

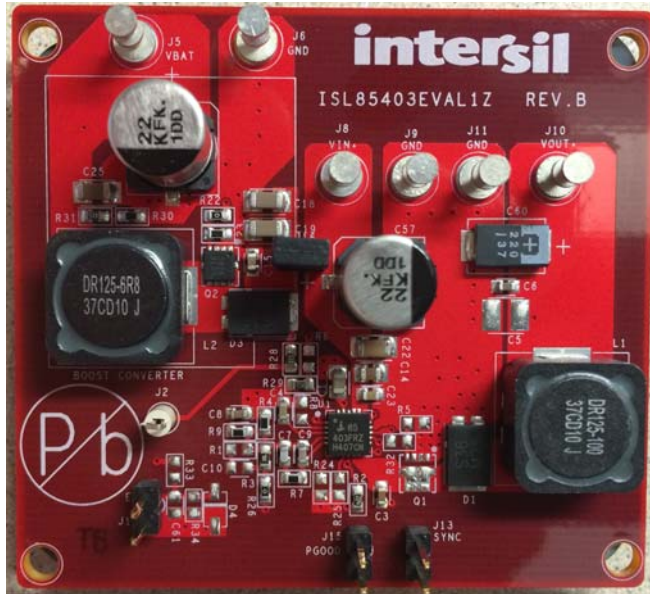

FIGURE 1. TOP VIEW



FIGURE 2. BOTTOM VIEW

Functional Description

The ISL85403 is a flexible switching regulator with an integrated 127mΩ high-side MOSFET. It can be used as a synchronous buck converter, a 2-stage boost-buck converter or a noninverting buck-boost converter.

The ISL85403EVAL1Z board demonstrates the operations of the ISL85403 in the 2-stage boost-buck configuration. It also allows the user to easily modify the board into synchronous buck configuration. The ISL85403EVAL1Z board is shown in [Figures 1](#) and [2](#).

The schematic is shown on [page 4](#), bill of materials on [page 5](#), and PCB layers for reference start on [page 9](#). [Figures 6](#) through [25](#) show performance data taken from the evaluation board.

Operating Range

For the 2-stage boost-buck configuration, the board input voltage range is 4V to 40V. The output voltage is set to 5V by default and can be changed by voltage feedback resistors R₃ and R₄, as shown in [Equation 1](#):

$$R_4 = R_3 \cdot \frac{V_{ref}}{V_{OUT} - V_{ref}} \quad (EQ. 1)$$

NOTE: In order to change to a higher output voltage, the output capacitors have to be changed for the higher voltage rating.

The board is set to a default frequency of 500kHz (FS pin/R₈ is open). The switching frequency can be programmed to other values by a resistor at R₈. Refer to the [ISL85403](#) datasheet for the resistor value and the switching frequency. The switching frequency can also be synchronized to external clock by connecting the external clock to the SYNC terminal (J13).

Quick Test Setup

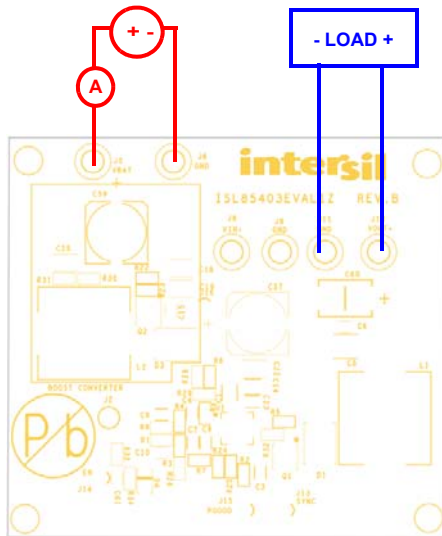

FIGURE 3. ISL85403EVAL1Z BOARD SETUP

1. Make sure that shunt is installed on J16.

2. Connect the power supply to the input terminals VBAT(J5) and GND (J6). Connect the load terminals to the output VOUT+ (J10) and GND (J11). Make sure the setup is correct prior to applying any power or load to the board.
3. Adjust the power supply to 4V to 40V and turn it on.
4. Verify the output voltage is 5V and use oscilloscope to monitor the phase node waveforms.

Board Modification for the Synchronous Buck Configuration

The following steps provide guidelines to modify the ISL85403EVAL1Z into the synchronous buck configuration.

1. Populate Q1 with the desired MOSFET.
 2. Remove the jumper on J16 to disconnect the boost power stage from the buck power stage
 3. Populate R₃₂ with 0Ω resistor and R₅ with 4.7kΩ resistor.
 4. Remove resistor R₂₂.
 5. Short EXT_BOOST pin to ground by removing R₃₁ and replacing R₃₀ with 0Ω resistor.
 6. If V_{CC} switch-over feature is needed, remove the resistors R₂₈ and R₂₉ and populate R₆ with 0Ω resistor.
 7. Removing the diode D1 is optional. Generally the SS3P6 will help reducing losses associated with the MOSFET's body diode, yielding better efficiency.
1. Connect the power supply to the input terminals VIN+ (J8) and GND (J9). Connect the load terminals to the output VOUT+ (J10) and GND (J11). Make sure the setup is correct prior to applying any power or load to the board.
 2. Adjust the power supply to 8V to 40V and turn it on.

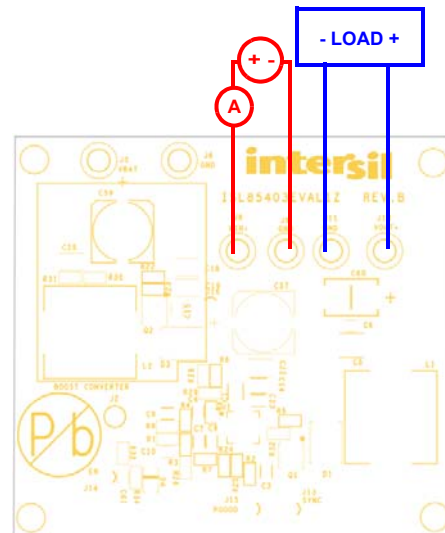

FIGURE 4. ISL85403EVAL1Z IN THE SYNCHRONOUS BUCK CONFIGURATION BOARD SET UP

PCB Layout Guidelines

1. Place the coupling ceramic capacitors as closely as possible to the IC VIN pin and cathode of the power diode (D1). Keep this loop (coupling ceramic capacitor, IC VIN pin and diode) as small as possible to minimize the voltage spikes induced by the trace parasitic inductance. A bulk capacitor, C59 (as shown in the [“ISL85403EVAL1Z Circuit Schematic” on page 4](#)), is included to support long wire connections from power supplies to the evaluation board.
2. Keep the phase node copper area small but large enough to handle the load current.
3. Place the output ceramic and aluminum capacitors close to the power stage components as well.
4. Place vias (at least 9) in the bottom pad of the IC. The bottom pad should be placed in ground copper plane with an area as large as possible in multiple layers to effectively reduce the thermal impedance.
5. Place the 4.7 μ F ceramic decoupling capacitor C1 (as shown in the [“ISL85403EVAL1Z Circuit Schematic” on page 4](#)) as close as possible to the IC's VCC pin. Put multiple vias close to the ground pad of this capacitor.
6. Keep the bootstrap capacitor close to the IC.
7. Place the output voltage sense trace close to the place that is to be strictly regulated.
8. Place all the peripheral control components close to the IC.

ISL85403EVAL1Z Circuit Schematic

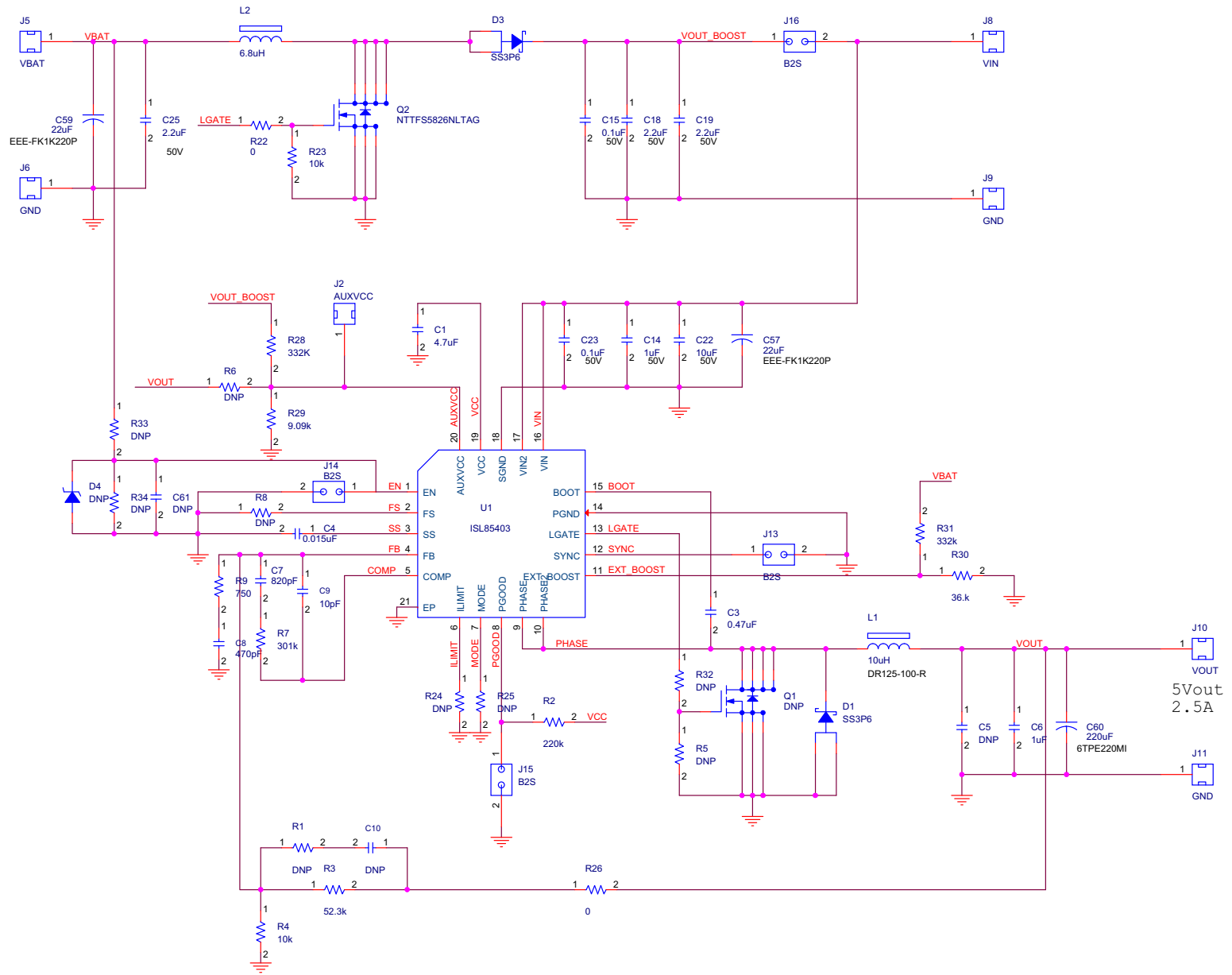

FIGURE 5. ISL85403EVAL1Z SCHEMATIC

User Guide 024

Bill of Materials

REF DES	PART NUMBER	QTY	DESCRIPTION	MANUFACTURER
C6	C1608X7R1C105K	1	CAP, SMD, 0603, 1.0µF, 16V, 10%, X7R, ROHS	TDK
C57, 59	EEE-FK1K220P	2	CAP, SMD, 8X10.2, 22µF, 80V, 20%, ALUM.ELEC., ROHS	PANASONIC
C9	VARIOUS	1	CAP, SMD, 0603, 10pF, 50V, 5%, COG, ROHS	VARIOUS
C15, C23	VARIOUS	1	CAP, SMD, 0603, 0.1µF, 50V, 10%, X7R, ROHS	VARIOUS
C4	VARIOUS	1	CAP, SMD, 0603, 0.015µF, 50V, 10%, X7R, ROHS	VARIOUS
C8	VARIOUS	1	CAP, SMD, 0603, 470pF, 50V, 5%, NPO, ROHS	VARIOUS
C3	C1608X7R1H474K	1	CAP, SMD, 0603, 0.47µF, 50V, 10%, X7R, ROHS	TDK
C7	VARIOUS	1	CAP, SMD, 0603, 820pF, 50V, 5%, COG, ROHS	VARIOUS
C14	VARIOUS	1	CAP, SMD, 0805, 1.0µF, 50V, 10%, X7R, ROHS	VARIOUS
C1	0805ZD475KAT2A	1	CAP, SMD, 0805, 4.7µF, 10V, 10%, X5R, ROHS	AVX
C22	VARIOUS	1	CAP, SMD, 1206, 10µF, 50V, 10%, X5R, ROHS	VARIOUS
C18, C19, C25	GRM31CR71H225KA88L	3	CAP, SMD, 1206, 2.2µF, 50V, 10%, X7R, ROHS	MURATA
C60	6TPE220MI	1	CAP-POSCAP, SMD, 7.3x4.3x1.8, 220µF, 6.3V, 20%, 18mΩ, ROHS	SANYO
L1	DR125-100-R	1	COIL-PWR INDUCTOR, SMD, 12.5mm, 10µH, 20%, 5.35A, ROHS	COILTRONICS
L2	DR125-6R8-R	1	COIL-PWR INDUCTOR, SMD, 12.5mm, 6.8µH, 20%, 6.64A, ROHS	COILTRONICS
D1, D3	SS6P3LHM3/86A	2	DIODE-SCHOTTKY RECTIFIER, SMD, SMPC, 60V, 3A, ROHS	VISHAY
U1	ISL85403IRZ	1	IC-SWITCHING REGULATOR, 20P, QFN, 4X4, ROHS	INTERSIL
Q2	BSZ100N06LS3G	1	TRANSIST-MOS, N-CHANNEL, 8P, PG-TSDSON-8, 60V, 20A, ROHS	INFINEON
R2	VARIOUS	1	RES, SMD, 0603, 220k, 1/10W, 1%, TF, ROHS	VARIOUS
R3	VARIOUS	1	RES, SMD, 0603, 52.3k, 1/10W, 1%, TF, ROHS	VARIOUS
R4, R23	VARIOUS	2	RES, SMD, 0603, 10k, 1/10W, 1%, TF, ROHS	VARIOUS
R7	VARIOUS	1	RES, SMD, 0603, 301k, 1/10W, 1%, TF, ROHS	VARIOUS
R9	VARIOUS	1	RES, SMD, 0603, 750Ω, 1/10W, 1%, TF, ROHS	VARIOUS
R22, R26	VARIOUS	2	RES, SMD, 0603, 0Ω, 1/10W, TF, ROHS	VARIOUS
R28, R31	VARIOUS	2	RES, SMD, 0603, 332k, 1/10W, 1%, TF, ROHS	VARIOUS
R29	VARIOUS	1	RES, SMD, 0603, 9.09k, 1/10W, 1%, TF, ROHS	VARIOUS
R30	VARIOUS	1	RES, SMD, 0603, 36k, 1/10W, 1%, TF, ROHS	VARIOUS
R1, R5, R6, R8, R24, R25, R32, R33, R34, C5, C10, C61, D4, Q1	N/A	0	Do not populate	N/A

Typical Performance Curves

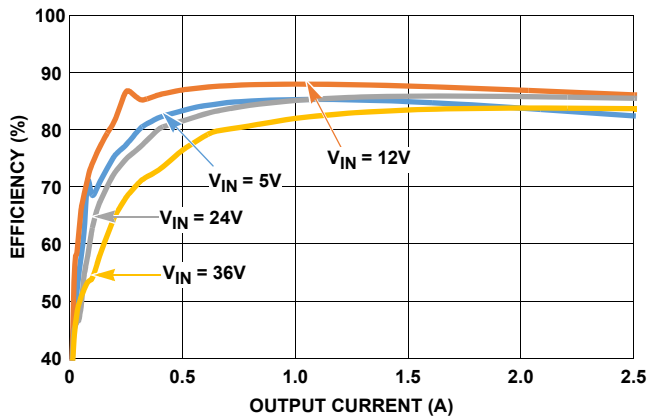

FIGURE 6. EFFICIENCY vs LOAD

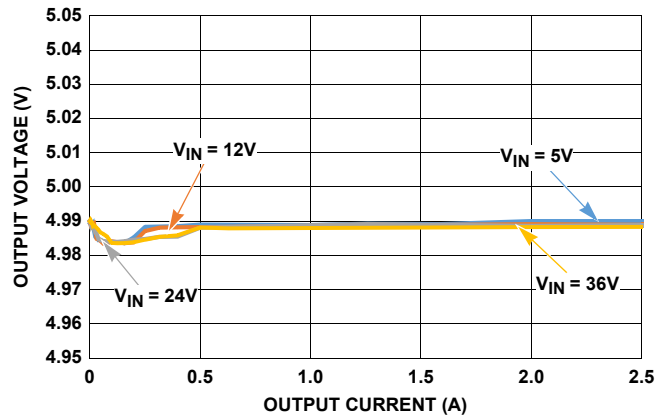

FIGURE 7. LOAD REGULATION

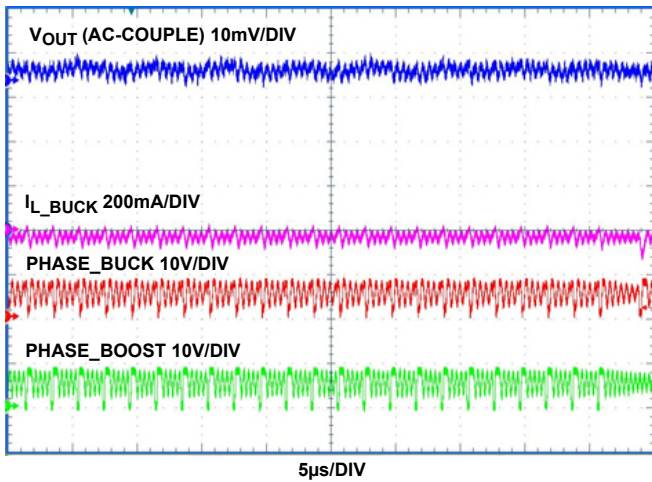

FIGURE 8. OUTPUT RIPPLE AT 0A LOAD ($V_{IN} = 5V$)

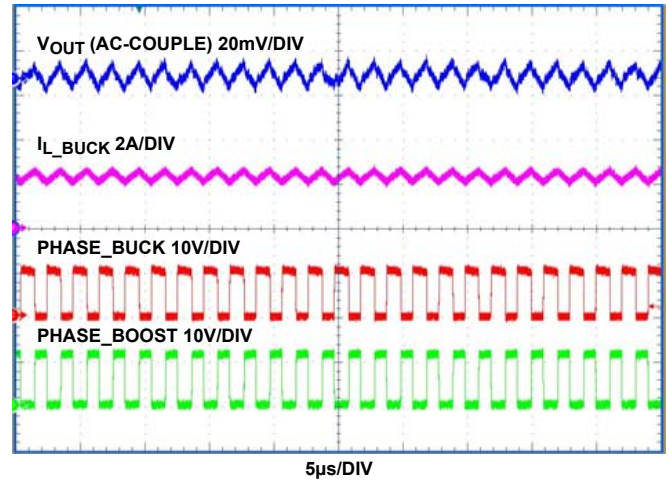

FIGURE 9. OUTPUT RIPPLE AT 2.5A LOAD ($V_{IN} = 5V$)

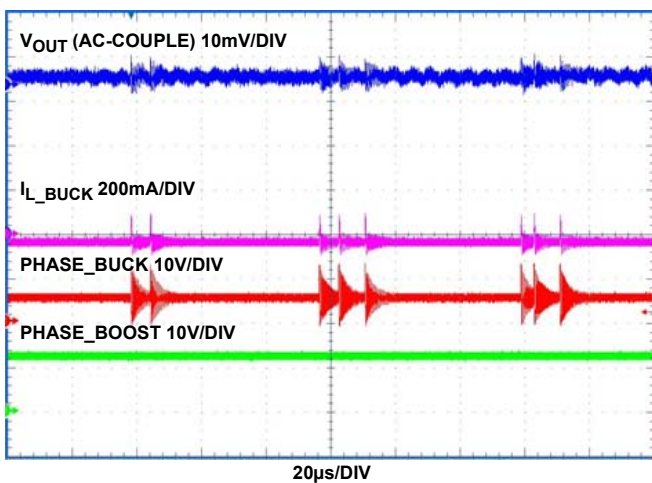

FIGURE 10. OUTPUT RIPPLE AT 0A LOAD ($V_{IN} = 12V$)

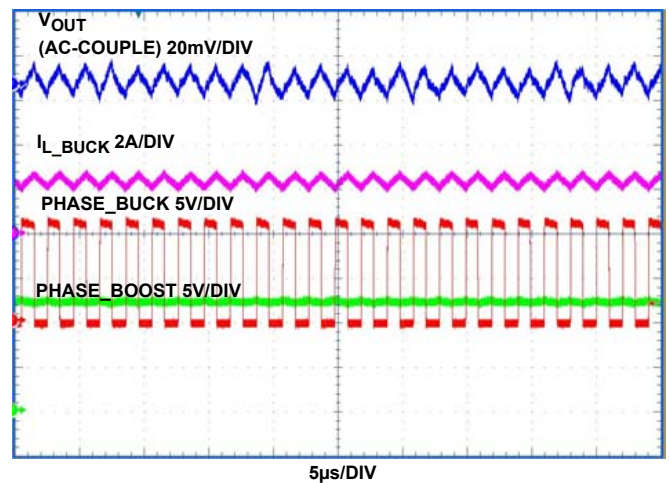

FIGURE 11. OUTPUT RIPPLE AT 2.5A LOAD ($V_{IN} = 12V$)

Typical Performance Curves (Continued)

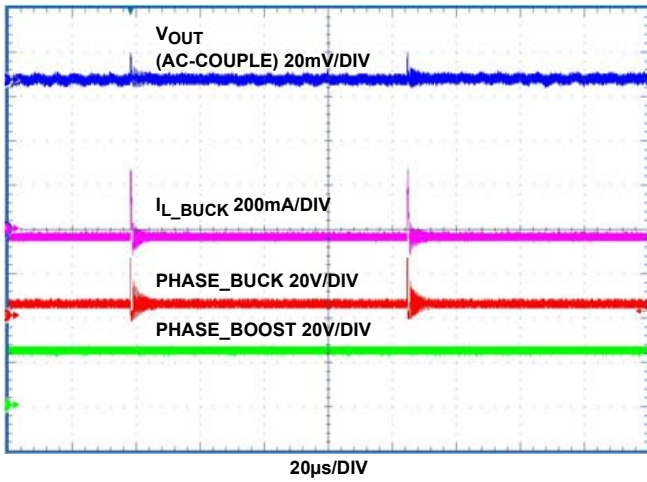

FIGURE 12. OUTPUT RIPPLE AT 0A LOAD ($V_{IN} = 24V$)

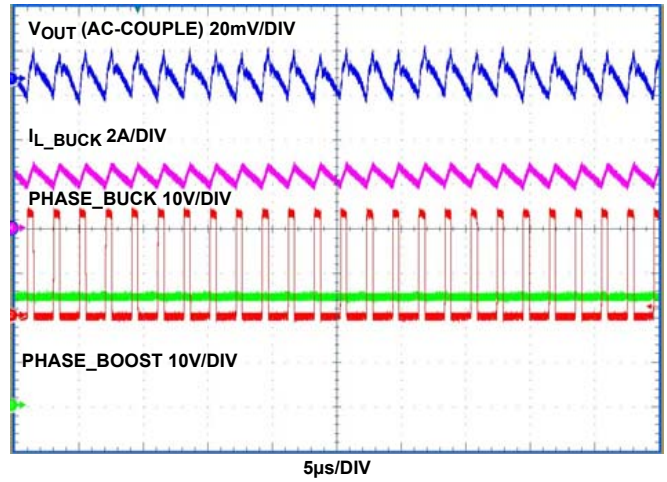

FIGURE 13. OUTPUT RIPPLE AT 2.5A LOAD ($V_{IN} = 24V$)

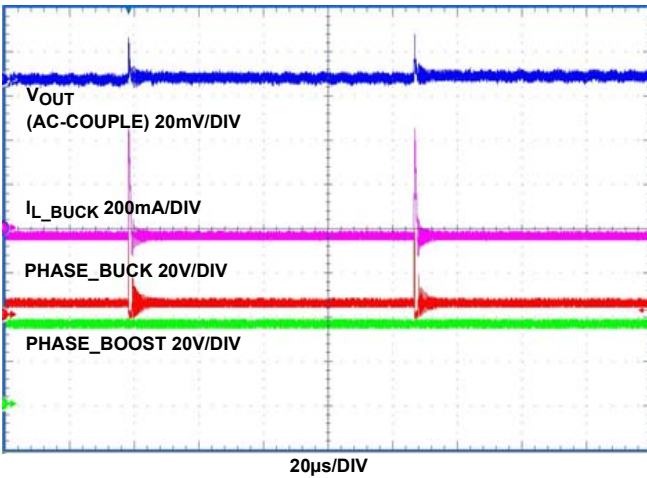

FIGURE 14. OUTPUT RIPPLE AT 0A LOAD ($V_{IN} = 36V$)

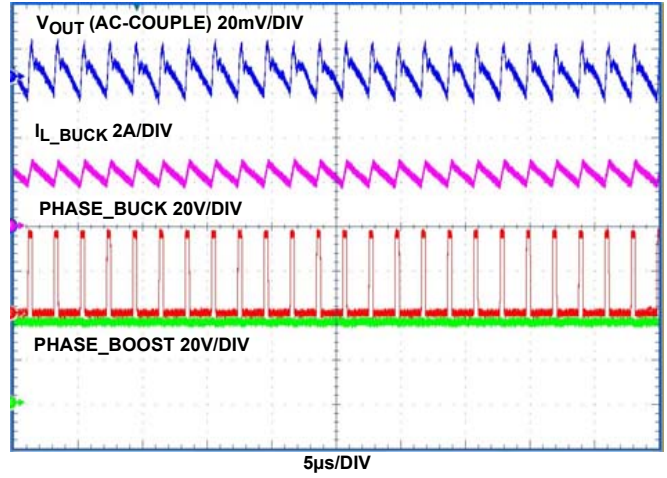

FIGURE 15. OUTPUT RIPPLE AT 2.5A LOAD ($V_{IN} = 36V$)

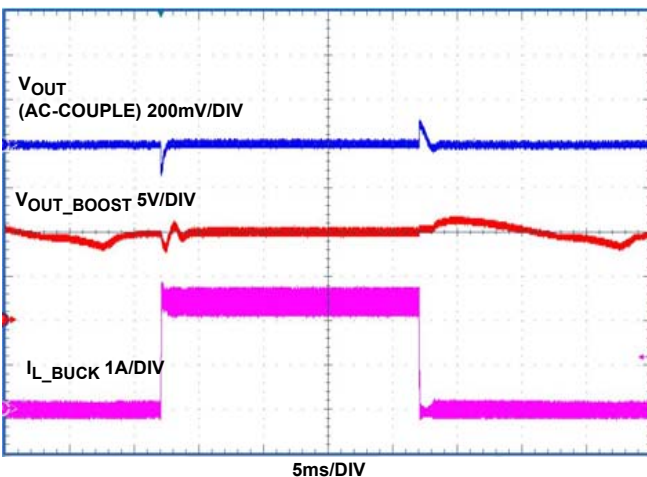

FIGURE 16. LOAD TRANSIENT RESPONSE 0A->2.5A, $V_{IN} = 5V$

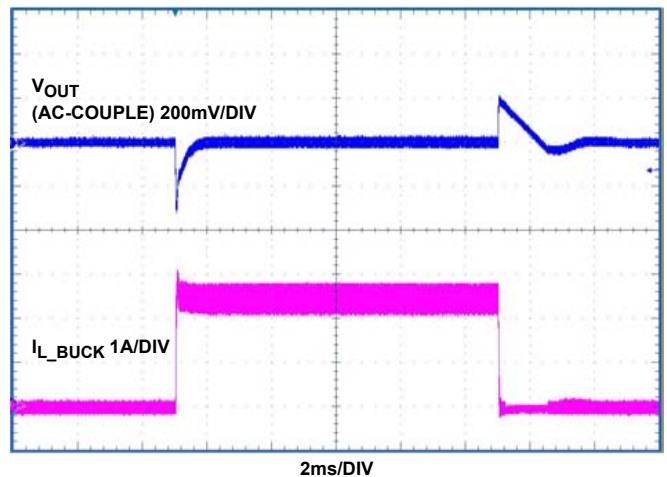

FIGURE 17. LOAD TRANSIENT RESPONSE 0A->2.5A, $V_{IN} = 12V$

Typical Performance Curves (Continued)

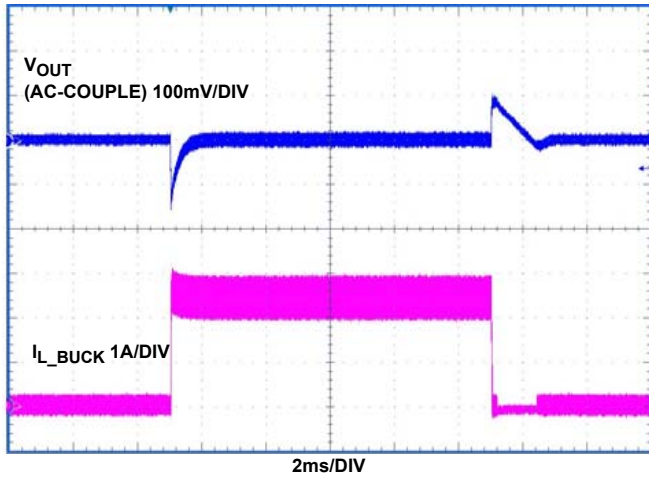

FIGURE 18. LOAD TRANSIENT RESPONSE 0A->2.5A, $V_{IN} = 24V$

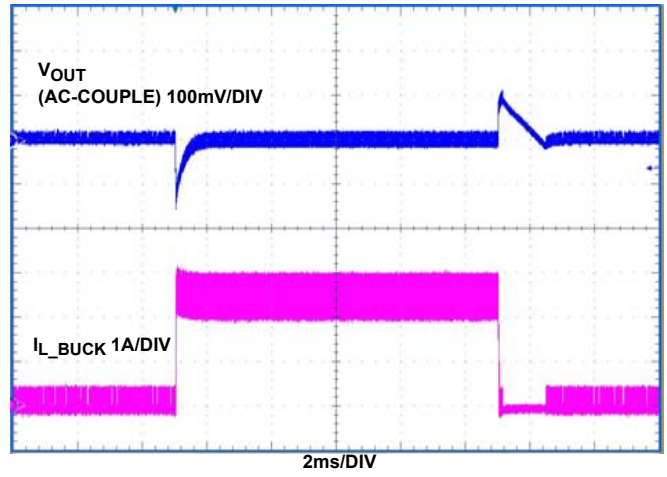

FIGURE 19. LOAD TRANSIENT RESPONSE 0A->2.5A, $V_{IN} = 36V$

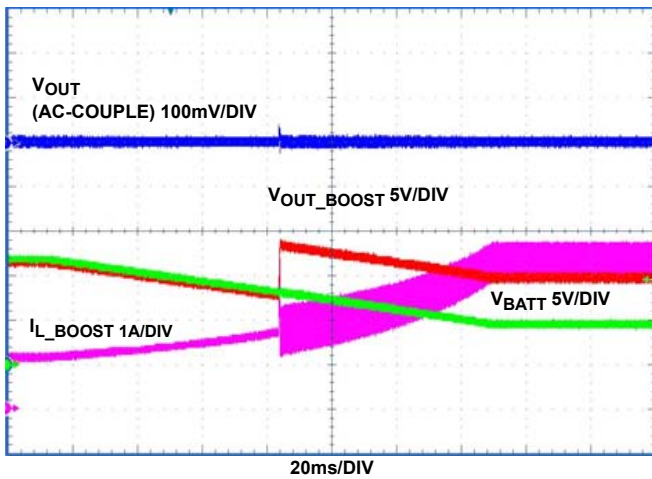

FIGURE 20. BOOST-BUCK MODE, INPUT TRANSITION FROM 12V TO 5V, 2.5A LOAD

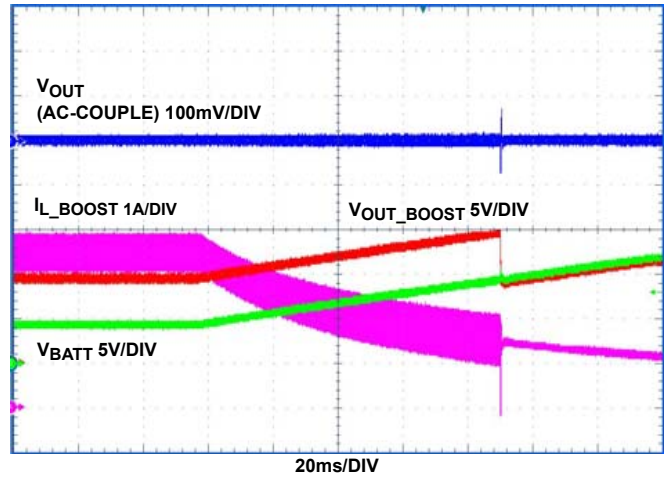

FIGURE 21. BOOST-BUCK MODE, INPUT TRANSITION FROM 5V TO 12V, 2.5A LOAD

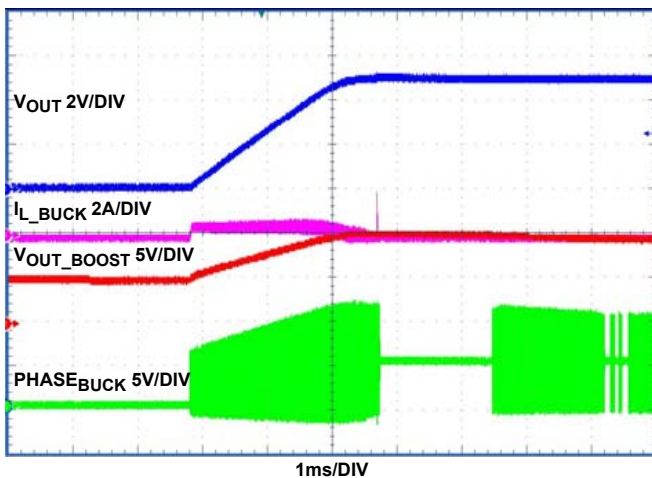

FIGURE 22. SOFT-START AT 0A LOAD ($V_{IN} = 5V$)

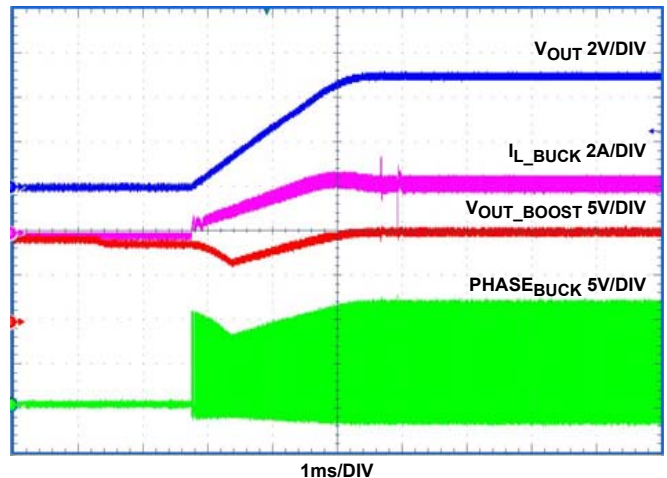

FIGURE 23. SOFT-START WITH 2Ω LOAD ($V_{IN} = 5V$)

Typical Performance Curves (Continued)

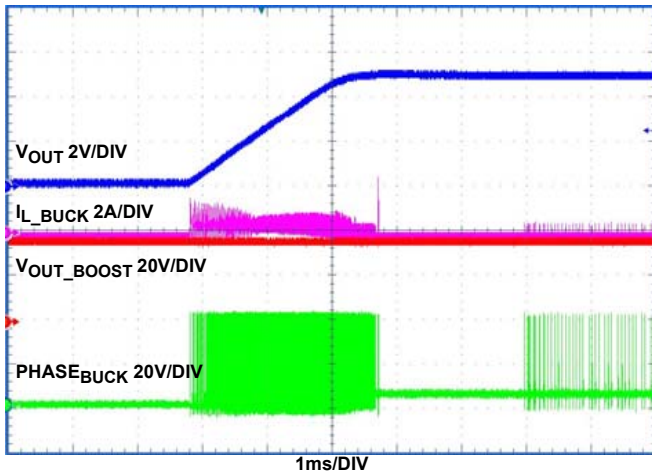

FIGURE 24. SOFT-START AT 0A LOAD ($V_{IN} = 36V$)

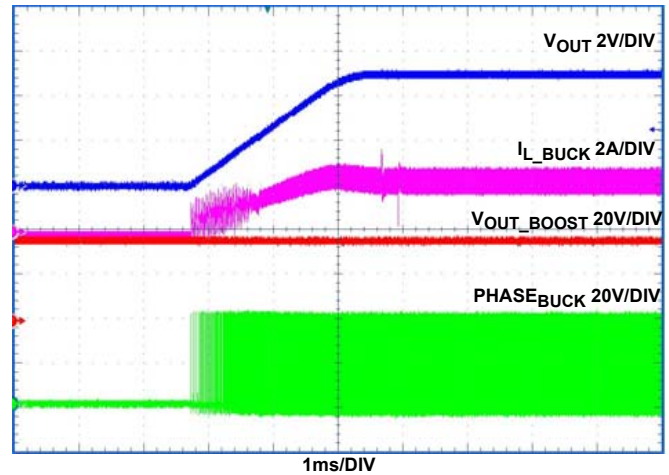

FIGURE 25. SOFT-START WITH 2Ω LOAD ($V_{IN} = 36V$)

Board Layout

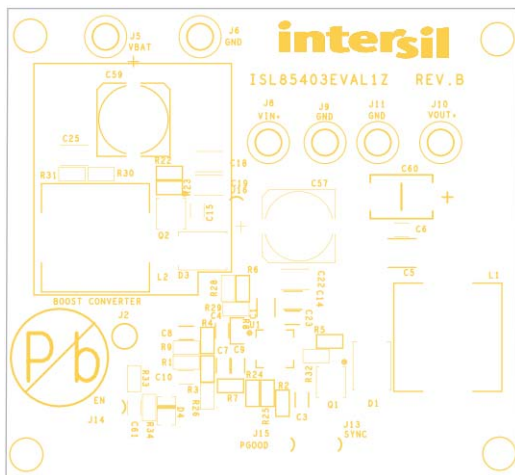

FIGURE 26. SILKSCREEN TOP

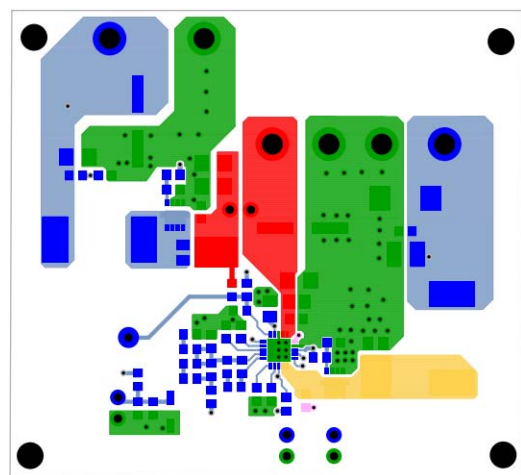

FIGURE 27. TOP LAYER

Board Layout (Continued)

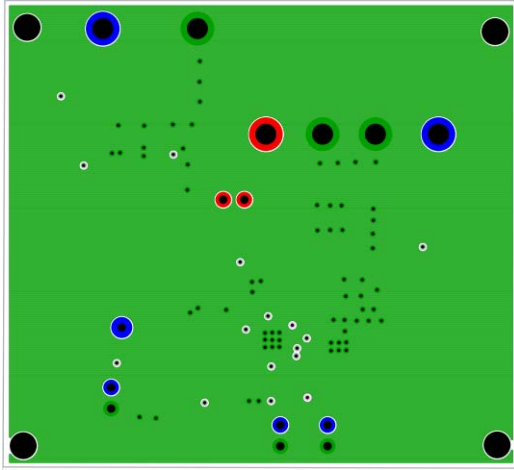

FIGURE 28. 2nd LAYER

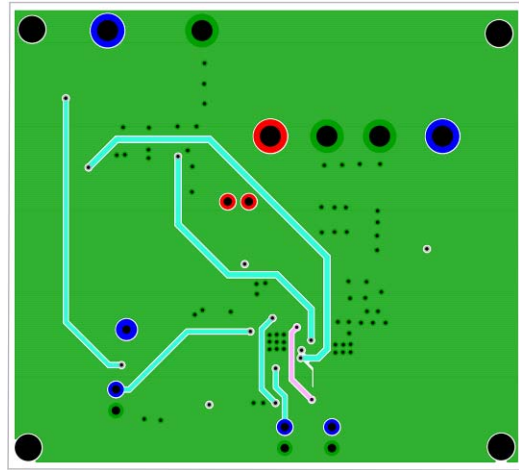

FIGURE 29. 3rd LAYER

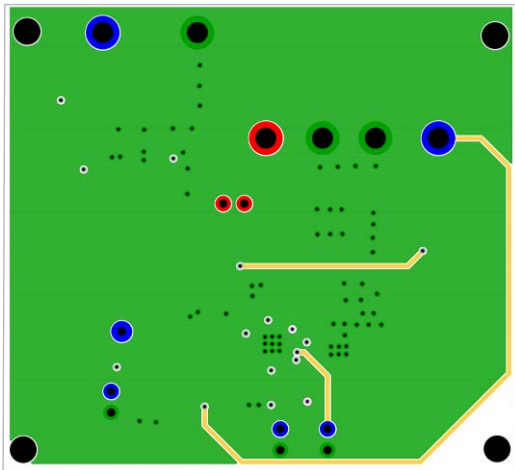

FIGURE 30. BOTTOM LAYER



FIGURE 31. SILKSCREEN BOTTOM

Intersil Corporation reserves the right to make changes in circuit design, software and/or specifications at any time without notice. Accordingly, the reader is cautioned to verify that the document is current before proceeding.

For information regarding Intersil Corporation and its products, see www.intersil.com