

Buck chopper MOSFET Power Module

$V_{DSS} = 200V$
 $R_{DSon} = 8m\Omega$ typ @ $T_j = 25^\circ C$
 $I_D = 208A$ @ $T_c = 25^\circ C$

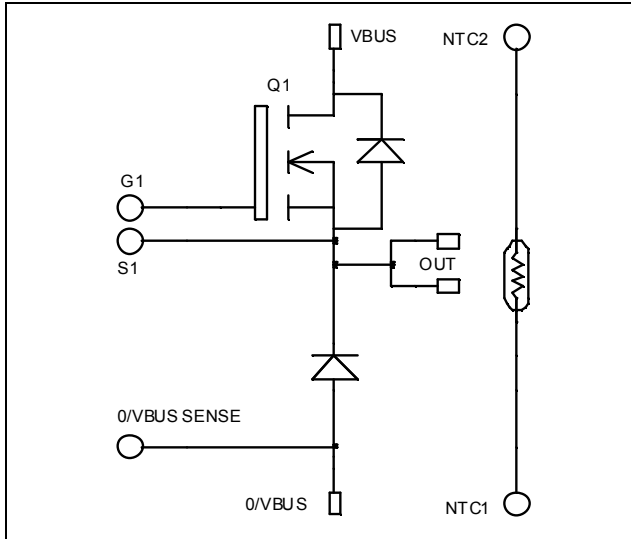

Application

- AC and DC motor control
- Switched Mode Power Supplies

Features

- Power MOS 7[®] MOSFETs
 - Low R_{DSon}
 - Low input and Miller capacitance
 - Low gate charge
 - Avalanche energy rated
 - Very rugged
- Kelvin source for easy drive
- Very low stray inductance
 - Symmetrical design
 - Lead frames for power connections
- Internal thermistor for temperature monitoring
- High level of integration

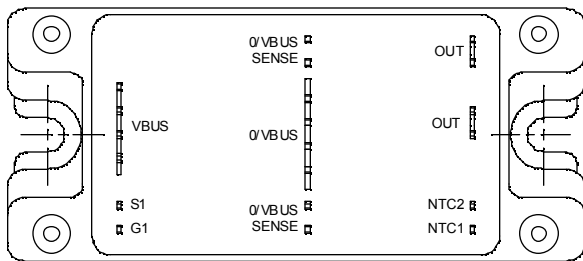

Benefits

- Outstanding performance at high frequency operation
- Direct mounting to heatsink (isolated package)
- Low junction to case thermal resistance
- Solderable terminals both for power and signal for easy PCB mounting
- Low profile
- RoHS Compliant

Absolute maximum ratings

Symbol	Parameter	Max ratings	Unit	
V_{DSS}	Drain - Source Breakdown Voltage	200	V	
I_D	Continuous Drain Current	$T_c = 25^\circ C$	A	
		$T_c = 80^\circ C$		155
I_{DM}	Pulsed Drain current	832		
V_{GS}	Gate - Source Voltage	± 30	V	
R_{DSon}	Drain - Source ON Resistance	10	$m\Omega$	
P_D	Maximum Power Dissipation	$T_c = 25^\circ C$	781	W
I_{AR}	Avalanche current (repetitive and non repetitive)	100	A	
E_{AR}	Repetitive Avalanche Energy	50	mJ	
E_{AS}	Single Pulse Avalanche Energy	3000		

CAUTION: These Devices are sensitive to Electrostatic Discharge. Proper Handling Procedures Should Be Followed. See application note APT0502 on www.microsemi.com

All ratings @ $T_j = 25^\circ\text{C}$ unless otherwise specified

Electrical Characteristics

Symbol	Characteristic	Test Conditions	Min	Typ	Max	Unit
I_{DSS}	Zero Gate Voltage Drain Current	$V_{GS} = 0\text{V}, V_{DS} = 200\text{V}$			375	μA
		$V_{GS} = 0\text{V}, V_{DS} = 160\text{V}$	$T_j = 125^\circ\text{C}$		1500	
$R_{DS(on)}$	Drain – Source on Resistance	$V_{GS} = 10\text{V}, I_D = 104\text{A}$		8	10	$\text{m}\Omega$
$V_{GS(th)}$	Gate Threshold Voltage	$V_{GS} = V_{DS}, I_D = 5\text{mA}$	3		5	V
I_{GSS}	Gate – Source Leakage Current	$V_{GS} = \pm 30\text{V}, V_{DS} = 0\text{V}$			± 150	nA

Dynamic Characteristics

Symbol	Characteristic	Test Conditions	Min	Typ	Max	Unit
C_{iss}	Input Capacitance	$V_{GS} = 0\text{V}$		14.4		nF
C_{oss}	Output Capacitance	$V_{DS} = 25\text{V}$		4.66		
C_{rss}	Reverse Transfer Capacitance	$f = 1\text{MHz}$		0.29		
Q_g	Total gate Charge	$V_{GS} = 10\text{V}$		280		nC
Q_{gs}	Gate – Source Charge	$V_{Bus} = 100\text{V}$		106		
Q_{gd}	Gate – Drain Charge	$I_D = 208\text{A}$		134		
$T_{d(on)}$	Turn-on Delay Time	Inductive switching @ 125°C		32		ns
T_r	Rise Time	$V_{GS} = 15\text{V}$		64		
$T_{d(off)}$	Turn-off Delay Time	$V_{Bus} = 133\text{V}$		88		
T_f	Fall Time	$I_D = 208\text{A}$ $R_G = 2.5\Omega$		116		
E_{on}	Turn-on Switching Energy	Inductive switching @ 25°C		1698		μJ
E_{off}	Turn-off Switching Energy	$V_{GS} = 15\text{V}, V_{Bus} = 133\text{V}$ $I_D = 208\text{A}, R_G = 2.5\Omega$		1858		
E_{on}	Turn-on Switching Energy	Inductive switching @ 125°C		1872		μJ
E_{off}	Turn-off Switching Energy	$V_{GS} = 15\text{V}, V_{Bus} = 133\text{V}$ $I_D = 208\text{A}, R_G = 2.5\Omega$		1972		

Chopper diode ratings and characteristics

Symbol	Characteristic	Test Conditions	Min	Typ	Max	Unit
V_{RRM}	Maximum Peak Repetitive Reverse Voltage		200			V
I_{RM}	Maximum Reverse Leakage Current	$V_R = 200\text{V}$	$T_j = 25^\circ\text{C}$		500	μA
			$T_j = 125^\circ\text{C}$		750	
I_F	DC Forward Current			180		A
V_F	Diode Forward Voltage	$I_F = 180\text{A}$		1.1	1.15	V
		$I_F = 360\text{A}$		1.4		
		$I_F = 180\text{A}$	$T_j = 125^\circ\text{C}$	0.9		
t_{rr}	Reverse Recovery Time	$I_F = 180\text{A}$ $V_R = 133\text{V}$	$T_j = 25^\circ\text{C}$	31		ns
			$T_j = 125^\circ\text{C}$	60		
Q_{rr}	Reverse Recovery Charge	$di/dt = 600\text{A}/\mu\text{s}$	$T_j = 25^\circ\text{C}$	180		nC
			$T_j = 125^\circ\text{C}$	750		

Thermal and package characteristics

Symbol	Characteristic	Min	Typ	Max	Unit	
R _{thJC}	Junction to Case Thermal Resistance	Transistor		0.16	°C/W	
		Diode		0.32		
V _{ISOL}	RMS Isolation Voltage, any terminal to case t=1 min, I _{isol} <1mA, 50/60Hz	2500			V	
T _J	Operating junction temperature range	-40		150	°C	
T _{STG}	Storage Temperature Range	-40		125		
T _C	Operating Case Temperature	-40		100		
Torque	Mounting torque	To Heatsink	M5	2.5	4.7	N.m
Wt	Package Weight				160	g

Temperature sensor NTC (see application note APT0406 on www.microsemi.com for more information).

Symbol	Characteristic	Min	Typ	Max	Unit
R ₂₅	Resistance @ 25°C		50		kΩ
B _{25/85}	T ₂₅ = 298.15 K		3952		K

$$R_T = \frac{R_{25}}{\exp\left[B_{25/85}\left(\frac{1}{T_{25}} - \frac{1}{T}\right)\right]}$$

T: Thermistor temperature
 R_T: Thermistor value at T

SP4 Package outline (dimensions in mm)

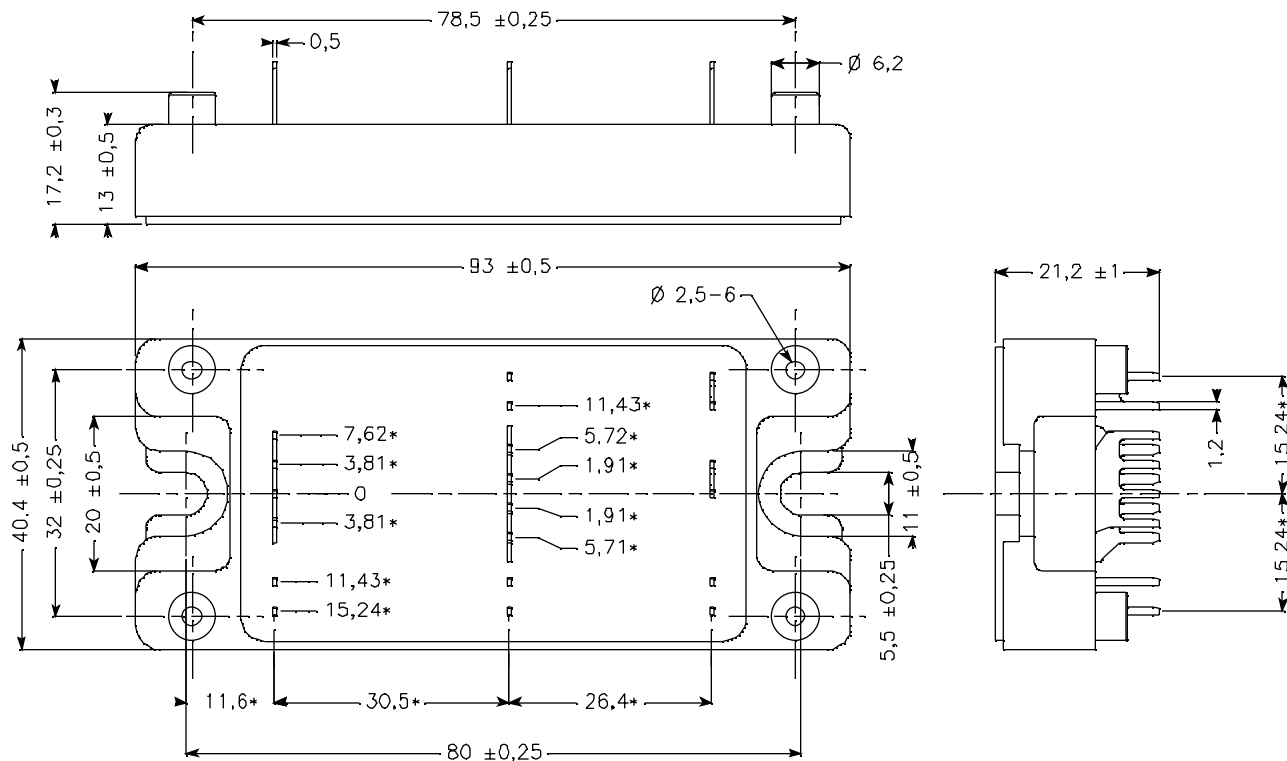

ALL DIMENSIONS MARKED "*" ARE TOLERANCED AS: $\boxed{\oplus \ominus 0.1}$

See application note APT0501 - Mounting Instructions for SP4 Power Modules on www.microsemi.com

Typical Performance Curve

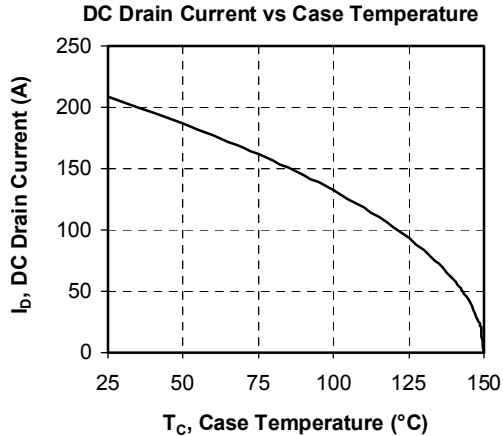
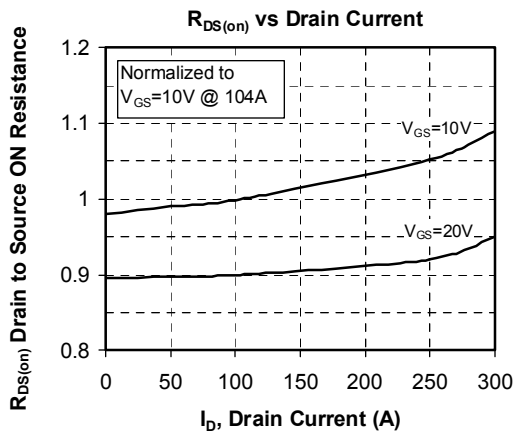
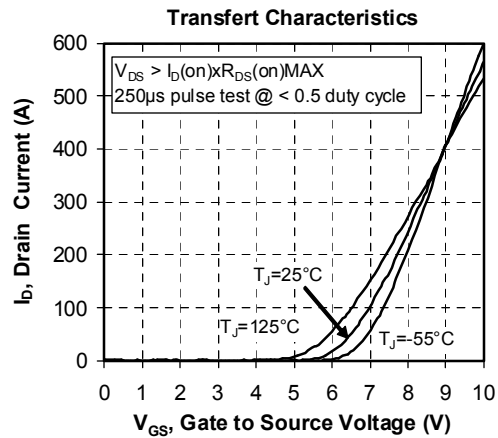
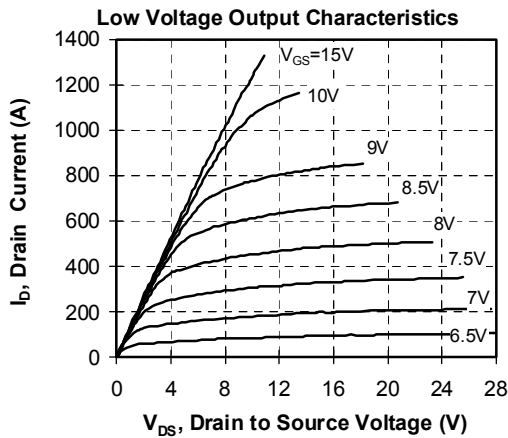
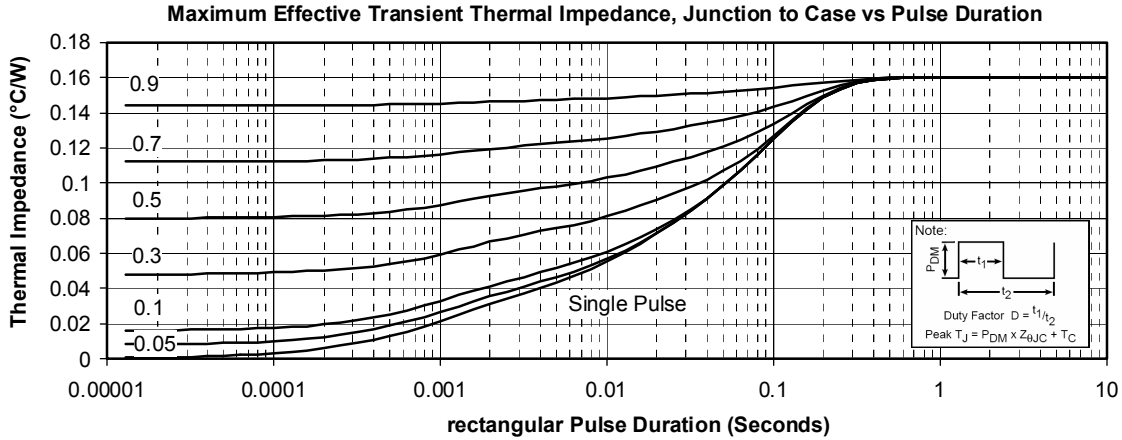

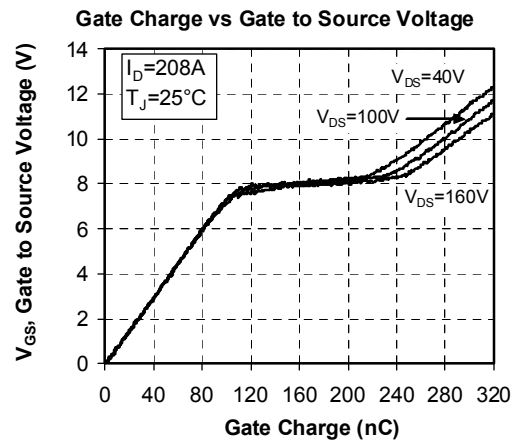
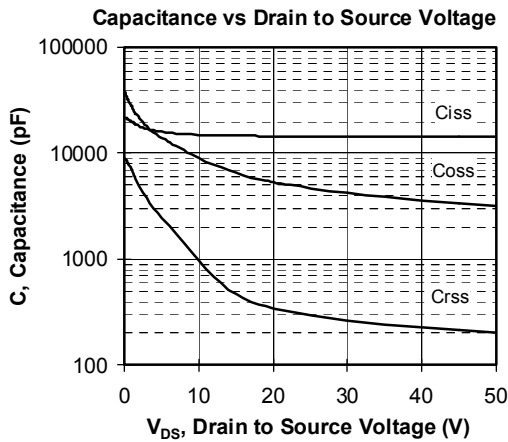
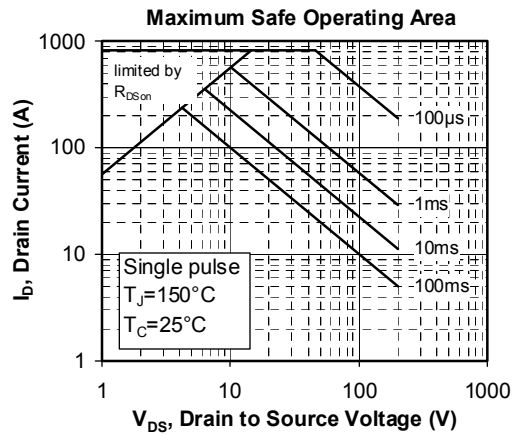
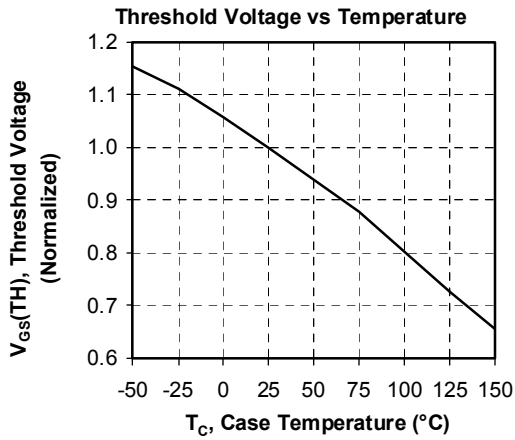
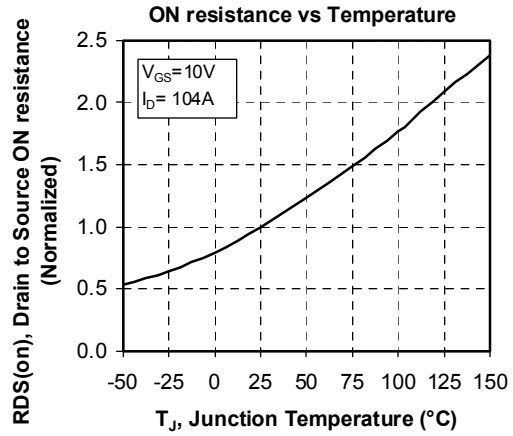

Delay Times vs Current

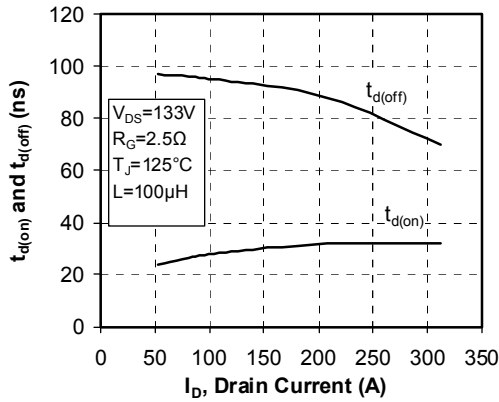

Rise and Fall times vs Current

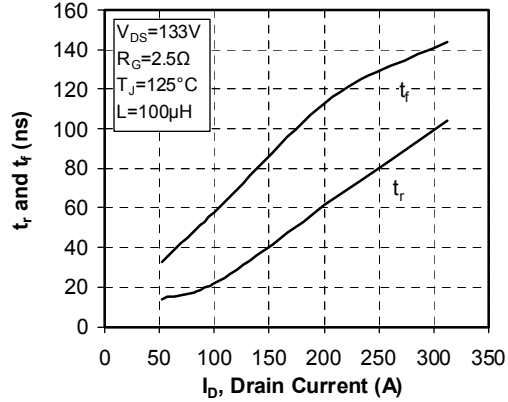

Switching Energy vs Current

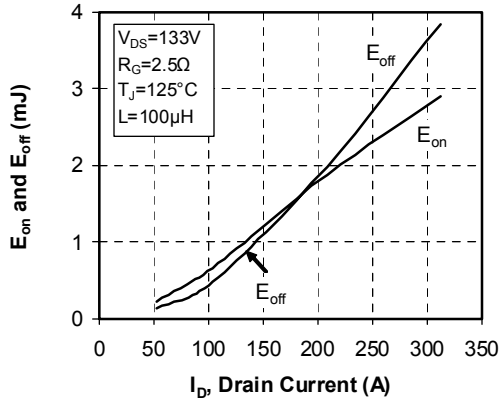

Switching Energy vs Gate Resistance

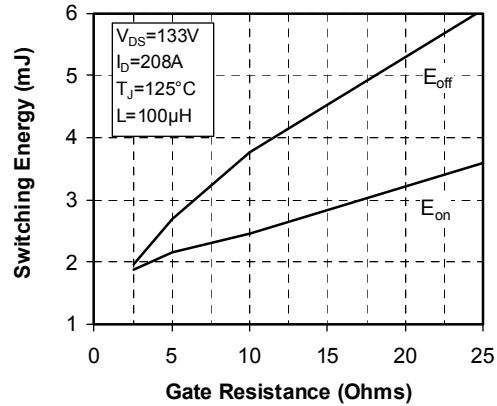

Operating Frequency vs Drain Current

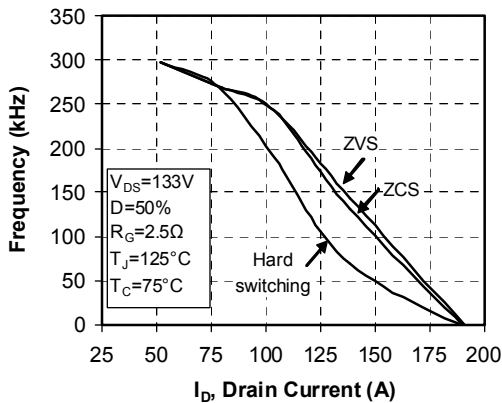

Source to Drain Diode Forward Voltage

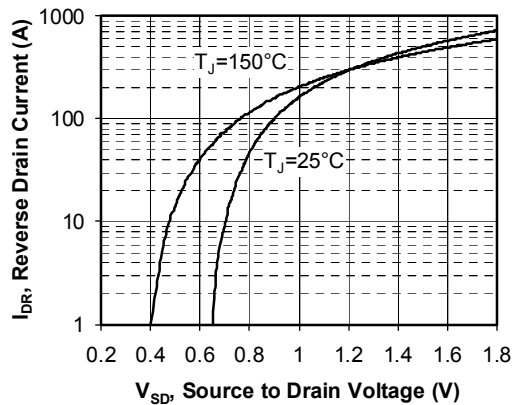

Microsemi reserves the right to change, without notice, the specifications and information contained herein

Microsemi's products are covered by one or more of U.S. patents 4,895,810 5,045,903 5,089,434 5,182,234 5,019,522 5,262,336 6,503,786 5,256,583 4,748,103 5,283,202 5,231,474 5,434,095 5,528,058 and foreign patents. U.S. and Foreign patents pending. All Rights Reserved.