

Introduction

The ISL8107 is a single-phase PWM controller that operates from 9V to 75V bias supply voltage. The PWM controller drives an external high-side N-Channel MOSFET in a non-synchronous buck converter topology. The ISL8107 features input voltage feed-forward compensation and overcurrent protection, etc. For a more detailed description of the ISL8107 functionality, refer to the ISL8107 Data Sheet <http://www.intersil.com/data/fn/fn6605.pdf>.

The ISL8107EVAL2Z Reference Design

The ISL8107EVAL2Z evaluation board is designed to meet the output voltage and current specifications shown in Table 1. Schematic, bill of materials, and layout plots are included.

TABLE 1. ISL8107EVAL2Z DESIGN PARAMETERS

PARAMETER	MIN	TYP	MAX
Input Voltage (V _{IN})	18V	48V	75V
Output Voltage (V _{OUT})		12V	
Output Voltage Ripple		30mV	
Continuous Load Current			5A
Switching Frequency		200kHz	

Quick Start Evaluation

Figure 1 shows a photograph of the ISL8107EVAL2Z board.

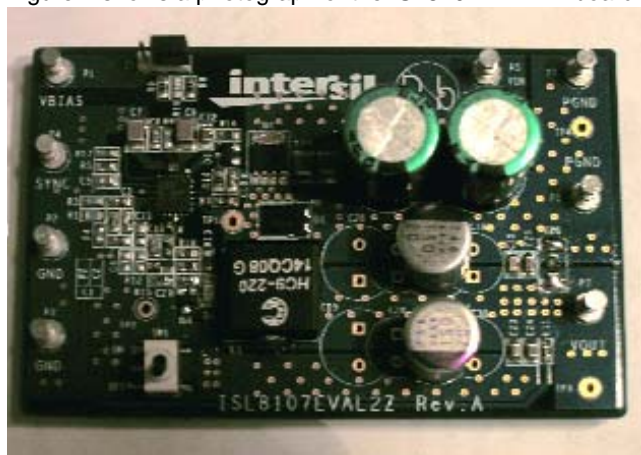

FIGURE 1. ISL8107EVAL2Z

Circuit Setup

The input supply of the power stage can be connected to the terminals P5 (V_{IN}) and P6 (PGND). For single supply application, the ISL8107's bias supply can be tied to V_{IN} through J1 with shunt between pins 2 and 3. When using separate supplies, provide the ISL8107 bias voltage through P1 (VBIAS) with J1's shunt between pins 1 and 2. The load can be connected to terminal P7 (V_{OUT}) and P8 (PGND). TP3 and TP4 can be used for DMM to measure the output voltage. Enabling and disabling the controller can be done through the toggle switch, SW1.

ISL8107EVAL2Z Performance

Start-Up

Figure 2 shows the start-up waveforms of the ISL8107EVAL2Z. Upon the VCC and VFF exceeding their rising POR thresholds, the ISL8107 provides initially 2μA to charge the soft-start capacitor, C_{SS}, connected to the ENSS pin. If the voltage at this pin is allowed to rise (the toggle switch, SW1, at ON position), the voltage on ENSS pin will ramp-up with at a slope determined by the 2μA current and the value of the soft-start capacitor. When the voltage at ENSS reaches 0.77V, the oscillator circuit is active, and generates sawtooth waveform. At the same time, the soft-start current is increased to 33μA; the ENSS voltage then ramps up at a faster rate. The UGATE starts switching when the ENSS voltage reaches 1.4V (Typ).

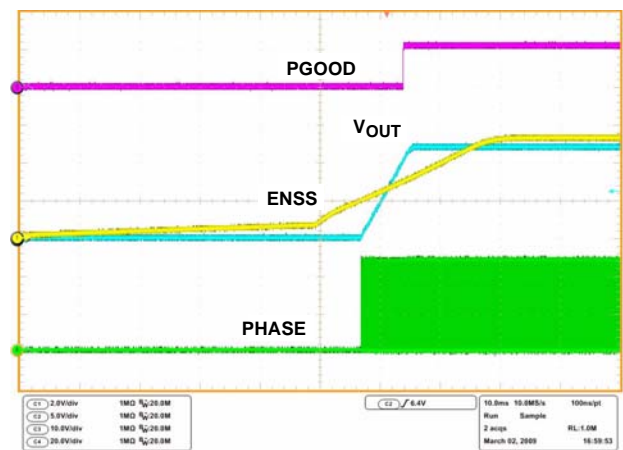

FIGURE 2. START-UP WAVEFORMS

Output Voltage Ripple

Figure 3 shows the ripple voltage on the output of the regulator at 5A load current.

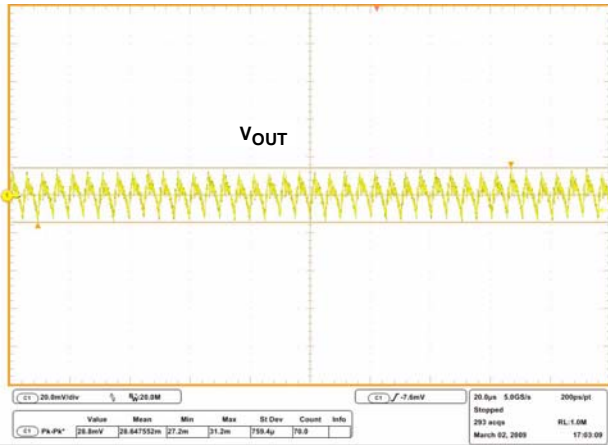

FIGURE 3. OUTPUT VOLTAGE RIPPLE @ I_{OUT} = 5A

Transient Responses

Figures 4, 5, and 6 show the response of the output when subjected to transient loading from 1A to 5A at 1A/μs (within continuous conduction mode).

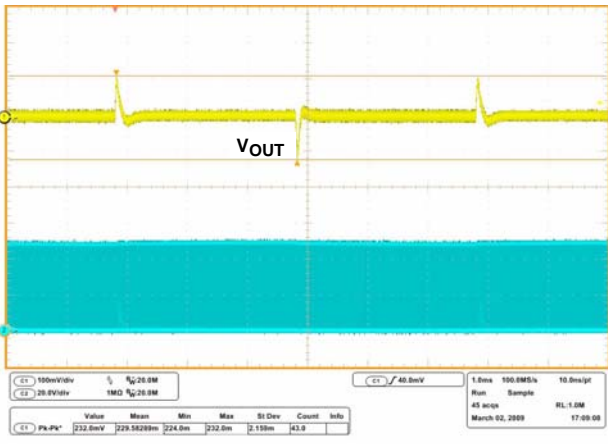

FIGURE 4. OUTPUT TRANSIENT

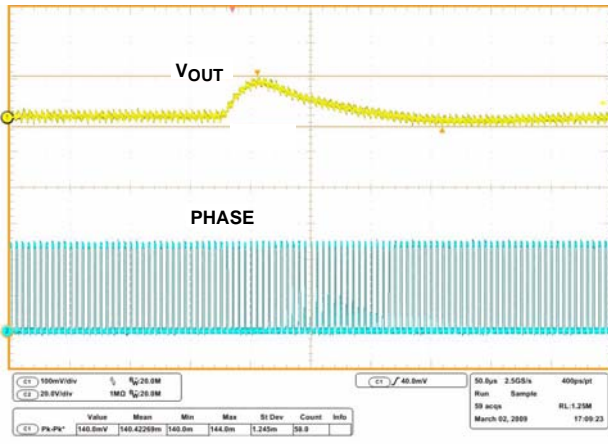

FIGURE 5. OUTPUT TRANSIENT

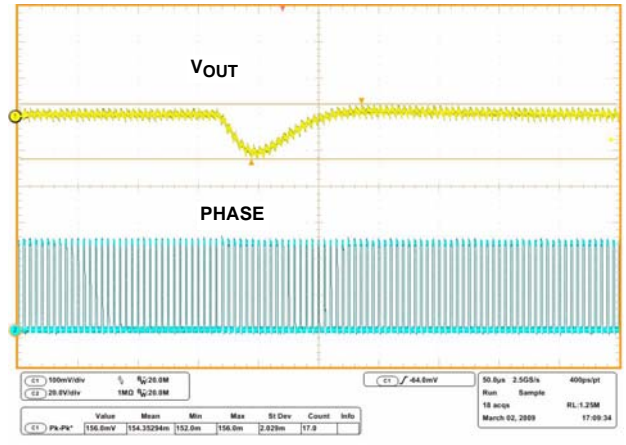

FIGURE 6. OUTPUT TRANSIENT

Figure 7 shows the response of the output when subjected to transient loading from 0.1A to 5A at 1A/μs (transition between continuous conduction mode and discontinuous conduction mode).

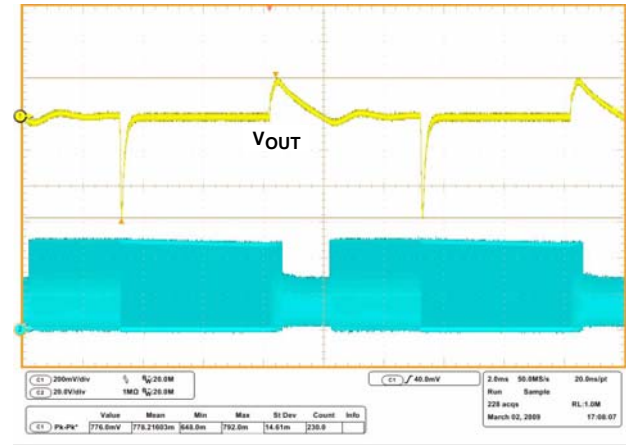

FIGURE 7. OUTPUT TRANSIENT

Efficiency and Line Regulation

The efficiency and the line regulation of the evaluation board with various input voltages are shown in Figures 8 and 9, respectively.

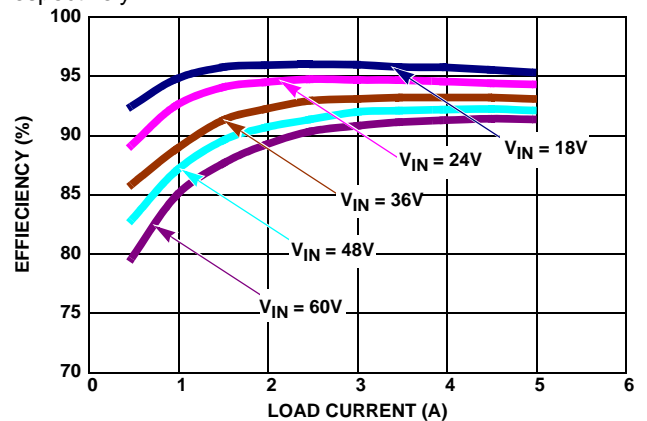

FIGURE 8. CONVERTER EFFICIENCY (V_{OUT} = 12V)

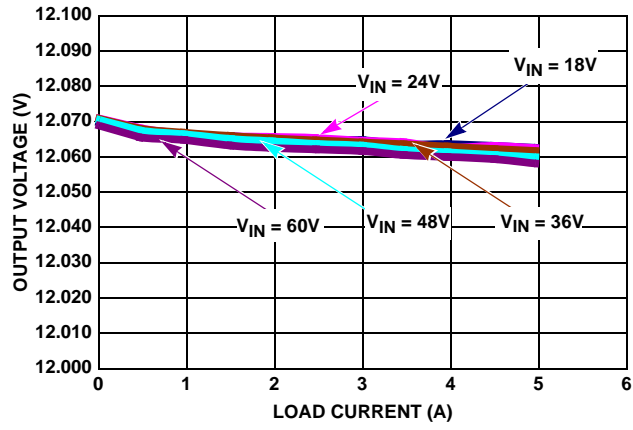
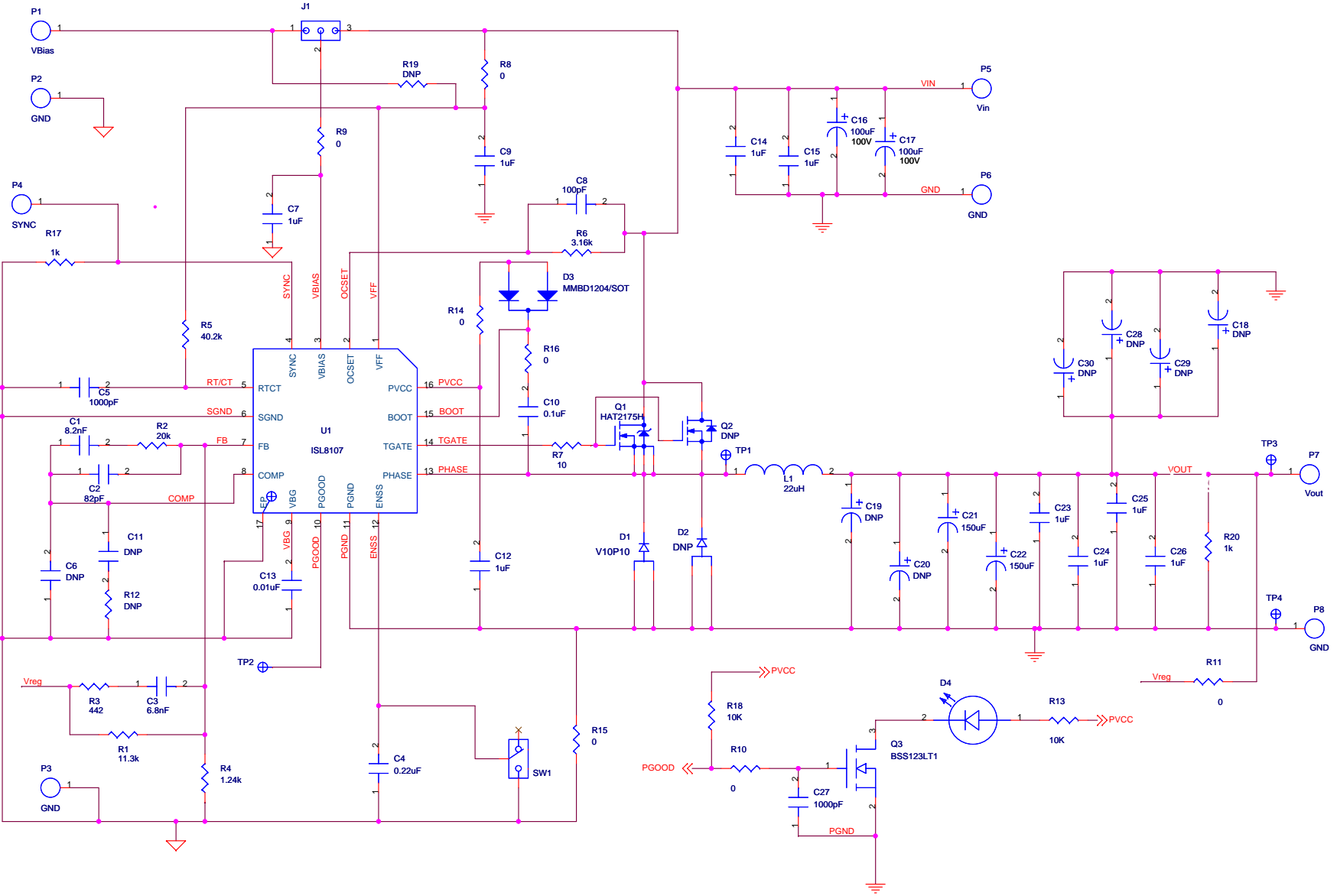

FIGURE 9. LINE REGULATION FOR $V_{OUT} = 12V$

ISL8107EVAL2Z Schematic



Application Note 1459

Bill of Materials

REFERENCE	QTY	PART NUMBER	DESCRIPTION	PACKAGE	VENDOR
U1	1	ISL8107IRZ	Single PWM Controller	16 Ld QFN	Intersil
Q1	1	HAT2175	100V N-Channel MOSFET	LFPAK	Renesas
Q3	1	BSS123LT1G	N-Channel MOSFET, 0.17A	SOT-23	On Semi.
D1	1	V10P10	100V Schottky Diode Rectifier	TO-277A	Vishay
D3	1	MMBD1204	100V Ultrafast Diode	SOT-23	Fairchild
D4	1	597-3311	LED Green	SMD1206	DIALIGHT
L1	1	HC9-220-R	22μH Power Inductor	SMD 12.9x13.2	Coiltronics
Q2, D2	0	DNP			
CAPACITORS					
C1	1		8200pF, 50V, X7R, 10%, Ceramic Capacitor	0603	Various
C2	1		82pF, 50V, COG, 10%, Ceramic Capacitor	0603	Various
C3	1		6800pF, 50V, X7R, 10%, Ceramic Capacitor	0603	Various
C4	1		0.22μF, 16V, X7R, 10%, Ceramic Capacitor	0603	Various
C5	1	GRM2195C2A102JA01D	1000pF, 100V, COG, 5%, Ceramic Capacitor	0805	Murata
C7, C9, C14, C15	4		1μF, 100V, X7R, 10%, Ceramic Capacitor	1210	Various
C8	1		100pF, 50V, COG, 10%, Ceramic Capacitor	0603	Various
C10	1		0.1μF, 50V, X7R, 10%, Ceramic Capacitor	0603	Various
C12, C23, C24, C25, C26	5		1μF, 25V, X5R, 10%, Ceramic Capacitor	0805	Various
C13	1		0.01μF, 50V, X7R, 10%, Ceramic Capacitor	0603	Various
C16, C17	2	100ME100PX	100μF, 100V, Aluminum Electrolytic Capacitor	RAD 12.5x20	Sanyo
C21, C22	2	20SEQP150M	150μF, 20V, OSCON Capacitor	RAD 10x13	Sanyo
C27	1		1000pF, 50V, X7R, 10%, Ceramic Capacitor	0603	Various
C6, C11, C18, C19, C20, C28, C29, C30	0	DNP			
RESISTORS					
R1	1		Resistor, 11.3kΩ, 1%, 1/10W	0603	Various
R2	1		Resistor, 20kΩ, 1%, 1/10W	0603	Various
R3	1		Resistor, 442Ω, 1%, 1/10W	0603	Various
R4	1		Resistor, 1.24kΩ, 1%, 1/10W	0603	Various
R5	1		Resistor, 40.2kΩ, 1%, 1/10W	0603	Various
R6	1		Resistor, 3.16kΩ, 1%, 1/10W	0603	Various
R7	1		Resistor, 10Ω, 1%, 1/10W	0603	Various
R8, R9, R10, R11, R14, R15, R16	7		0Ω Resistor, 1/10W	0603	Various
R13, R18	2		Resistor, 10kΩ, 5%, 1/10W	0603	Various
R17	1		Resistor, 1kΩ, 1%, 1/10W	0603	Various
R20	1		Resistor, 1kΩ, 1%, 1W	2512	Various
R12, R19	0	DNP			
OTHERS					
J1	1	68000-236-1X3	Connector Header		BERG/FCI
SW1	1	GT11MSCKE	SMD Toggle Switch		C&K
P1 through P8	8	1514-2	Turret Post		Keystone

ISL8107EVAL2Z Layout (Continued)

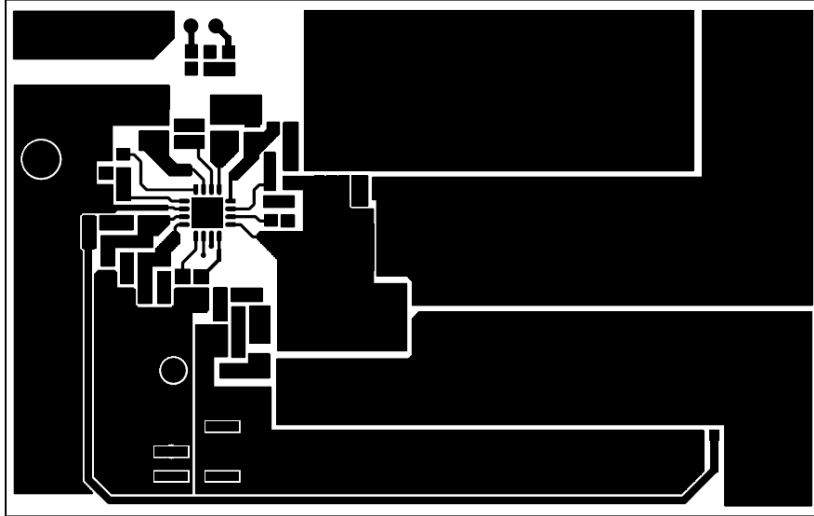

FIGURE 12. TOP LAYER

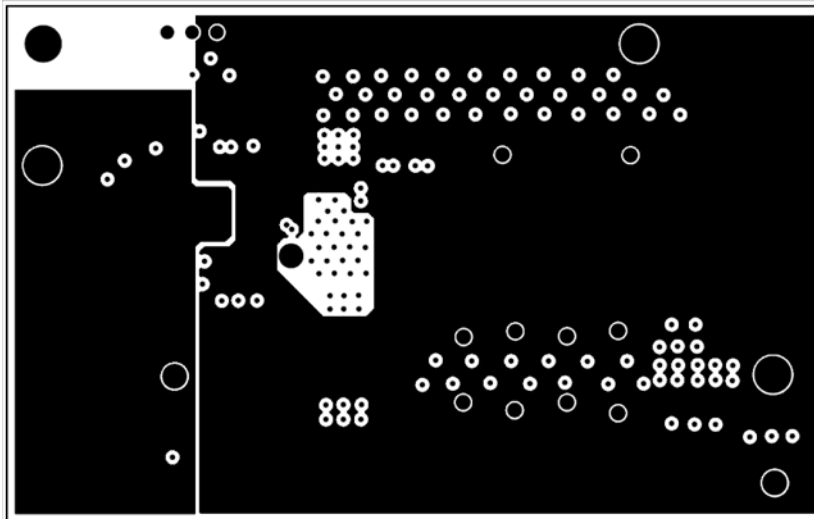

FIGURE 13. LAYER 2

ISL8107EVAL2Z Layout (Continued)

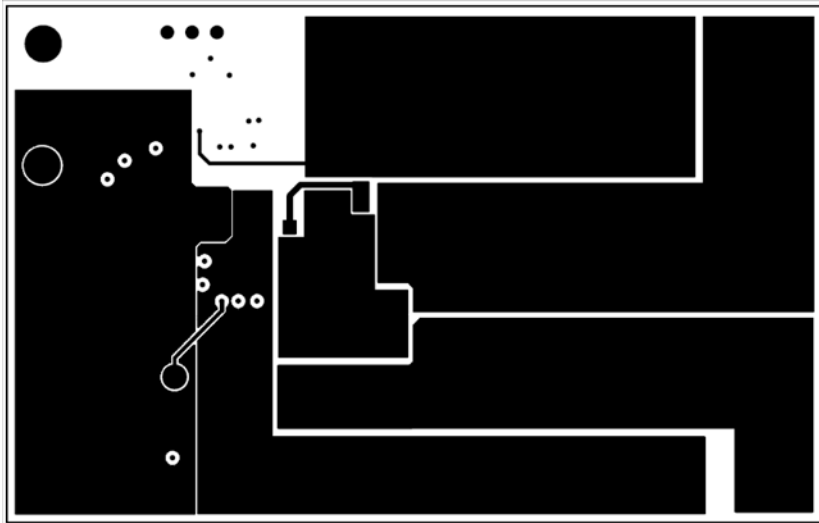

FIGURE 14. LAYER 3

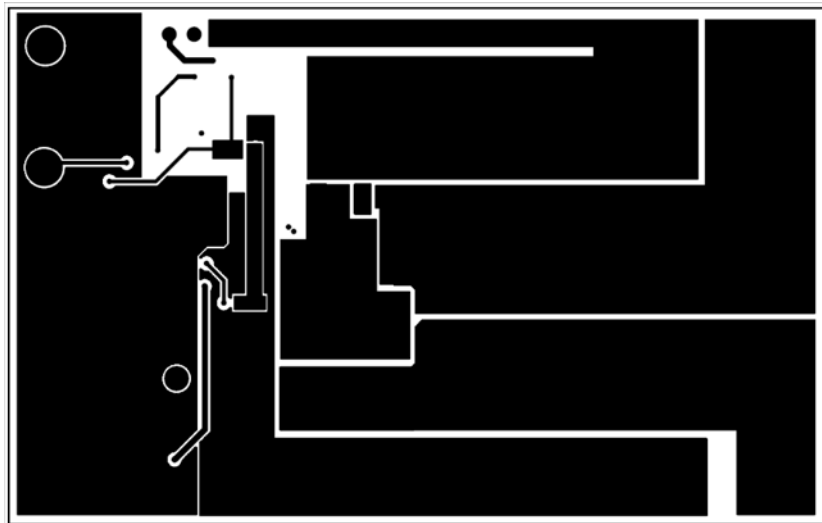

FIGURE 15. BOTTOM LAYER

ISL8107EVAL2Z Layout (Continued)

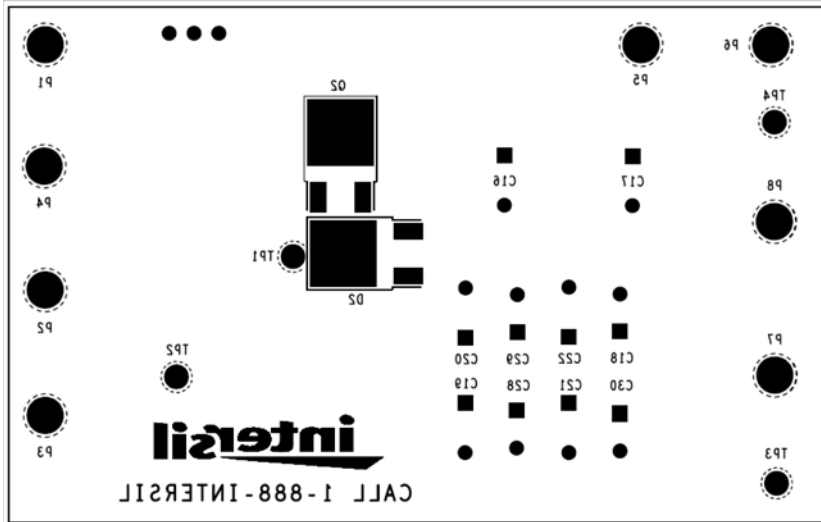

FIGURE 16. BOTTOM SILK SCREEN

Intersil Corporation reserves the right to make changes in circuit design, software and/or specifications at any time without notice. Accordingly, the reader is cautioned to verify that the Application Note or Technical Brief is current before proceeding.

For information regarding Intersil Corporation and its products, see www.intersil.com