

UG191: EZR32 Happy Gecko 434 MHz Wireless Starter Kit

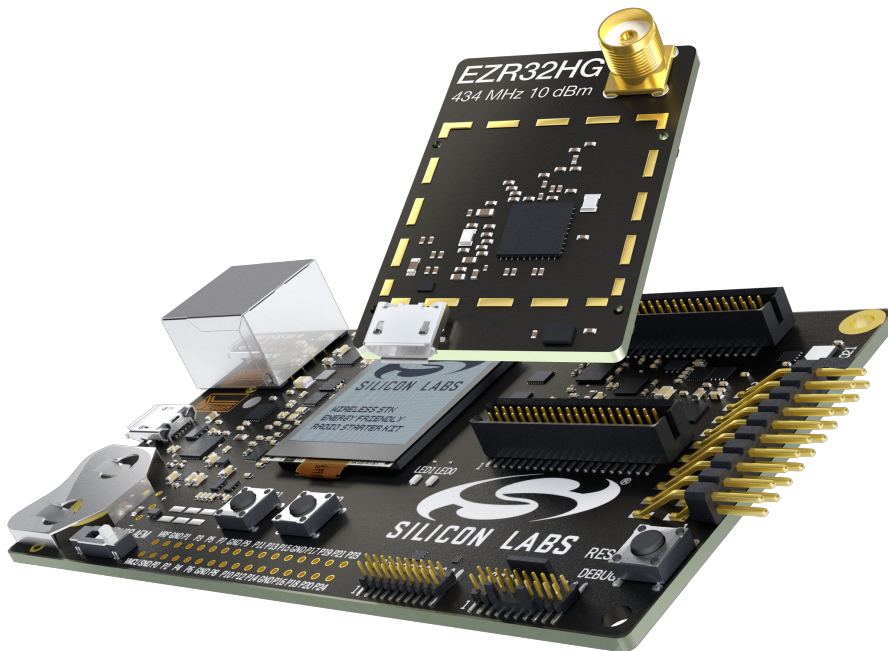

The SLWSTK6241A is an excellent starting point to get familiar with the EZR32™ Happy Gecko Wireless Microcontroller.

The Wireless Starter Kit Mainboard contains sensors and peripherals demonstrating some of the EZR32 Happy Gecko's many capabilities. The kit provides all necessary tools for developing a Silicon Labs wireless application.



KIT FEATURES

- Ethernet and USB connectivity
- Advanced Energy Monitor
- Packet Trace Interface support
- SEGGER J-Link on-board debugger
- Debug Multiplexer supporting external hardware as well as radio board
- Silicon Labs' Si7021 Relative Humidity and Temperature sensor
- Ultra low power 128x128 pixel Memory LCD
- User LEDs / Pushbuttons
- 20-pin 2.54 mm header for expansion boards
- Breakout pads for direct access to all radio I/O pins
- Power sources includes USB and CR2032 coin cell holder.

RADIO BOARD FEATURES

- EZR32 Happy Gecko Wireless MCU with 64 kB Flash and 8 kB RAM. (EZR32HG320F64R55G)
- SMA connector for RF
- USB Micro-B connector

SOFTWARE SUPPORT

- Simplicity Studio™
- Energy Profiler

1. Introduction

The SLWSTK6241A Wireless Starter Kit provides a complete development platform for Silicon Labs EZR32 Happy Gecko Wireless Microcontrollers.

The core of the SLWSTK6241A is the Wireless Starter Kit Mainboard which features an on-board J-Link debugger, an Advanced Energy Monitor (AEM) for real-time current and voltage monitoring, a Virtual COM port interface (VCOM), and access to the Packet Trace Interface (PTI).

The WSTK Mainboard is paired with an EZR32HG 434 MHz 10 dBm radio board that plugs directly into the mainboard. The radio board features the EZR32 itself and the RF interface. Please refer to the Reference Manual for the included radio boards for detailed specifications and RF performance figures.

All debug functionality, including AEM, VCOM and PTI, can also be used towards an external target instead of the included radio board.

To further enhance the WSTK usability, the WSTK Mainboard contains sensors and peripherals demonstrating some of the Wireless MCU's many capabilities.

1.1 Kit Contents

The following items are included in the box:

- 2x BRD4001A Wireless Starter Kit Mainboards
- 2x BRD4542B EZR32HG 434 MHz 10 dBm Radio Boards
- 2x 434 MHz antennas with SMA connector
- 2x CR2032 Lithium batteries
- 2x USB Type A <-> USB Mini-B cables
- 2x USB Type A <-> USB Micro-B cables
- 1x BRD8010A WSTK Debug Adapter

1.2 Getting Started

Detailed instructions for how to get started can be found on the Silicon Labs web pages:

<http://www.silabs.com/simplicity>

2. Kit Hardware Layout

The layout of the EZR32 Happy Gecko 434 MHz Wireless Starter Kit is shown below.

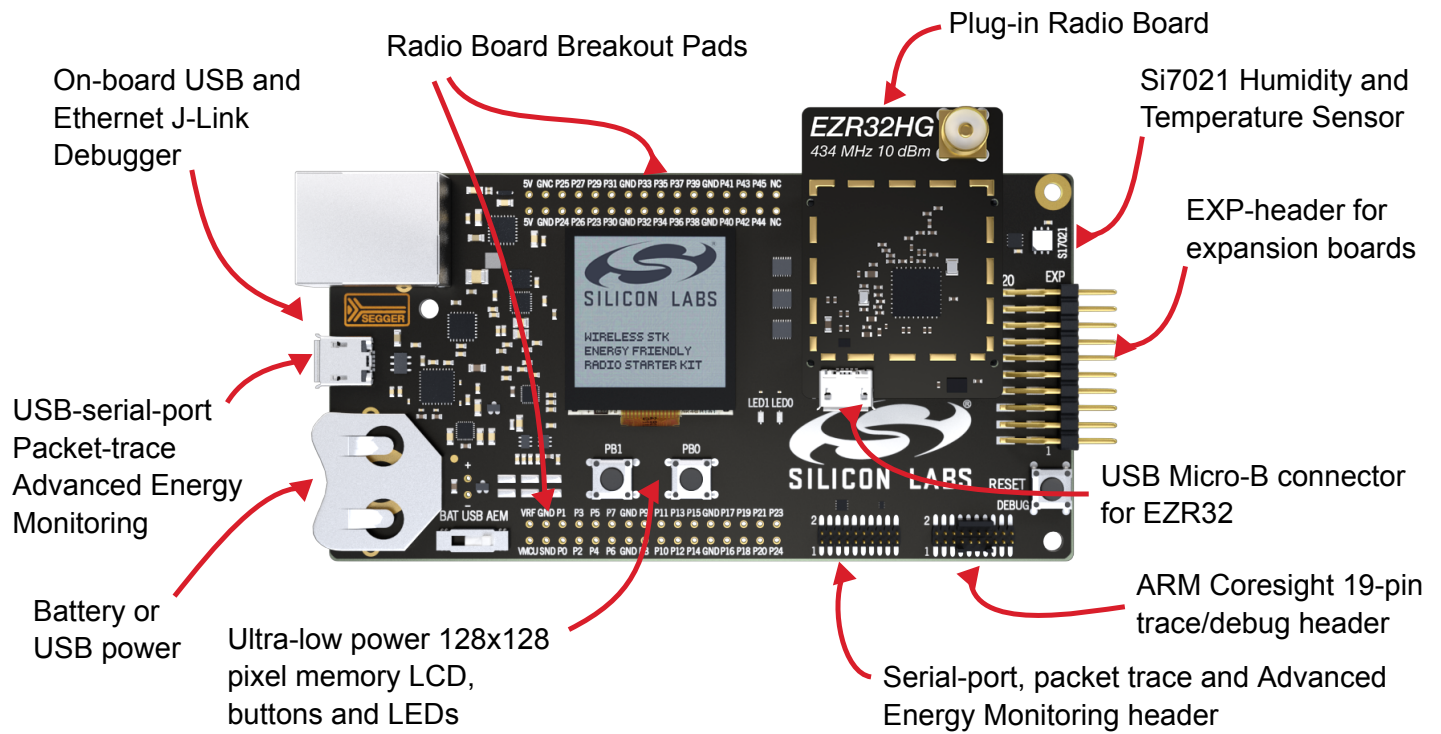

Figure 2.1. SLWSTK6241A Hardware Layout

3. Kit Block Diagram

An overview of the EZR32 Happy Gecko 434 MHz Wireless Starter Kit is shown in the figure below.

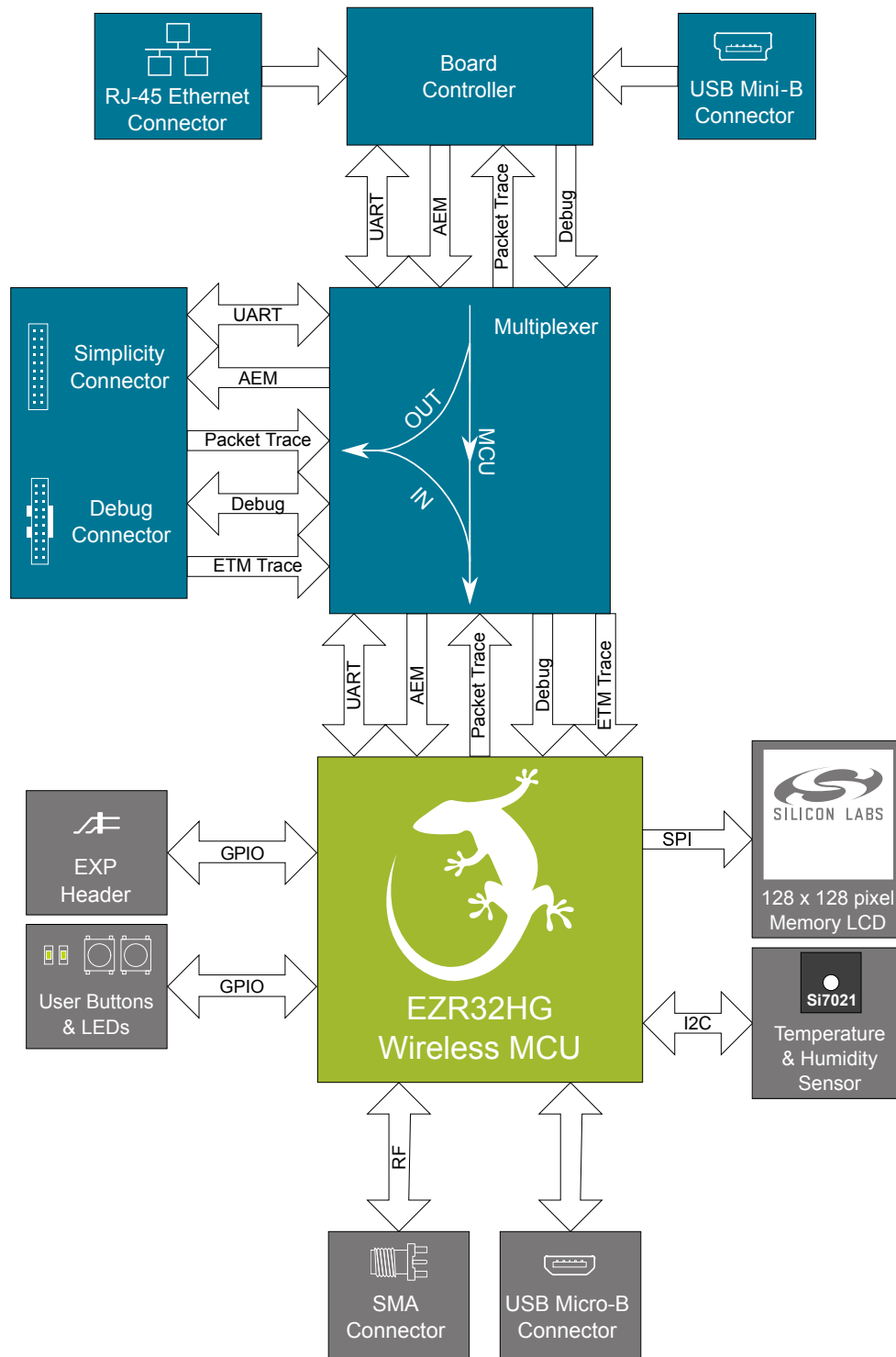

Figure 3.1. Kit Block Diagram

4. Connectors

This chapter gives you an overview of the Wireless Starter Kit Mainboard connectivity. The placement of the connectors can be seen in the figure below.

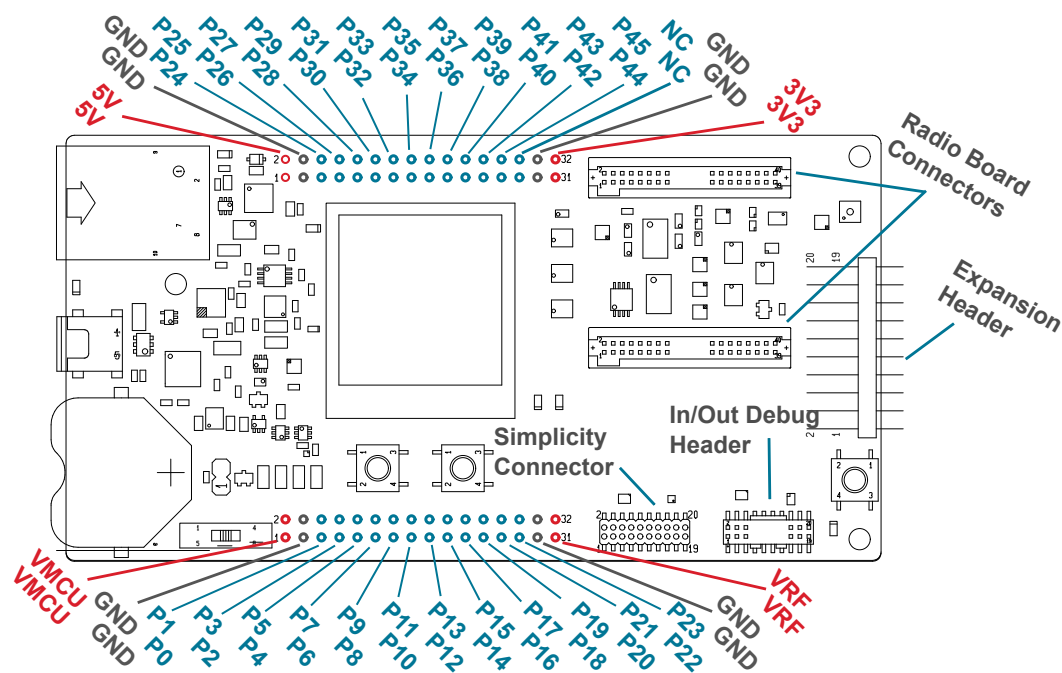

Figure 4.1. Mainboard Connector Layout

4.1 Breakout Pads

Most of the EZR32's pins are routed from the radio board to breakout pads at the top and bottom edges of the Wireless Starter Kit Mainboard. A 2.54 mm pitch pin header can be soldered on for easy access to the pins. The figure below shows you how the pins of the EZR32 maps to the pin numbers printed on the breakout pads. To see the available functions on each, please refer to the EZR32HG320F64R55G Data Sheet.

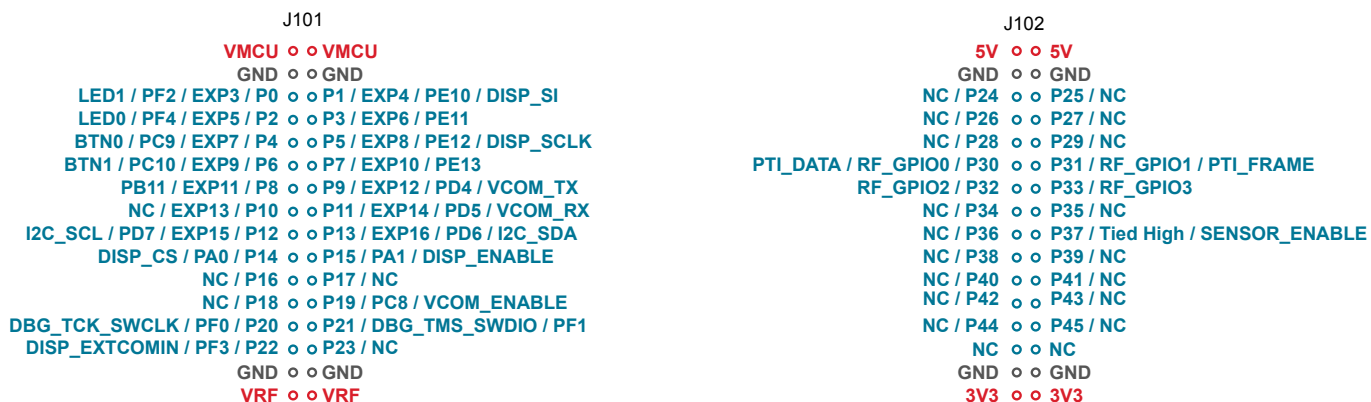

Figure 4.2. Radio Board Pin Mapping on Breakout Pads

4.2 Expansion Header

On the right hand side of the board an angled 20-pin expansion header is provided to allow connection of peripherals or plugin boards. The connector contains a number of I/O pins that can be used with most of the EZR32 Happy Gecko's features. Additionally, the VMCU, 3V3 and 5V power rails are also exported.

The connector follows a standard which ensures that commonly used peripherals such as an SPI, a UART and an I2C bus are available on fixed locations in the connector. The rest of the pins are used for general purpose IO. This allows the definition of expansion boards that can plug into a number of different Silicon Labs starter kits.

The figure below shows the pin assignment of the expansion header for the EZR32 Happy Gecko 434 MHz Wireless Starter Kit. Because of limitations in the number of available GPIO pins, some of the expansion header pins are shared with kit features.

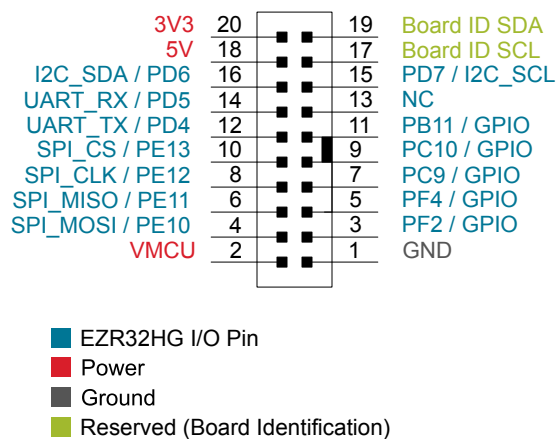

Figure 4.3. Expansion Header

4.2.1 Expansion header

Many pins on the EZR32HG are shared between the Expansion Header and other functions on the Wireless STK Mainboard. [Table 4.1 Expansion Header Pinout on page 6](#) includes an overview of the mainboard features that share pins with the Expansion Header.

Table 4.1. Expansion Header Pinout

Pin	Connection	EXP Header function	Shared feature	Peripheral mapping
20	3V3	Board controller supply		
18	5V	Board USB voltage		
16	PD6	I2C_SDA	SENSOR_I2C_SDA	I2C0_SDA #1
14	PD5	UART_RX	VCOM_RX_MISO	LEUART0_RX #0
12	PD4	UART_TX	VCOM_TX_MOSI	LEUART0_TX #0
10	PE13	SPI_CS		USART0_CS #0
8	PE12	SPI_SCLK	DISP_SCLK	USART0_CLK #0
6	PE11	SPI_MISO		USART0_RX #0
4	PE10	SPI_MOSI	DISP_MOSI	USART0_TX #0
2	VMCU	EZR32 voltage domain, included in AEM measurements.		
19	BOARD_ID_SDA	Connected to Board Controller for identification of add-on boards.		
17	BOARD_ID_SCL	Connected to Board Controller for identification of add-on boards.		
15	PD7	I2C_SCL	SENSOR_I2C_SCL	I2C0_SCL #1
13	Not connected			
11	PB11	GPIO		
9	PC10	GPIO	BTN1	
7	PC9	GPIO	BTN0	
5	PF4	GPIO	LED0	
3	PF2	GPIO	LED0	
1	GND	Ground		

4.3 Debug Connector

The Debug Connector serves multiple purposes based on the "debug mode" setting which can be configured in Simplicity Studio. When mode is set to "Debug IN", this connector allows an external debug emulator to be used with the radio board EZR32. When set to "Debug OUT", this connector allows the kit to be used as a debugger towards an external target. When set to "Debug MCU" (default), this connector is isolated from the debug interface of both the Board Controller and the on-board target device.

Because this connector is automatically switched to support the different operating modes, it is only available when the Board Controller is powered (J-Link USB cable connected). If debug access to the target device is required when the Board Controller is unpowered, this should be done by connecting directly to the appropriate breakout pins.

The pinout of the connector follows that of the standard ARM Cortex Debug+ETM 19-pin connector. The pinout is described in detail below. Even though the connector has support for both JTAG and ETM Trace, it does not necessarily mean that the kit or the on-board target device supports this.

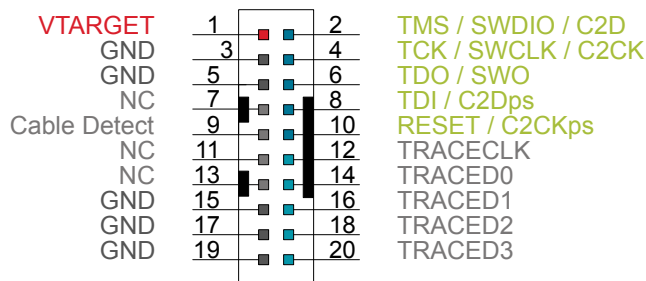

Figure 4.4. Debug Connector

Note: The pinout matches the pinout of an ARM Cortex Debug+ETM connector, but these are not fully compatible as pin 7 is physically removed from the Cortex Debug+ETM connector. Some cables have a small plug that prevent them from being used when this pin is present. If this is the case, remove the plug, or use a standard 2x10 1.27 mm straight cable instead.

Table 4.2. Debug Connector Pin Descriptions

Pin number(s)	Function	Description
1	VTARGET	Target voltage on the debugged application.
2	TMS / SDWIO / C2D	JTAG test mode select, Serial Wire data or C2 data
4	TCK / SWCLK / C2CK	JTAG test clock, Serial Wire clock or C2 clock
6	TDO/SWO	JTAG test data out or Serial Wire Output
8	TDI / C2Dps	JTAG test data in, or C2D "pin sharing" function
10	RESET / C2CKps	Target device reset, or C2CK "pin sharing" function
12	TRACECLK	Not connected
14	TRACED0	Not connected
16	TRACED1	Not connected
18	TRACED2	Not connected
20	TRACED3	Not connected
9	Cable detect	Connect to ground
11, 13	NC	Not connected
3, 5, 15, 17, 19	GND	Ground

Note: Although the on-board debugger and the Debug Connector supports JTAG, the EZR32HG-series of devices do not support JTAG.

4.4 Simplicity Connector

The Simplicity Connector featured on the Wireless Starter Kit Mainboard enables advanced debugging features such as the AEM, the Virtual COM port and the Packet Trace Interface to be used towards an external target. The pinout is illustrated in the figure below.

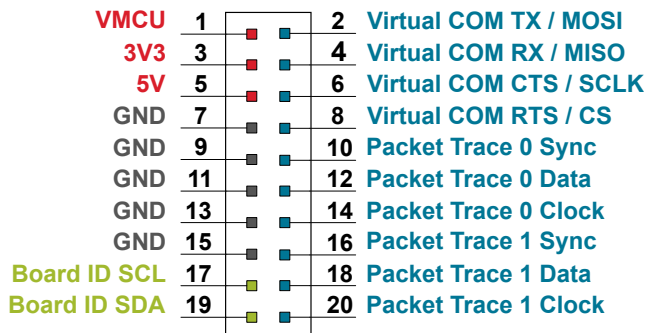

Figure 4.5. Simplicity Connector

Note: Current drawn from the VMCU voltage pin is included in the AEM measurements, while the 3V3 and 5V voltage pins are not. To monitor the current consumption of an external target with the AEM, unplug the WSTK Radio Board from the WSTK Mainboard to avoid that the Radio Board current consumption is added to the measurements.

Table 4.3. Simplicity Connector Pin Descriptions

Pin number(s)	Function	Description
1	VMCU	3.3 V power rail, monitored by the AEM
3	3V3	3.3 V power rail
5	5V	5 V power rail
2	VCOM_TX_MOSI	Virtual COM Tx/MOSI
4	VCOM_RX_MISO	Virtual COM Rx/MISO
6	VCOM_CTS_SCLK	Virtual COM CTS/SCLK
8	VCOM_RTS_CS	Virtual COM RTS/CS
10	PTI0_SYNC	Packet Trace 0 Sync
12	PTI0_DATA	Packet Trace 0 Data
14	PTI0_CLK	Packet Trace 0 Clock
16	PTI1_SYNC	Packet Trace 1 Sync
18	PTI1_DATA	Packet Trace 1 Data
20	PTI1_CLK	Packet Trace 1 Clock
17	EXT_ID_SCL	Board ID SCL
19	EXT_ID_SDA	Board ID SDA
7, 9, 11, 13, 15	GND	Ground

4.5 Debug Adapter

Included with the kit is one BRD8010A STK/WSTK Debug Adapter Board. This board is an adapter which plugs directly into the Debug Connector and the Simplicity Connector on the mainboard and combines selected functionality from these two to a smaller footprint 10-pin connector which is more suitable for space constrained designs.

For versatility, the Debug Adapter feature three different 10-pin debug connectors:

- Silicon Labs Mini Simplicity Connector
- ARM Cortex 10-pin Debug Connector
- Silicon Labs ISA3 Packet Trace

The ARM Cortex 10-pin Debug Connector follows the standard Cortex pin-out defined by ARM and allows the Starter Kit to be used to debug hardware designs that use this connector.

The ISA3 connector follows the same pin-out as the Packet Trace connector found on the Silicon Labs Ember Debug Adapter (ISA3). This allows the Starter Kit to be used to debug hardware designs that use this connector.

The Mini Simplicity Connector is designed to offer advanced debug features from the Starter Kit on a 10-pin connector:

- Serial Wire Debug (SWD) with SWO
- Packet Trace Interface (PTI)
- Virtual COM Port (VCOM)
- AEM Monitored voltage rail

Note: Packet Trace is only available on Wireless STK Mainboards. MCU Starter Kits do not support Packet Trace.

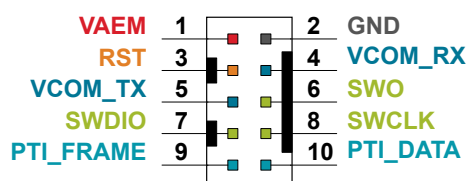

Figure 4.6. Mini Simplicity Connector

Table 4.4. Mini Simplicity Connector Pin Descriptions

Pin number	Function	Description
1	VAEM	Target voltage on the debugged application. Supplied and monitored by the AEM when power selection switch is in the "AEM" position.
2	GND	
3	RST	Reset
4	VCOM_RX	Virtual COM Rx
5	VCOM_TX	Virtual COM Tx
6	SWO	Serial Wire Output
7	SWDIO	Serial Wire Data
8	SWCLK	Serial Wire Clock
9	PTI_FRAME	Packet Trace Frame Signal
10	PTI_DATA	Packet Trace Data Signal

5. Power Supply and Reset

5.1 Radio Board Power Selection

The EZR32 on a Wireless Starter Kit can be powered by one of these sources:

- the debug USB cable;
- a 3V coin cell battery; or
- a USB regulator on the Radio Board (for devices with USB support only).

The power source for the radio board is selected with the slide switch in the lower left corner of the Wireless STK Mainboard. [Figure 5.1 Power Switch](#) on page 10 shows how the different power sources can be selected with the slide switch.

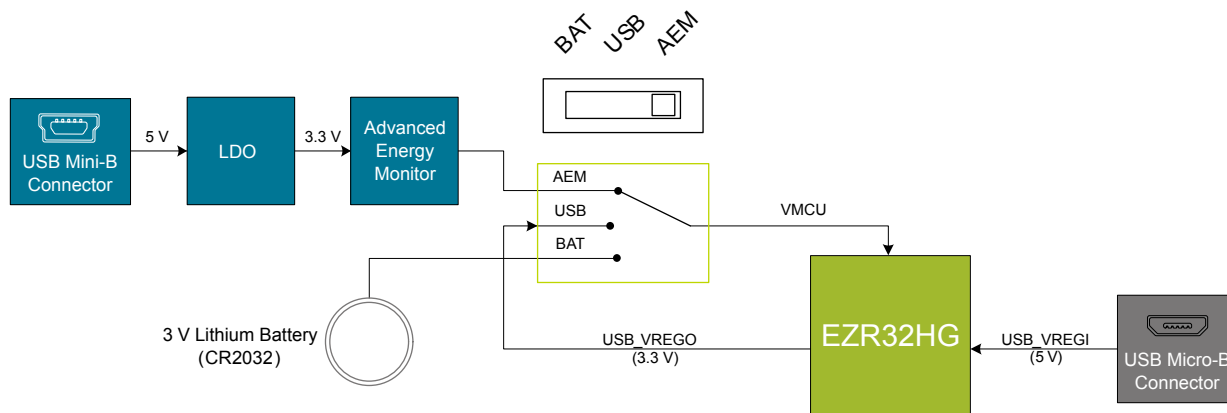

Figure 5.1. Power Switch

With the switch in the **AEM** position, a low noise 3.3 V LDO on the WSTK Mainboard is used to power the Radio Board. This LDO is again powered from the debug USB cable. The Advanced Energy Monitor is now also connected in series, allowing accurate high speed current measurements and energy debugging/profiling.

With the switch in the **USB** position, the integrated linear regulator in the EZR32 is used to power the radio board. This allows a USB device application where the Wireless MCU operates as a bus powered device.

Finally, with the switch in the **BAT** position, a 20 mm coin cell battery in the CR2032 socket can be used to power the device. With the switch in this position no current measurements are active. This is the recommended switch position when powering the radio board with an external power source.

Note: The current sourcing capabilities of a coin cell battery might be too low to supply certain wireless applications.

Note: The Advanced Energy Monitor can only measure the current consumption of the EZR32 when the power selection switch is in the **AEM** position.

5.2 Board Controller Power

The board controller is responsible for important features such as the debugger and the Advanced Energy Monitor, and is powered exclusively through the USB port in the top left corner of the board. This part of the kit resides on a separate power domain, so a different power source can be selected for the target device while retaining debugging functionality. This power domain is also isolated to prevent current leakage from the target power domain when power to the Board Controller is removed.

The board controller power domain is exclusively supplied by the J-Link USB cable, and is not influenced by the position of the power switch.

The kit has been carefully designed to keep the board controller and the target power domains isolated from each other as one of them powers down. This ensures that the target EZR32 device will continue to operate in the **USB** and **BAT** modes.

5.3 EZR32 Reset

The EZR32 Wireless MCU can be reset by a few different sources:

- A user pressing the RESET button.
- The on-board debugger pulling the #RESET pin low.
- An external debugger pulling the #RESET pin low.

In addition to the reset sources mentioned above, the Board Controller will also issue a reset to the EZR32 when booting up. This means that removing power to the Board Controller (plugging out the J-Link USB cable) will not generate a reset, but plugging the cable back in will, as the Board Controller boots up.

6. Peripherals

The starter kit has a set of peripherals that showcase some of the features of the EZR32.

Be aware that most EZR32 I/O routed to peripherals are also routed to the breakout pads. This must be taken into consideration when using the breakout pads for your application.

6.1 Push Buttons and LEDs

The kit has two user push buttons marked PB0 and PB1. They are connected directly to the EZR32, and are debounced by RC filters with a time constant of 1 ms. The buttons are connected to pins PC9 and PC10.

The kit also features two yellow LEDs marked LED0 and LED1, that are controlled by GPIO pins on the EZR32. The LEDs are connected to pins PF4 and PF2 in an active-high configuration.

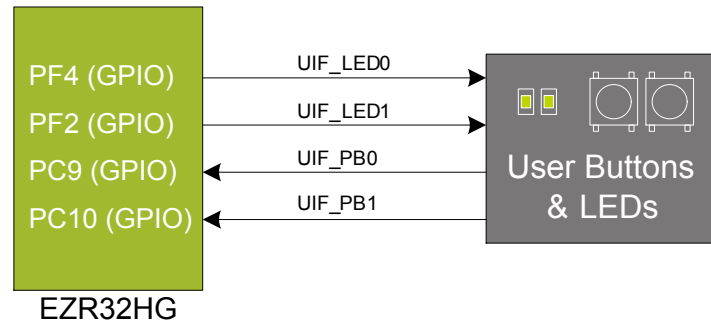

Figure 6.1. Buttons and LEDs

6.2 Memory LCD-TFT Display

A 1.28-inch SHARP Memory LCD-TFT is available on the kit to enable interactive applications to be developed. The display has a high resolution of 128 by 128 pixels, and consumes very little power. It is a reflective monochrome display, so each pixel can only be light or dark, and no backlight is needed in normal daylight conditions. Data sent to the display is stored in the pixels on the glass, which means no continuous refreshing is required to maintain a static image.

The display interface consists of an SPI-compatible serial interface and some extra control signals. Pixels are not individually addressable, instead data is sent to the display one line (128 bits) at a time.

The Memory LCD-TFT display is shared with the kit Board Controller, allowing the Board Controller application to display useful information when the user application is not using the display. The user application always controls ownership of the display with the DISP_ENABLE signal:

- DISP_ENABLE = LOW: The Board Controller has control of the display
- DISP_ENABLE = HIGH: The user application (EZR32) has control of the display

Power to the display is sourced from the target application power domain when the EZR32 controls the display, and from the Board Controller's power domain when the DISP_ENABLE line is low. Data is clocked in on DISP_SI when DISP_CS is high, and the clock is sent on DISP_SCLK. The maximum supported clock speed is 1.1 MHz.

DISP_COM is the "COM Inversion" line. It must be pulsed periodically to prevent static build-up in the display itself. Please refer to the display application information for details on driving the display:

<http://www.sharpmemorylcd.com/1-28-inch-memory-lcd.html>

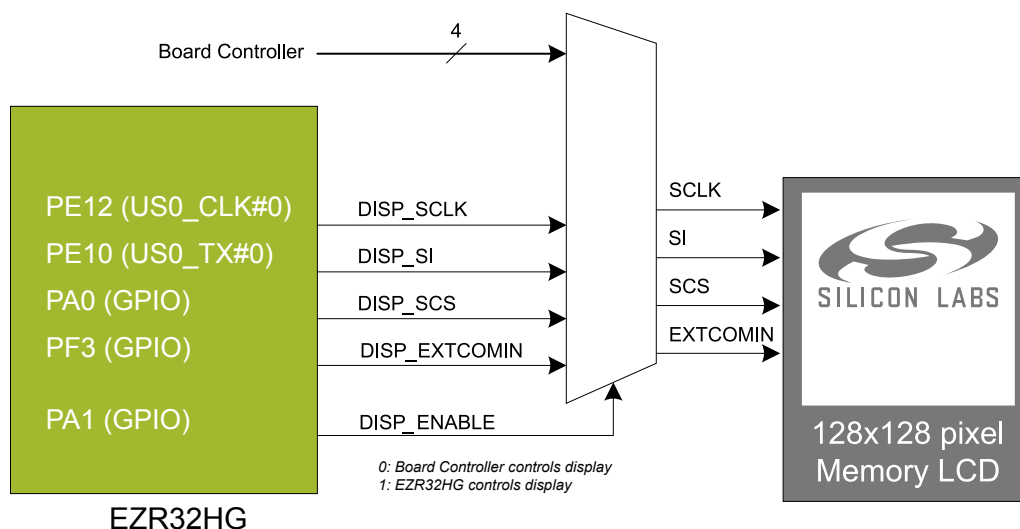

Figure 6.2. 128x128 Pixel Memory LCD

6.3 Si7021 Relative Humidity and Temperature Sensor

The Si7021 I²C relative humidity and temperature sensor is a monolithic CMOS IC integrating humidity and temperature sensor elements, an analog-to-digital converter, signal processing, calibration data, and an I²C Interface. The patented use of industry-standard, low-K polymeric dielectrics for sensing humidity enables the construction of low-power, monolithic CMOS Sensor ICs with low drift and hysteresis, and excellent long term stability.

The humidity and temperature sensors are factory-calibrated and the calibration data is stored in the on-chip non-volatile memory. This ensures that the sensors are fully interchangeable, with no recalibration or software changes required.

The Si7021 is available in a 3x3 mm DFN package and is reflow solderable. It can be used as a hardware- and software-compatible drop-in upgrade for existing RH/ temperature sensors in 3x3 mm DFN-6 packages, featuring precision sensing over a wider range and lower power consumption. The optional factory-installed cover offers a low profile, convenient means of protecting the sensor during assembly (e.g., reflow soldering) and throughout the life of the product, excluding liquids (hydrophobic/oleophobic) and particulates.

The Si7021 offers an accurate, low-power, factory-calibrated digital solution ideal for measuring humidity, dew-point, and temperature, in applications ranging from HVAC/R and asset tracking to industrial and consumer platforms.

The I²C bus used for the Si7021 is shared with the Expansion Header. The temperature sensor is normally isolated from the I²C line. To use the sensor, SENSOR_ENABLE (tied high) must be set high. When enabled, the sensor's current consumption is included in the AEM measurements.

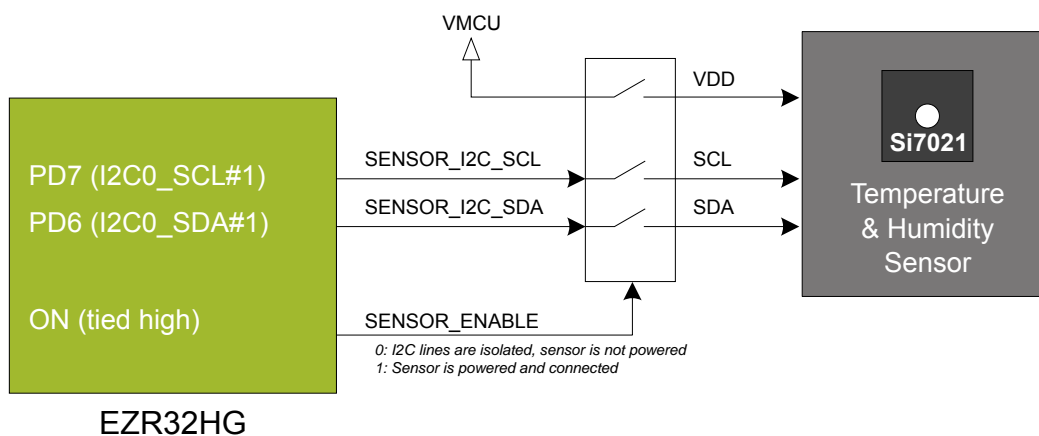

Figure 6.3. Si7021 Relative Humidity and Temperature Sensor

Please refer to the Silicon Labs web pages for more information: <http://www.silabs.com/humidity-sensors>

6.4 USB Micro-B Connector

The BRD4542B radio board is equipped with a USB Micro-B connector that is connected directly to the EZR32 Happy Gecko. [Figure 6.4 Radio Board USB Connector on page 15](#) shows how the USB lines are connected to the EZR32.

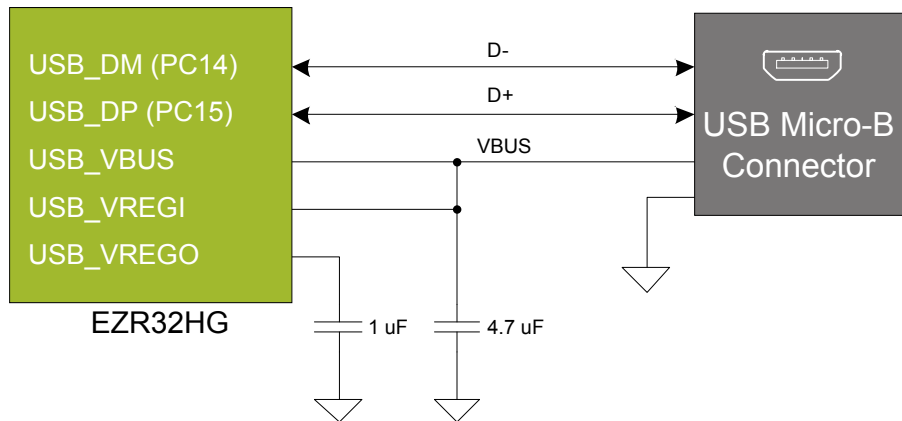

Figure 6.4. Radio Board USB Connector

6.5 Virtual COM Port

An asynchronous serial connection to the [board controller](#) is provided for application data transfer between a host PC and the target EZR32. This eliminates the need for an external serial port adapter.

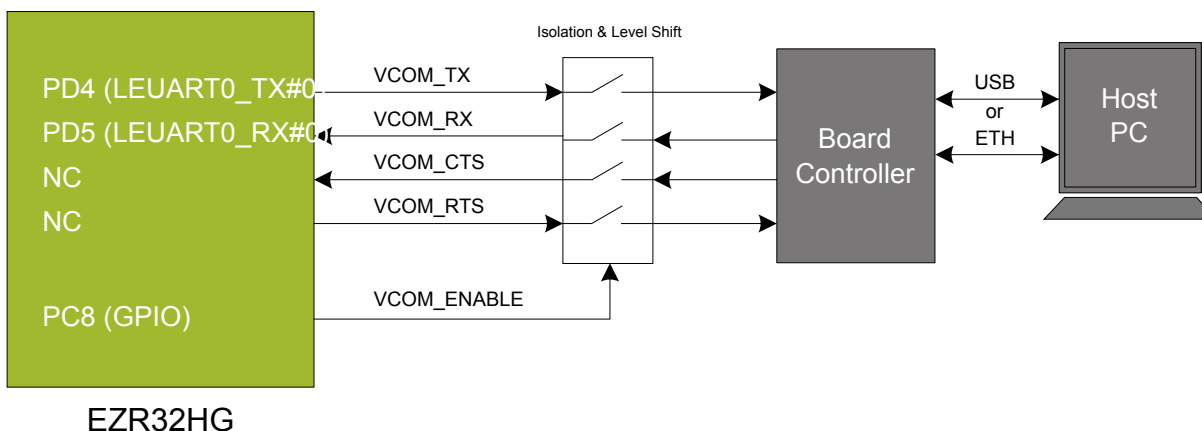

Figure 6.5. Virtual COM Port Interface

The Virtual COM port consists of a physical UART between the target device and the board controller, and a logical function in the board controller that makes the serial port available to the host PC over USB or Ethernet. The UART interface consists of four pins and an enable signal.

Table 6.1. Virtual COM Port Interface Pins

Signal	Description
VCOM_TX	Transmit data from the EZR32 to the board controller
VCOM_RX	Receive data from the board controller to the EZR32
VCOM_CTS	Clear to Send hardware flow control input, asserted by the board controller when it is ready to receive more data
VCOM_RTS	Request to Send hardware flow control output, asserted by the EZR32 when it is ready to receive more data
VCOM_ENABLE	Enables the VCOM interface, allowing data to pass through to the board controller.

The parameters of the serial port, such as baud rate or flow control, can be configured using the [admin console](#). The default settings depends on which radio board is used with the Wireless Starter Kit Mainboard. Please see [10. Device Connectivity](#) for more details.

Note: The VCOM port is only available when the board controller is powered, which requires the J-Link USB cable to be inserted.

7. Board Controller

The Wireless Starter Kit Mainboard contains a microcontroller separate from the EZR32 Happy Gecko that is responsible for some of the advanced kit features provided. This microcontroller is referred to as the "Board Controller", and is not programmable by the user. The board controller acts as an interface between the host PC and the target device on the radio board, as well as handling some house-keeping functions on the board.

Some of the kit features actively managed by the board controller are:

- The [On-board Debugger](#), which can flash and debug both on-board and external targets.
- The [Advanced Energy Monitor](#), which provides real-time energy profiling of the user application.
- The Packet Trace Interface, which is used in conjunction with PC software to provide detailed insight into an active radio network.
- The [Virtual COM Port](#) and [Virtual UART](#) interfaces, which provide ways to transfer application data between the host PC and the target processor.
- The [Admin Console](#), which provides configuration of the various board features.

Silicon Labs publishes updates to the board controller firmware in form of firmware upgrade packages. These updates may enable new features or fix issues. See [11.2 Firmware Upgrades](#) for details on firmware upgrade.

7.1 Admin Console

The admin console is a command line interface to the board controller on the kit. It provides functionality for configuring the kit behavior and retrieving configuration and operational parameters.

■ Connecting

The SLWSTK6241A must be connected to Ethernet using the Ethernet connector in the top left corner of the mainboard for the admin console to be available. See [• Ethernet Interface](#) for details on the Ethernet connectivity.

Connect to the Admin Console by opening a telnet connection to the kit's IP address, port number 4902.

When successfully connected, a `wstk>` prompt is displayed.

■ Built-in Help

The admin console has a built in help system which is accessed by the `help` command. The `help` command will print a list of all top level commands:

```
WSTK> help
***** Root commands *****
aem          AEM commands  [ calibrate, current, dump, ... ]
boardid      Commands for board ID probe.  [ list, probe ]
dbg          Debug interface status and control  [ info, mode,]
dch          Datachannel control and info commands  [ info ]
discovery    Discovery service commands.
net          Network commands.  [ dnslookup, geoprobe, ip ]
pti          Packet trace interface status and control  [ config, disable, dump, ... ]
quit        Exit from shell
sys          System commands  [ nickname, reset, scratch, ... ]
target       Target commands.  [ button, flashwrite, go, ... ]
time        Time Service commands  [ client, server ]
user        User management functions  [ login,]
```

The `help` command can be used in conjunction with any top level command to get a list of sub-commands with description. For example, `pti help` will print a list of all available sub-commands of `pti`:

```
WSTK> pti help
***** pti commands *****
config       Configure packet trace
disable      Disable packet trace
dump         Dump PTI packets to the console as they come
enable       Enable packet trace
info         Packet trace state information
```

This means that running `pti enable` will enable packet trace.

■ Command Examples

PTI Configuration

```
pti config 0 efruart 1600000
```

Configures PTI to use the "EFRUART" mode at 1.6 Mb/s.

Serial Port Configuration

```
serial config vcom handshake enable
```

Enables hardware handshake on the VCOM UART connection.

8. Advanced Energy Monitor

8.1 Introduction

Any embedded developer seeking to make his embedded code spend as little energy as the underlying architecture supports, needs tools to easily and quickly discover inefficiencies in the running application.

This is what the Simplicity Energy Profiler is designed to do. It will in real-time graph and log current as a function of time while correlating this to the actual target application code running on the EZR32. There are multiple features in the profiler software that allows for easy analysis, such as markers and statistics on selected regions of the current graph or aggregate energy usage by different parts of the application.

8.2 Theory of Operation

The Advanced Energy Monitor (AEM) circuitry on the board is capable of measuring current signals in the range of 0.1 μA to 95 mA, which is a dynamic range of almost 120 dB. It can do this while maintaining approximately 10 kHz of current signal bandwidth. This is accomplished through a combination of a highly capable current sense amplifier, multiple gain stages and signal processing within the kit's board controller before the current sense signal is read by a host computer for display and/or storage.

The current sense amplifier measures the voltage drop over a small series resistor, and the gain stage further amplifies this voltage with two different gain settings to obtain two current ranges. The transition between these two ranges occurs around 250 μA .

The current signal is combined with the target processor's Program Counter (PC) sampling by utilizing a feature of the ARM CoreSight debug architecture. The ITM (Instrumentation Trace Macrocell) block can be programmed to sample the MCU's PC at periodic intervals (50 kHz) and output these over SWO pin ARM devices. When these two data streams are fused and correlated with the running application's memory map, an accurate statistical profile can be built, that shows the energy profile of the running application in real-time.

At kit power-up or on a power-cycle, and automatic AEM calibration is performed. This calibration compensates for any offset errors in the current sense amplifiers.

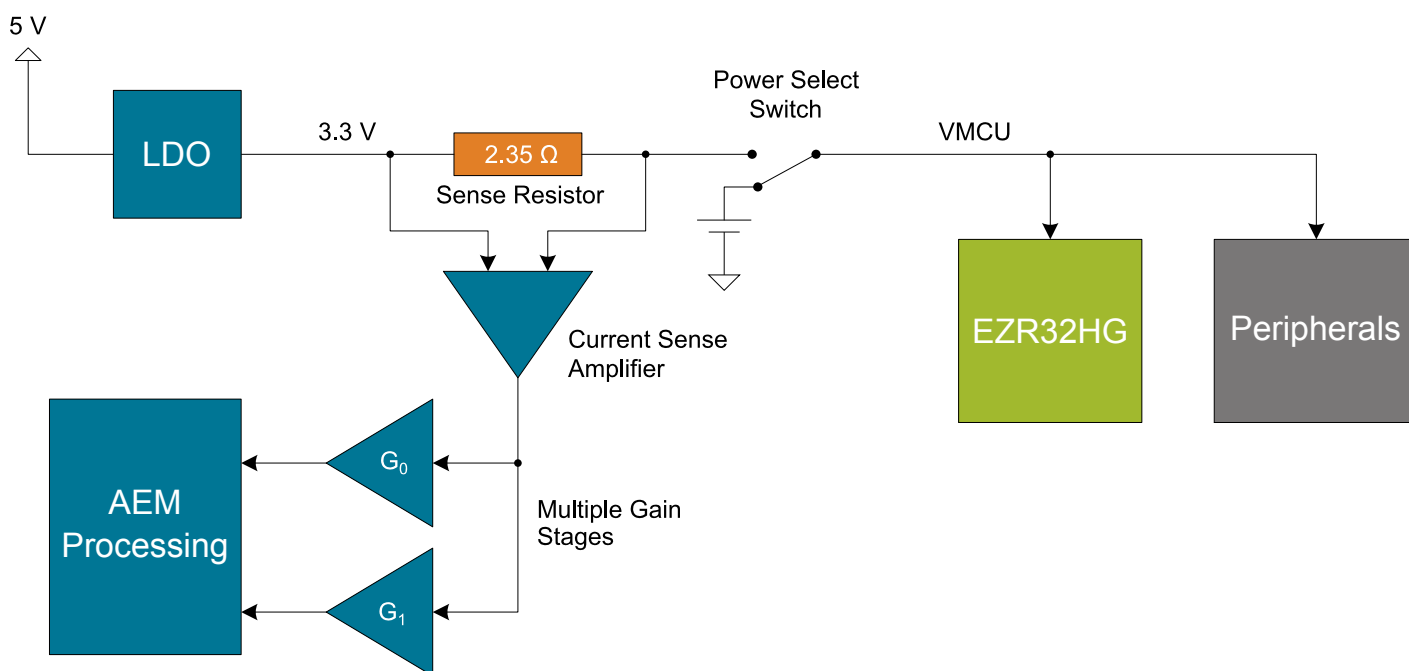

Figure 8.1. Advanced Energy Monitor

8.3 AEM Accuracy and Performance

The AEM is capable of measuring currents in the range of 0.1 μA to 95 mA. For currents above 250 μA , the AEM is accurate within 0.1 mA. When measuring currents below 250 μA , the accuracy increases to 1 μA . Even though the absolute accuracy is 1 μA in the sub 250 μA range, the AEM is able to detect changes in the current consumption as small as 100 nA.

The AEM current sampling rate is 10 kHz.

Note: The AEM circuitry only works when the kit is powered and the power switch is in the AEM position.

8.4 Usage

The AEM data is collected by the board controller and can be displayed by the Energy Profiler, available through Simplicity Studio. By using the Energy Profiler, current consumption and voltage can be measured and linked to the actual code running on the EZR32 in realtime.

9. On-Board Debugger

The SLWSTK6241A contains an integrated debugger, which can be used to download code and debug the EZR32. In addition to programming the EZR32 on the kit, the debugger can also be used to program and debug external Silicon Labs EFM32, EFM8, EZR32 and EFR32 devices.

The debugger supports three different debug interfaces used with Silicon Labs devices:

- Serial Wire Debug, is used with all EFM32, EFR32 and EZR32 devices
- JTAG, which can be used with some newer EFR32 and EFM32 devices
- C2 Debug, which is used with EFM8 devices

In order for debugging to work properly, make sure you have the appropriate debug interface selected that works with your device. The debug connector on the board supports all three of these modes.

9.1 Host Interfaces

The SLWSTK6241A supports connecting to the on-board debugger using either Ethernet or USB.

Many tools support connecting to a debugger using either USB or Ethernet. When connected over USB, the kit is identified by its J-Link serial number. When connected over Ethernet, the kit is normally identified by its IP address. Some tools also support using the serial number when connecting over Ethernet, this typically require the computer and the kit to be on the same subnet for the discovery protocol (using UDP broadcast packets) to work.

USB Interface

The USB interface is available whenever the mini-B USB connector on the left hand side of the kit is connected to a computer.

Ethernet Interface

The Ethernet interface is available when the kit's Ethernet connector in the top left corner is connected to a network. Normally, the kit will receive an IP address from a local DHCP server, and the IP address is printed on the LCD display. If your network does not have a DHCP server, you need to connect to the kit via USB and set the IP address manually using Simplicity Studio, Simplicity Commander or J-Link Configurator.

For the Ethernet connectivity to work, the kit must still be powered through the mini-B USB connector. See [5.2 Board Controller Power](#) for details.

Serial Number Identification

All Silicon Labs kits have a unique J-Link serial number which can identifies the kit to PC applications. This number is 9 digits, and is normally on the form 44xxxxxxxx.

The J-Link serial number is normally printed at the bottom of the kit LCD display.

9.2 Debug Modes

Programming external devices is done by connecting to a target board through the provided Debug IN/OUT Connector, and by setting the debug mode to **[Out]**. The same connector can also be used to connect an external debugger to the EZR32 Wireless MCU on the kit, by setting the debug mode to **[In]**. A summary of the different supported debug modes is given in [9.2 Debug Modes](#).

Selecting the active debug mode is done with a drop-down menu in the Kit Manager tool in Simplicity Studio.

Debug MCU: In this mode the on-board debugger is connected to the EZR32 on the SLWSTK6241A.

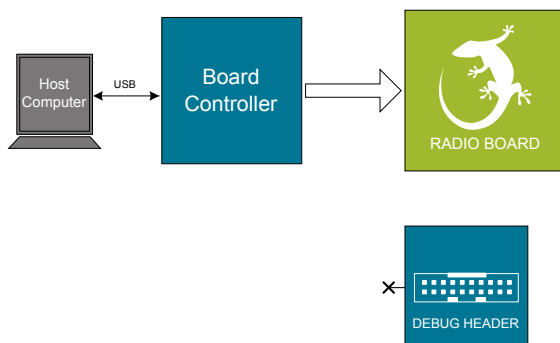

Figure 9.1. Debug MCU

Debug OUT: In this mode, the on-board debugger can be used to debug a supported Silicon Labs device mounted on a custom board.

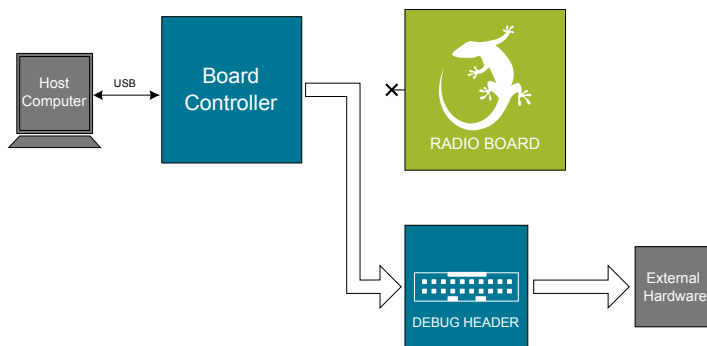

Figure 9.2. Debug OUT

Debug IN: In this mode, the on-board debugger is disconnected, and an external debugger can be connected to debug the EZR32 on the SLWSTK6241A.

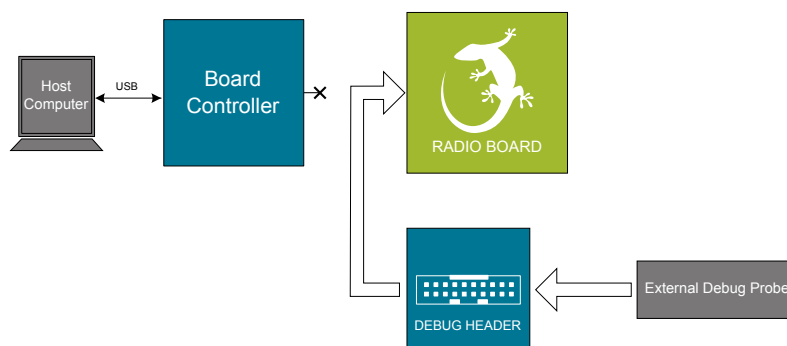

Figure 9.3. Debug IN

Note: For "Debug IN" to work, the board controller on the kit must be powered through the USB connector.

9.3 Debugging During Battery Operation

When the EZR32 is powered by battery and the J-Link USB is still connected, the on-board debug functionality is available. If the USB power is disconnected, the Debug In mode will stop working.

If debug access is required when the target is running of another energy source, such as a battery, and the board controller is powered down, the user should make direct connections to the GPIO used for debugging. This can be done by connecting to the appropriate pins of the breakout pads. Some Silicon Labs kits provide a dedicated pin header for this purpose.

10. Device Connectivity

The SLWSTK6241A provides several convenient ways to communicate with a target application without soldering or using external hardware.

10.1 Virtual COM Port

When the target device drives the VCOM_ENABLE (PC8) signal high, a communication line to the Board Controller is enabled. The target can then communicate to the host computer via the Board Controller using LEUART0, Location 0 (TX pin PD4, RX pin PD5).

When enabling VCOM, the Board Controller makes communication to the host computer possible on the following interfaces:

- Virtual USB serial port using a CDC driver.
- TCP/IP, by connecting to the Wireless STK on port 4901 with a Telnet client.

Note: Only one of these can be used at the same time, meaning that if a socket is connected to port 4901, no data can be sent or received on the USB COM port.

10.2 Virtual UART

The Virtual UART port outputs data that the target application outputs over SWO, ITM channel 0.

11. Kit Manager and Upgrades

The Kit Manager is a program that comes with Simplicity Studio. It can perform various kit and EZR32 specific tasks.

11.1 Kit Manager Operation

This utility gives the ability to program the EZR32, upgrade the kit, lock and unlock devices and more. Some of the features will only work with Silicon Labs kits, while other will work with a generic J-Link debugger connected.

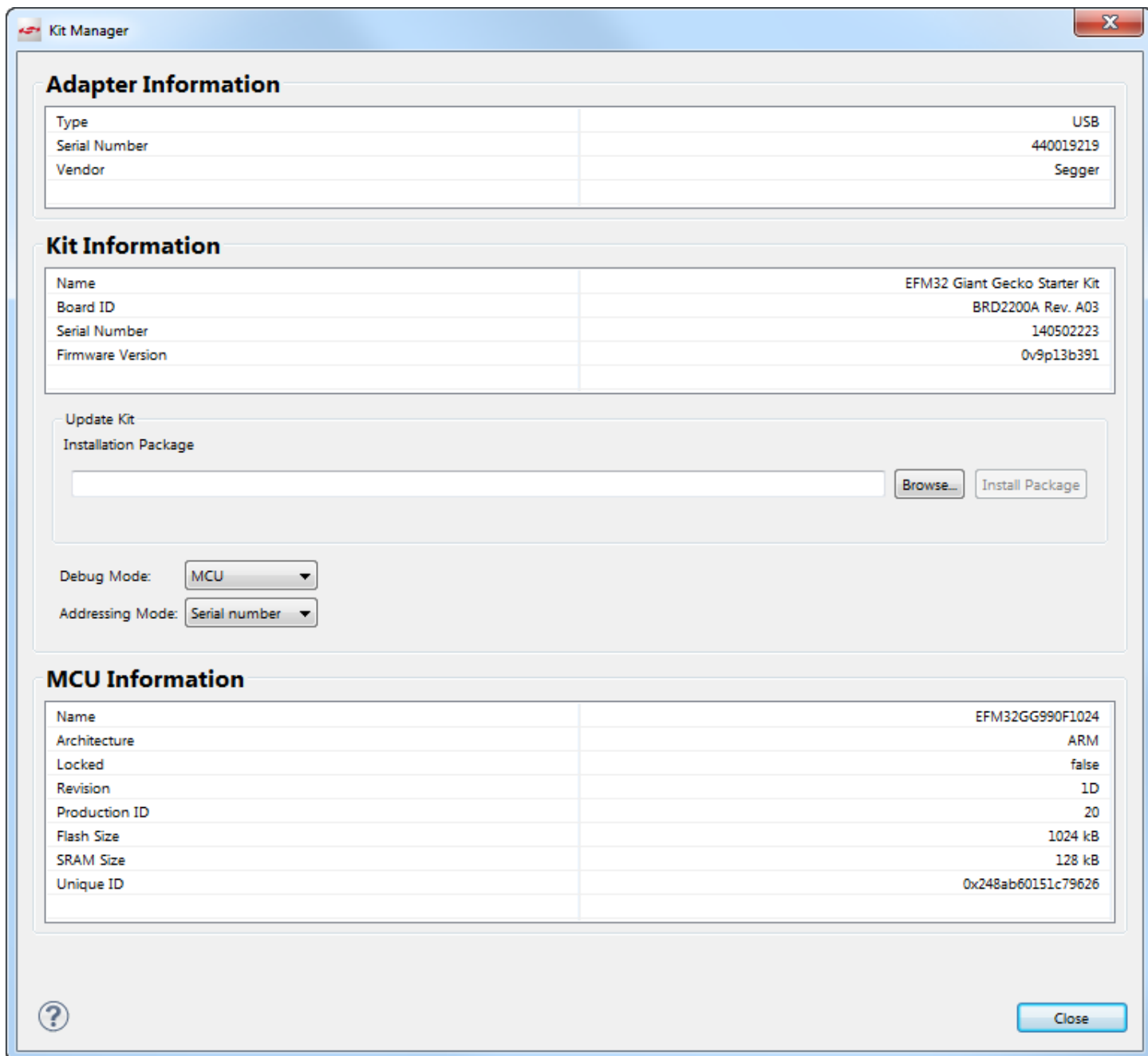

Figure 11.1. Kit Manager

11.2 Firmware Upgrades

Upgrading the kit firmware is done through Simplicity Studio. Simplicity Studio will automatically check for new updates on startup.

You can also use the Kit Manager for manual upgrades. Click the **[Browse]** button in the **[Update Kit]** section to select the correct file ending in ".emz". Then, click the **[Install Package]** button.

12. Schematics, Assembly Drawings and BOM

The schematics, assembly drawings and bill of materials (BOM) for the hardware included in the EZR32 Happy Gecko 434 MHz Wireless Starter Kit are available through Simplicity Studio when the kit documentation package has been installed.

13. Kit Revision History and Errata

13.1 Revision History

The kit revision can be found printed on the box label of the kit, as outlined in the figure below.

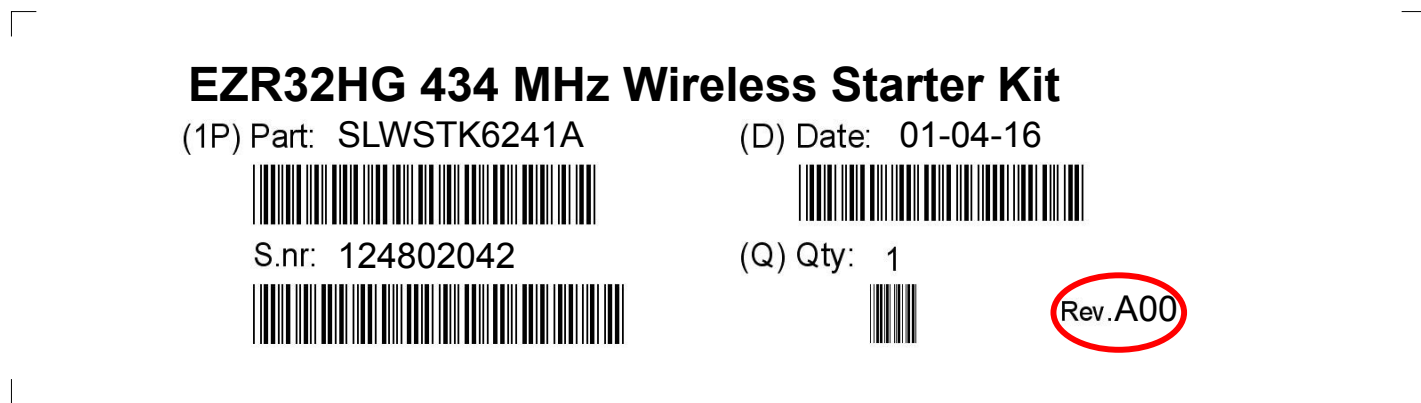

Figure 13.1. Revision info

Table 13.1. Kit Revision History

Kit Revision	Released	Description
A00	01.04.2016	Initial kit release.

13.2 Errata

There are no known errata at present.

14. Document Revision History

Revision 1.00

2016-04-01

Initial document version.

Table of Contents

1. Introduction	1
1.1 Kit Contents	1
1.2 Getting Started	1
2. Kit Hardware Layout	2
3. Kit Block Diagram	3
4. Connectors	4
4.1 Breakout Pads	4
4.2 Expansion Header	5
4.2.1 Expansion header	6
4.3 Debug Connector.	7
4.4 Simplicity Connector.	8
4.5 Debug Adapter	9
5. Power Supply and Reset	10
5.1 Radio Board Power Selection	10
5.2 Board Controller Power.	11
5.3 EZR32 Reset	11
6. Peripherals	12
6.1 Push Buttons and LEDs	12
6.2 Memory LCD-TFT Display.	13
6.3 Si7021 Relative Humidity and Temperature Sensor	14
6.4 USB Micro-B Connector	15
6.5 Virtual COM Port	16
7. Board Controller	17
7.1 Admin Console	17
8. Advanced Energy Monitor	19
8.1 Introduction.	19
8.2 Theory of Operation	19
8.3 AEM Accuracy and Performance	20
8.4 Usage	20
9. On-Board Debugger.	21
9.1 Host Interfaces	21
9.2 Debug Modes	22
9.3 Debugging During Battery Operation	23
10. Device Connectivity	24
10.1 Virtual COM Port	24

10.2 Virtual UART24
11. Kit Manager and Upgrades	25
11.1 Kit Manager Operation25
11.2 Firmware Upgrades25
12. Schematics, Assembly Drawings and BOM	26
13. Kit Revision History and Errata	27
13.1 Revision History.27
13.2 Errata27
14. Document Revision History	28
Table of Contents	29

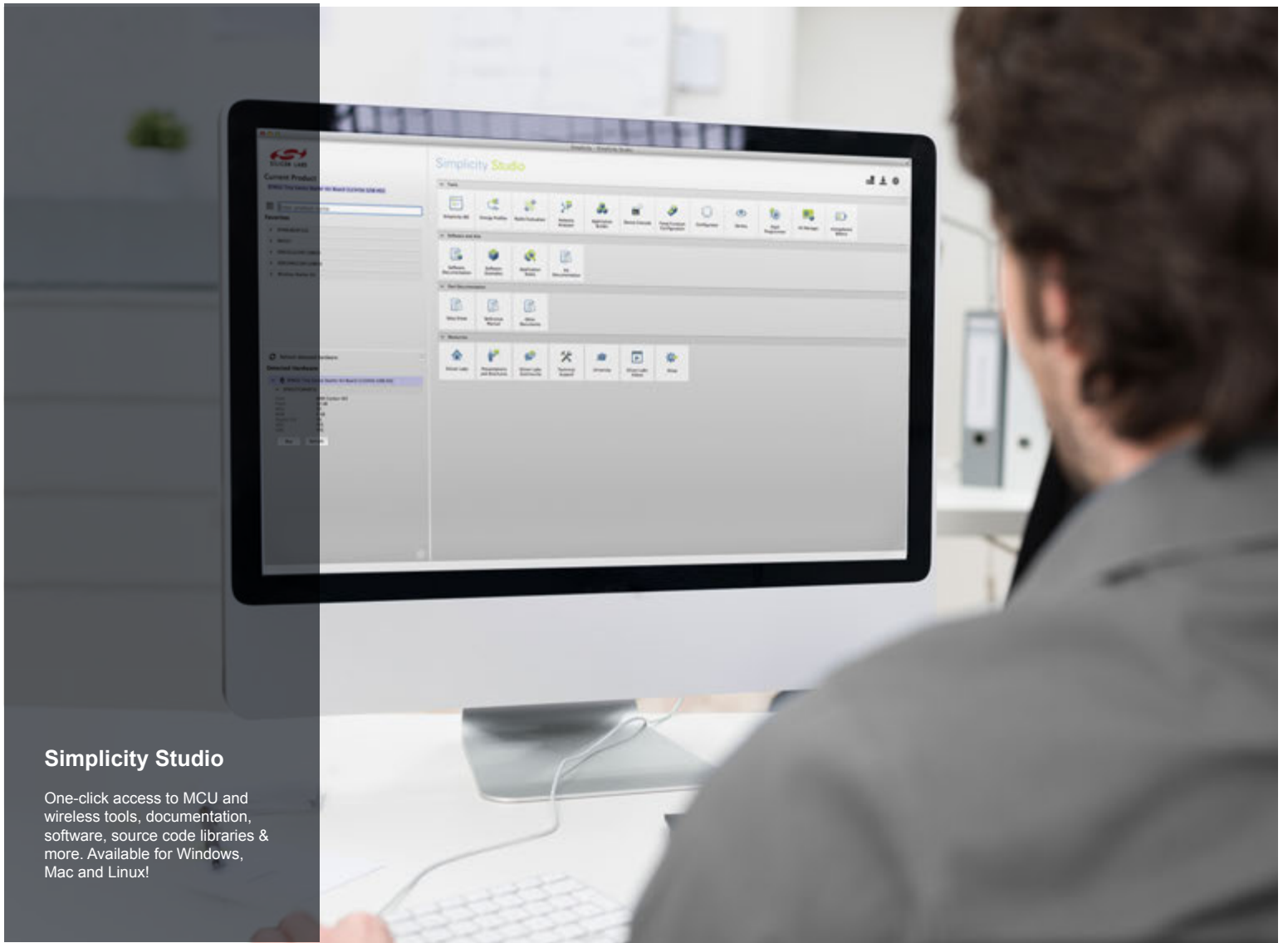

Simplicity Studio

One-click access to MCU and wireless tools, documentation, software, source code libraries & more. Available for Windows, Mac and Linux!



IoT Portfolio
www.silabs.com/iot



SW/HW
www.silabs.com/simplicity



Quality
www.silabs.com/quality



Support and Community
community.silabs.com

Disclaimer

Silicon Laboratories intends to provide customers with the latest, accurate, and in-depth documentation of all peripherals and modules available for system and software implementers using or intending to use the Silicon Laboratories products. Characterization data, available modules and peripherals, memory sizes and memory addresses refer to each specific device, and "Typical" parameters provided can and do vary in different applications. Application examples described herein are for illustrative purposes only. Silicon Laboratories reserves the right to make changes without further notice and limitation to product information, specifications, and descriptions herein, and does not give warranties as to the accuracy or completeness of the included information. Silicon Laboratories shall have no liability for the consequences of use of the information supplied herein. This document does not imply or express copyright licenses granted hereunder to design or fabricate any integrated circuits. The products are not designed or authorized to be used within any Life Support System without the specific written consent of Silicon Laboratories. A "Life Support System" is any product or system intended to support or sustain life and/or health, which, if it fails, can be reasonably expected to result in significant personal injury or death. Silicon Laboratories products are not designed or authorized for military applications. Silicon Laboratories products shall under no circumstances be used in weapons of mass destruction including (but not limited to) nuclear, biological or chemical weapons, or missiles capable of delivering such weapons.

Trademark Information

Silicon Laboratories Inc.®, Silicon Laboratories®, Silicon Labs®, SiLabs® and the Silicon Labs logo®, Bluegiga®, Bluegiga Logo®, Clockbuilder®, CMEMS®, DSPLL®, EFM®, EFM32®, EFR®, Ember®, Energy Micro, Energy Micro logo and combinations thereof, "the world's most energy friendly microcontrollers", Ember®, EZLink®, EZRadio®, EZRadioPRO®, Gecko®, ISOModem®, Precision32®, ProSLIC®, Simplicity Studio®, SIPHY®, Telegesis, the Telegesis Logo®, USBXpress® and others are trademarks or registered trademarks of Silicon Laboratories Inc. ARM, CORTEX, Cortex-M3 and THUMB are trademarks or registered trademarks of ARM Holdings. Keil is a registered trademark of ARM Limited. All other products or brand names mentioned herein are trademarks of their respective holders.



Silicon Laboratories Inc.
 400 West Cesar Chavez
 Austin, TX 78701
 USA

<http://www.silabs.com>