

ROHM Nano Energy™ Switching Regulator Solutions

BD70522GUL Ultra-Low Iq Buck Converter Evaluation Board

Introduction

This application note will provide the steps necessary to operate and evaluate ROHM's synchronous buck DC/DC converter using the BD70522GUL evaluation board. Component selection and operating procedures are included.

Description

The BD70522GUL converter is a power supply solution designed for battery powered devices. 180nA quiescent current and ULP (Ultra Low Power) mode enable excellent light load efficiency at 10µA load, extending battery life, while output currents up to 500mA are supported. Users can select from among 9 preset output voltages via the VSEL pin. And when the input voltage gets close to the output voltage, the IC enters 100% ON mode that stops switching operation.

Applications

- Smoke detectors
- Thermostats
- Portable devices
- Wearables
- Low-Iq sets without standby switcher
- Energy harvesting

Features

- Nano Energy™
- Up to 90% efficiency at 10µA output current
- 9 selectable output voltages (1.2V, 1.5V, 1.8V, 2.0V, 2.5V, 2.8V, 3.0V, 3.2V, 3.3V)
- Power Good output
- 100% ON Mode for low input voltage
- Discharge function on VOUT.

Key Specifications

Input voltage range	2.5 to 5.5V
Output voltage range	1.2 to 3.3V
Maximum output current	500mA
Operation quiescent current	180nA
Standby current	50nA
VCSP50L1C package	

Evaluation Board Operating Limits and Absolute Maximum Ratings

Parameter	Symbol	Limit			Unit	Conditions
		MIN	TYP	MAX		
Supply Voltage	VSYS	2.5	-	5.5	V	
Output Current	I _{OUT}	-	-	0.5	A	
PG Sink Current	I _{PG}	-	-	10	mA	

Evaluation Board

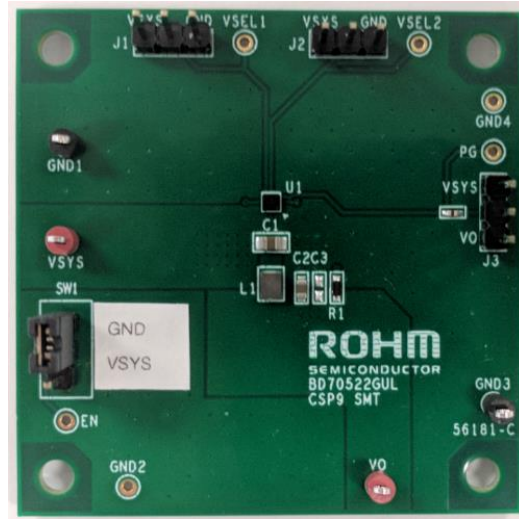

Figure 1: BD70522GUL Evaluation Board

Board Schematic

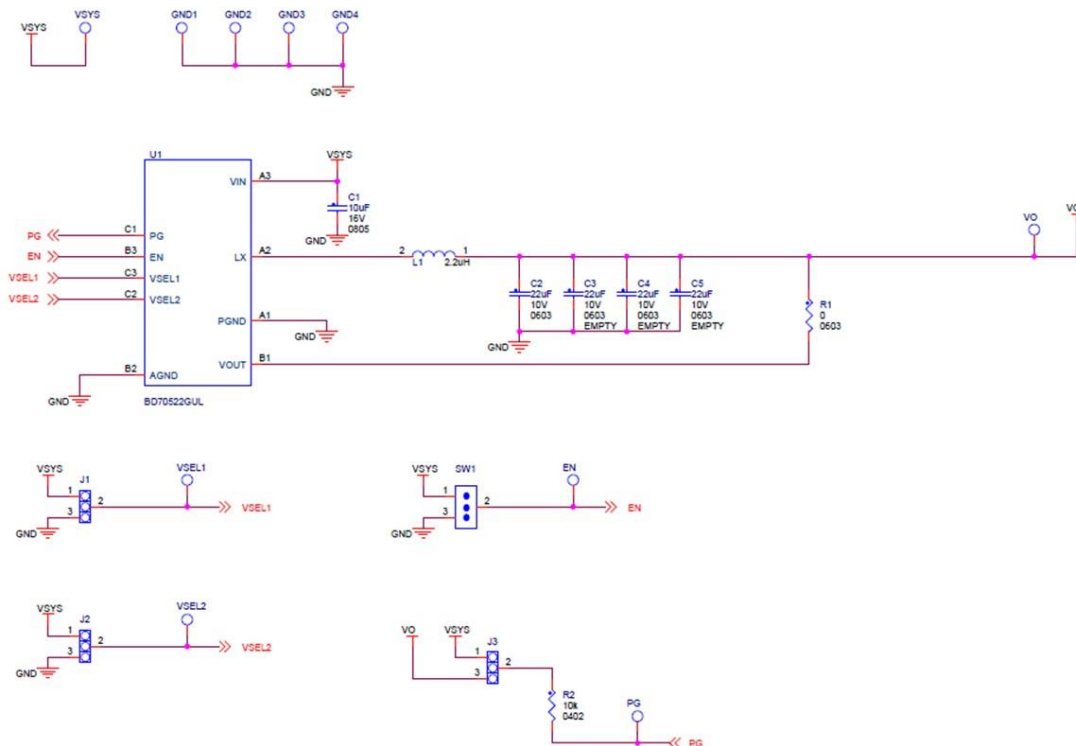

Figure 2: BD70522GUL Evaluation Board Schematic

Output Voltage Settings

Below is a table of output voltages selectable using the VSEL1 and VSEL2 pins.

V _{SET}	VSEL1	VSEL2
1.2V	GND	OPEN
1.5V	OPEN	GND
1.8V	GND	GND
2.0V	V _{IN}	GND
2.5V	OPEN	V _{IN}
2.8V	V _{IN}	OPEN
3.0V	OPEN	OPEN
3.2V	GND	V _{IN}
3.3V	V _{IN}	V _{IN}

Table 1: Output Voltage Settings

EN Pin	BD70522GUL Condition
High	Enable
GND	Shutdown

Table 2: EN Pin Settings

Evaluation Board BOM

Below is a table showing the Bill of Materials. Part numbers and suppliers are included.

Reference	Part Number	Manufacturer	Description [Unit: inch]	Qty.
U1	BD70522GUL	ROHM		1
C2	JMK107BBJ226MA	TAIYO YUDEN	22uF, 10V, X5R, 0603	1
C3,C4,C5	JMK107BBJ226MA	TAIYO YUDEN	22uF, 10V, X5R, 0603	3
C1	EMK212ABJ106KD-T	TAIYO YUDEN	10uF, 16V, X5R, 0805	1
L1	MAMK2520H2R2M	TAIYO YUDEN	2.2uH, 2.8A, 2520	1
R1	PMR03EZPJ000	ROHM	0, 0603	1
R2	MCR01MRTF1002	ROHM	10k, 0402	1
J1,J2,J3, SW1	61300311121	Würth Electronics	2.54mm, 3pin, straight	4
SW1	N/A			
VSYS, VO	5000	Keystone Electronics	Red Test Point	2
GND1,GND3	5001	Keystone Electronics	Black Test Point	2
EN,GND2,GND4,PG,VSEL1,VSEL2	N/A			

Table 3: Bill of Materials

Board Operating Procedure

1. Set the output voltage using the jumper settings at J1 and J2. (refer to Table 1)
2. Disable the IC by setting the SW1 jumper to the upper position (EN → GND).
3. Connect the power supply's GND terminal to the GND1 or GND3 test point on the evaluation board.
4. Connect the power supply's V_{CC} terminal to the V_{sys} test point on the evaluation board. This will provide V_{IN} to the IC. Please note that V_{IN} should be in the range of 2.5V to 5.5V.
5. Connect the electronic load to GND1 or GND3 and VO. Connect the voltmeter to GND1 or GND3 and VO.
6. Turn on the power supply and enable the IC by setting the jumper at SW1 to the lower position (EN → VSYS). The output voltage can be measured at test point VO. Now turn on the load. The load can be increased up to 0.5A (max.).

Reference Application Data

The following are graphs of the hot plugging test, efficiency, switching frequency, load response, output voltage, ripple, startup and shutdown.

Typical Performance Curves (Unless otherwise indicated, $L=2.2\mu\text{H}$, $C_{out}=22\mu\text{F}\times 1$, $T_a=25^\circ\text{C}$)

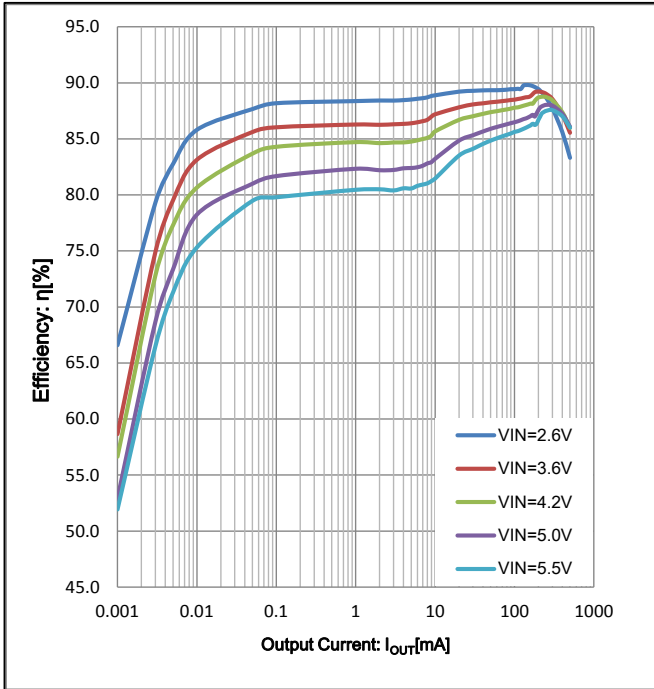

Figure 3. Efficiency vs Output Current ($V_{OUT}=1.2\text{V}$)

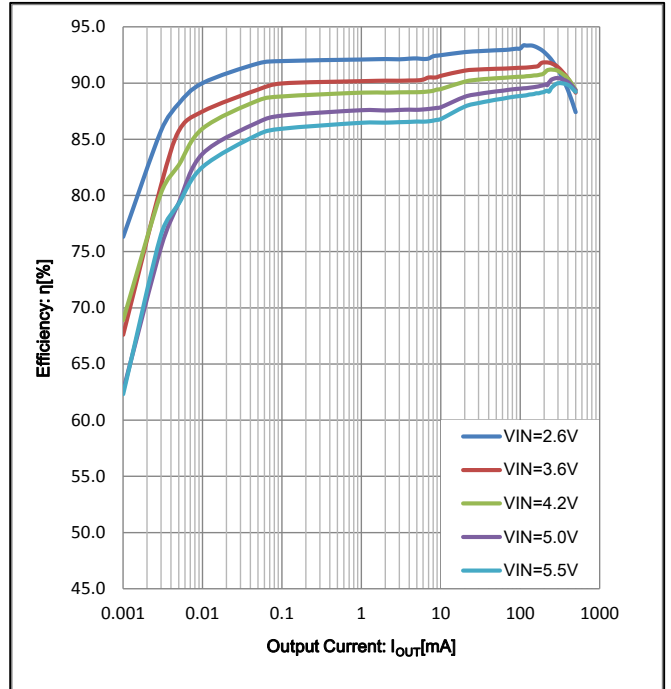

Figure 4. Efficiency vs Output Current ($V_{OUT}=1.8\text{V}$)

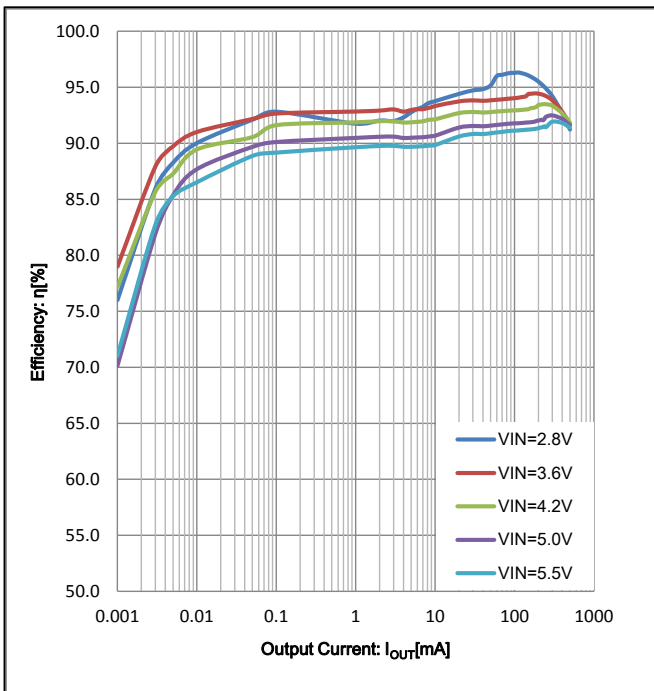

Figure 5. Efficiency vs Output Current ($V_{OUT}=2.5\text{V}$)

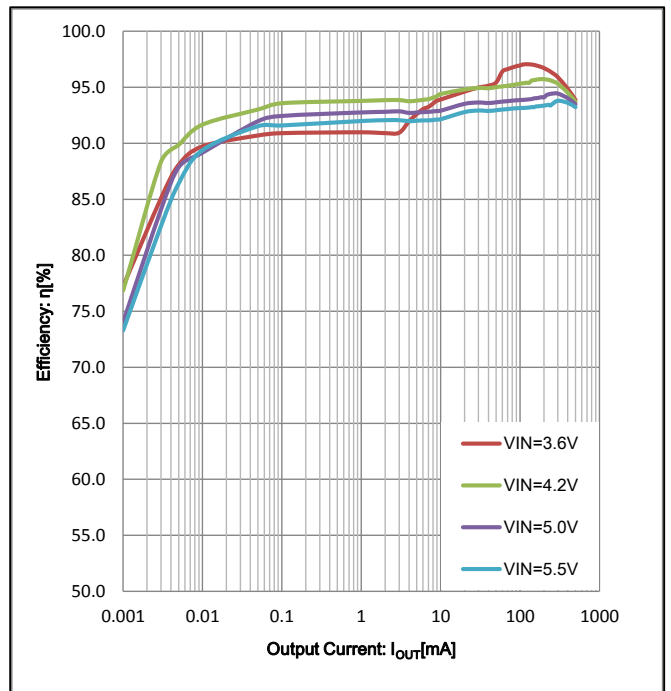

Figure 6. Efficiency vs Output Current ($V_{OUT}=3.3\text{V}$)

Typical Performance Curves (continued)

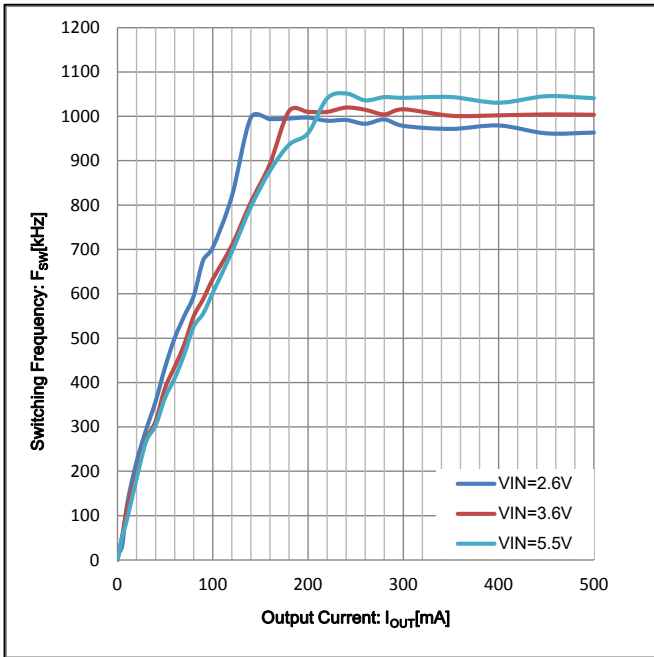

Figure 7. Switching Frequency vs Output Current (V_{OUT}=1.2V)

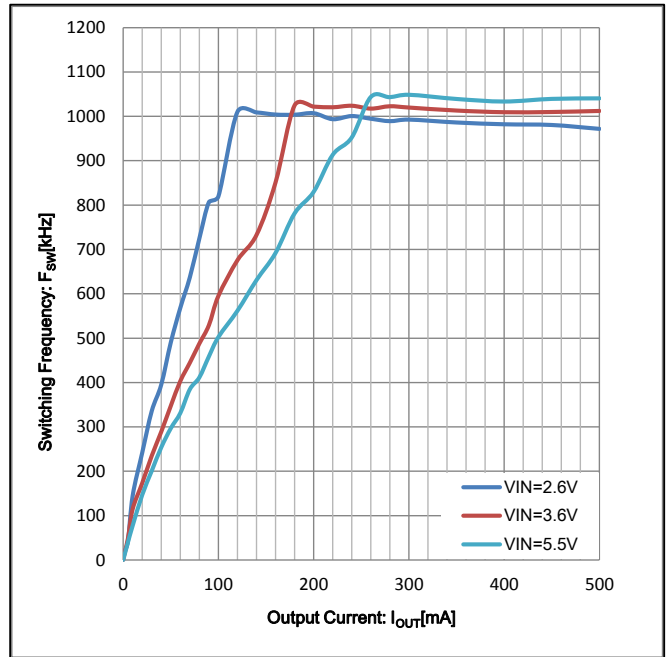

Figure 8. Switching Frequency vs Output Current (V_{OUT}=1.8V)

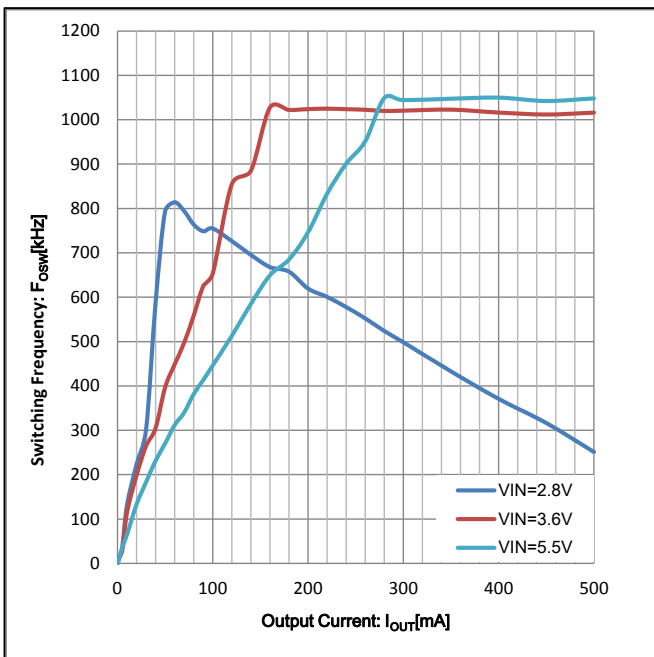

Figure 9. Switching Frequency vs Output Current (V_{OUT}=2.5V)

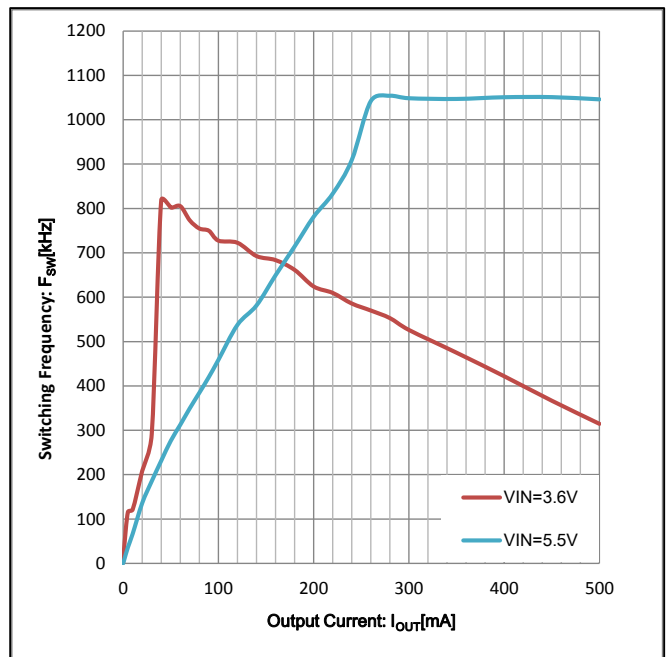

Figure 10. Switching Frequency vs Output Current (V_{OUT}=3.3V)

Typical Performance Curves (continued)

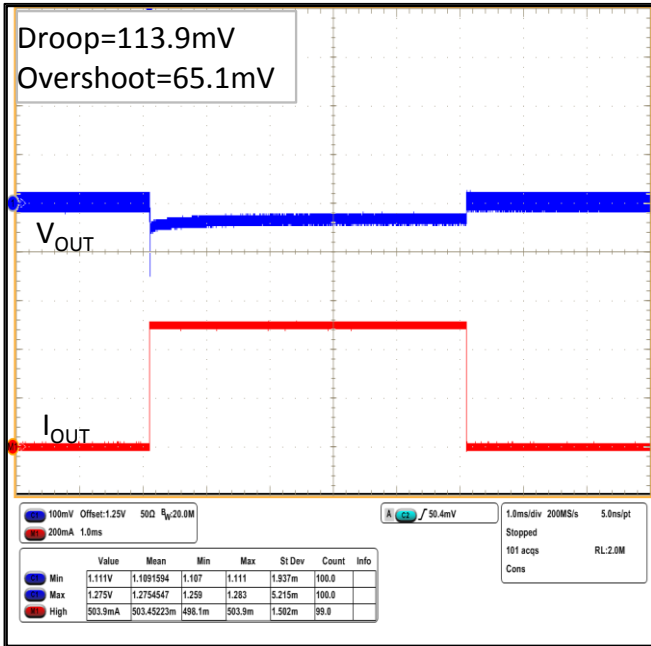

Figure 11. Load Transient Response
($V_{IN}=3.6V$, $V_{OUT}=1.2V$, $I_{OUT}=1\mu A \Leftrightarrow 500mA$, $t_r=t_f=1\mu s$)

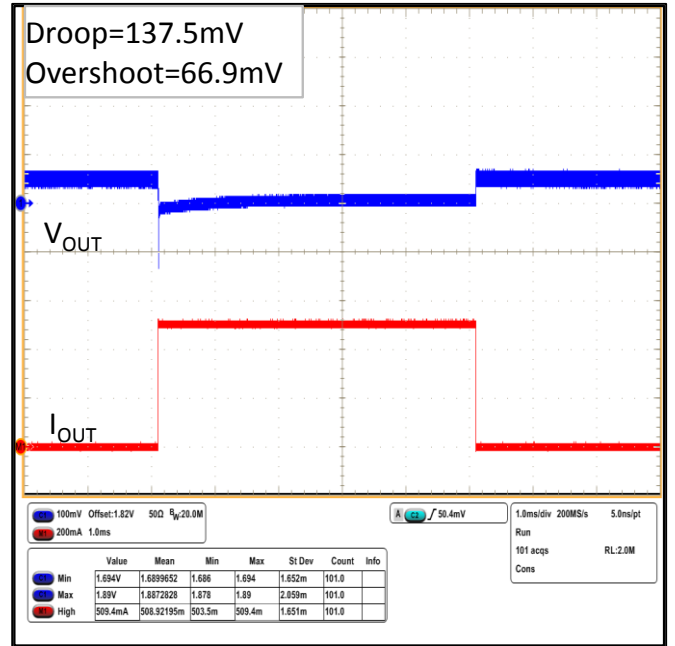

Figure 12. Load Transient Response
($V_{IN}=3.6V$, $V_{OUT}=1.8V$, $I_{OUT}=1\mu A \Leftrightarrow 500mA$, $t_r=t_f=1\mu s$)

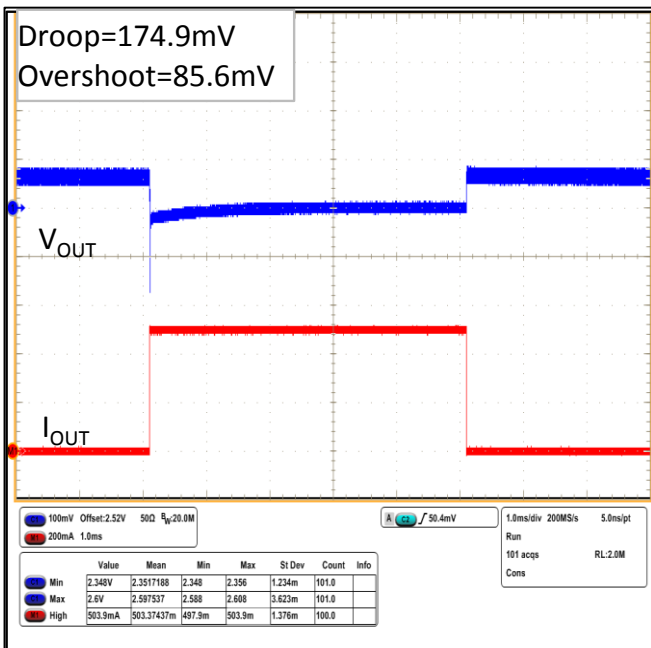

Figure 13. Load Transient Response
($V_{IN}=3.6V$, $V_{OUT}=2.5V$, $I_{OUT}=1\mu A \Leftrightarrow 500mA$, $t_r=t_f=1\mu s$)

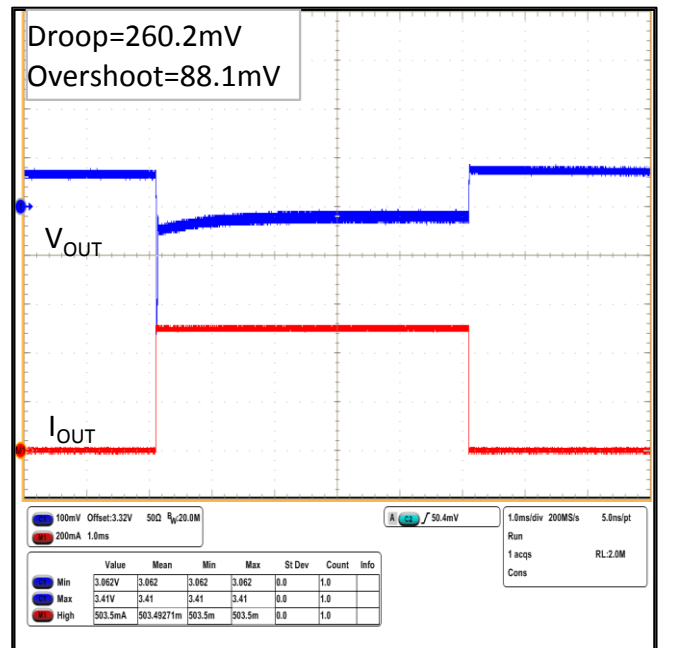

Figure 14. Load Transient Response
($V_{IN}=3.6V$, $V_{OUT}=3.3V$, $I_{OUT}=1\mu A \Leftrightarrow 500mA$, $t_r=t_f=1\mu s$)

Typical Performance Curves (continued)

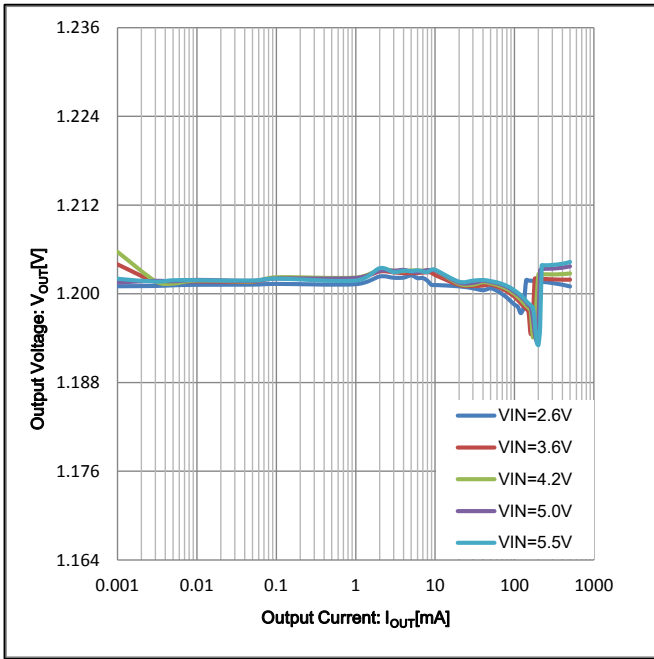

Figure 15. Output Voltage vs Output Current (Load Regulation, $V_{OUT}=1.2V$)

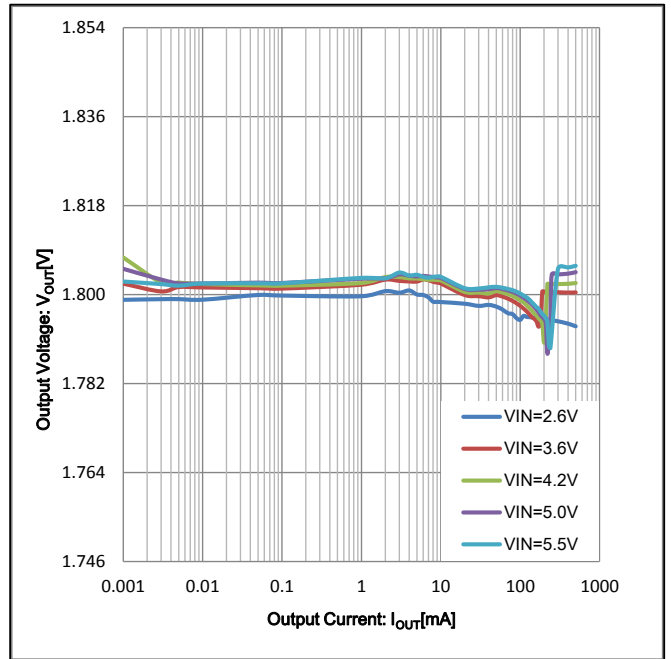

Figure 16. Output Voltage vs Output Current (Load Regulation, $V_{OUT}=1.8V$)

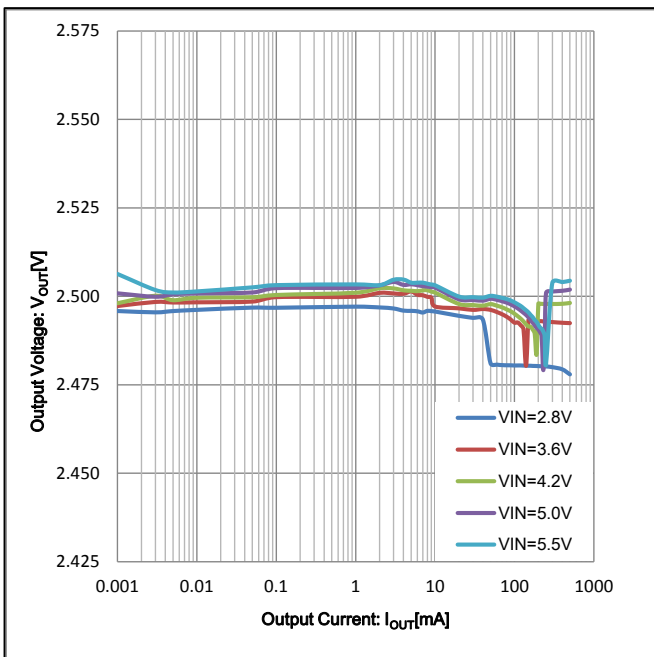

Figure 17. Output Voltage vs Output Current (Load Regulation, $V_{OUT}=2.5V$)

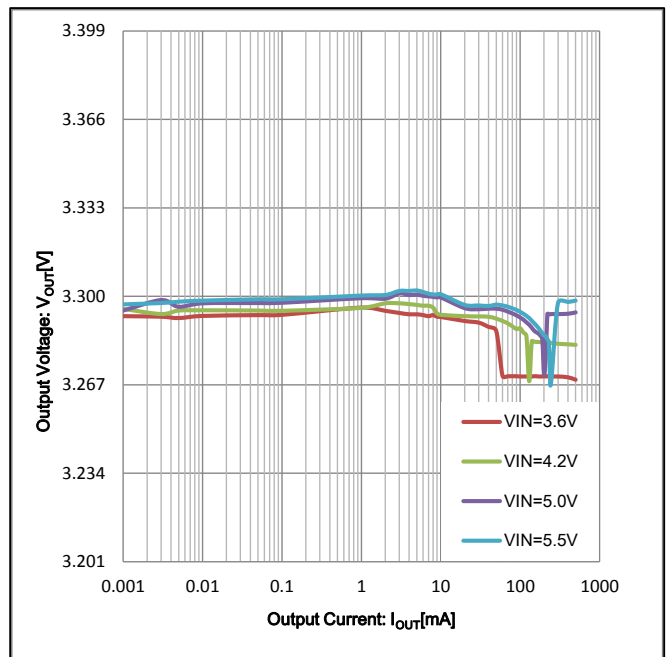

Figure 18. Output Voltage vs Output Current (Load Regulation, $V_{OUT}=3.3V$)

Typical Performance Curves (continued)

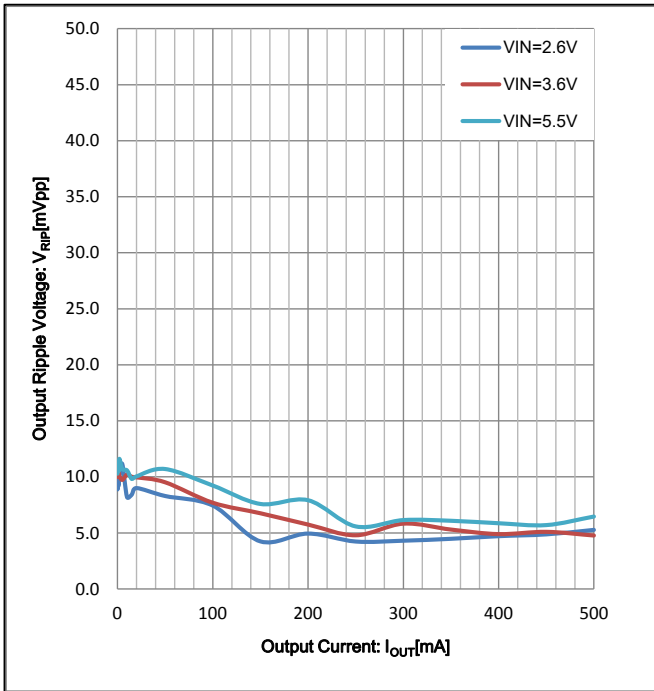

Figure 19. Output Ripple Voltage vs Output Current (Peak to Peak Output Ripple Voltage, $V_{OUT}=1.2V$)

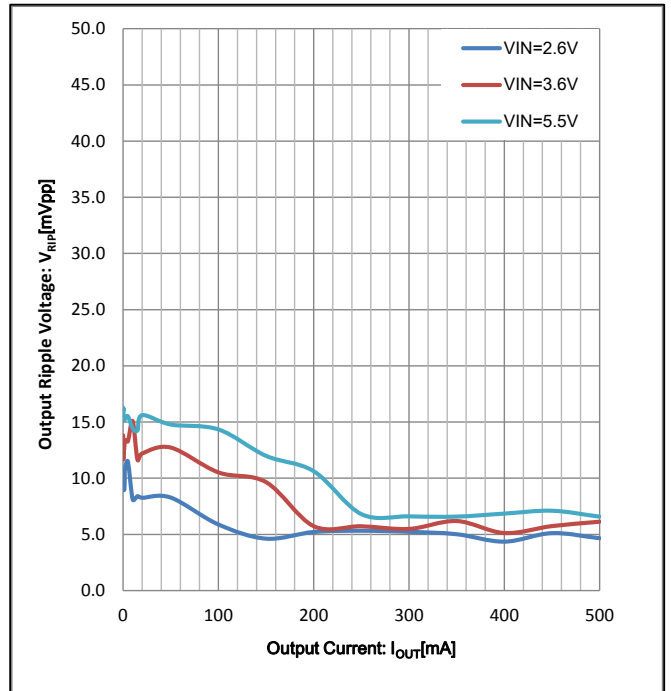

Figure 20. Output Ripple Voltage vs Output Current (Peak to Peak Output Ripple Voltage, $V_{OUT}=1.8V$)

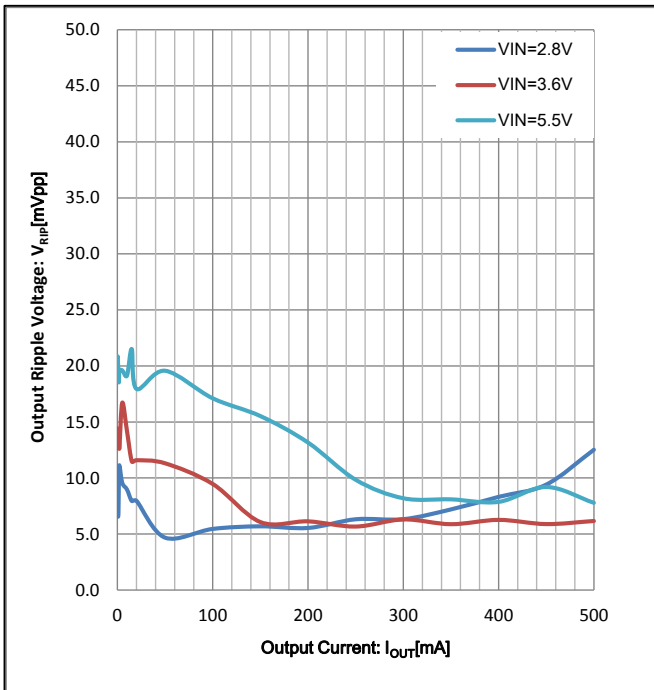

Figure 21. Output Ripple Voltage vs Output Current (Peak to Peak Output Ripple Voltage, $V_{OUT}=2.5V$)

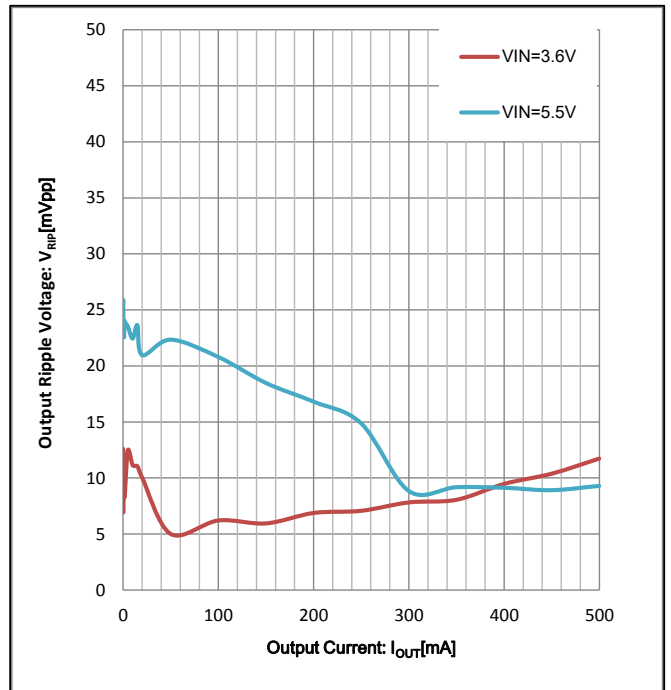

Figure 22. Output Ripple Voltage vs Output Current (Peak to Peak Output Ripple Voltage, $V_{OUT}=3.3V$)

Typical Performance Curves (continued)

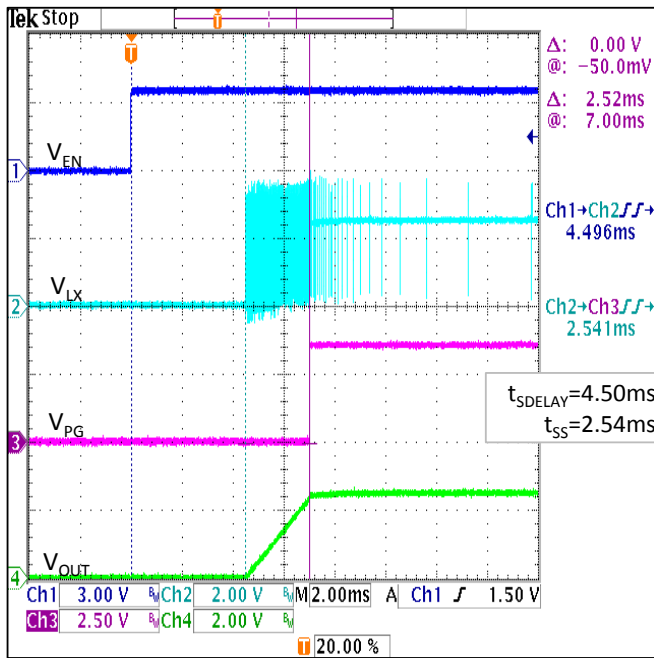

Figure 23. Startup
 ($V_{IN}=3.6V$, $V_{OUT}=2.5V$, $I_{OUT}=0mA$, $EN=0 \rightarrow V_{IN}$)

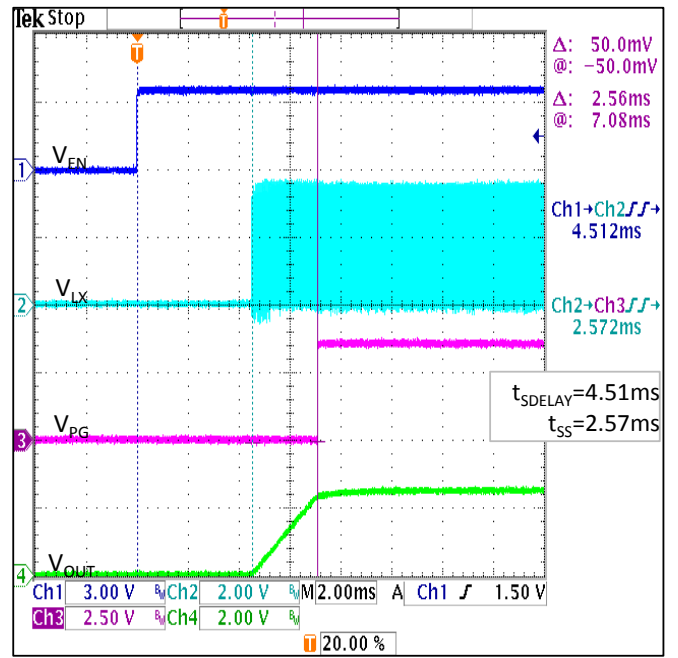

Figure 24. Startup
 ($V_{IN}=3.6V$, $V_{OUT}=2.5V$, $I_{OUT}=500mA$, $EN=0 \rightarrow V_{IN}$)

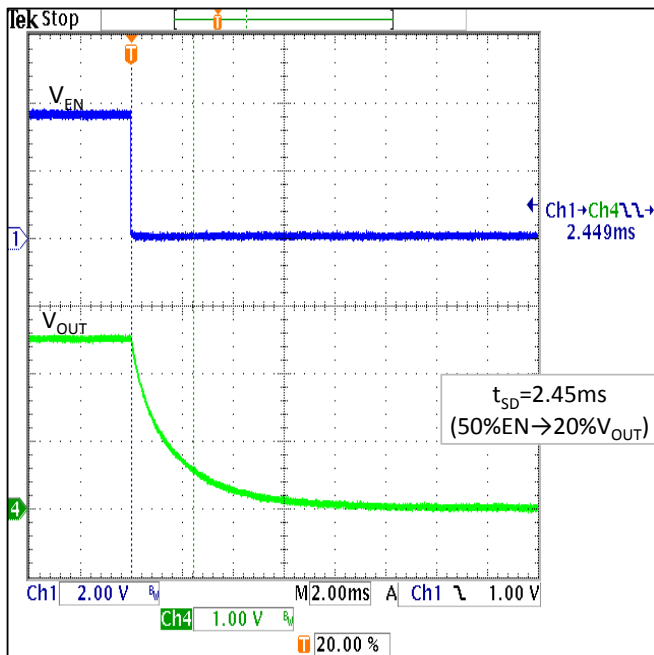

Figure 25. Shutdown
 ($V_{IN}=3.6V$, $V_{OUT}=2.5V$, $I_{OUT}=0mA$, $EN=V_{IN} \rightarrow 0$)

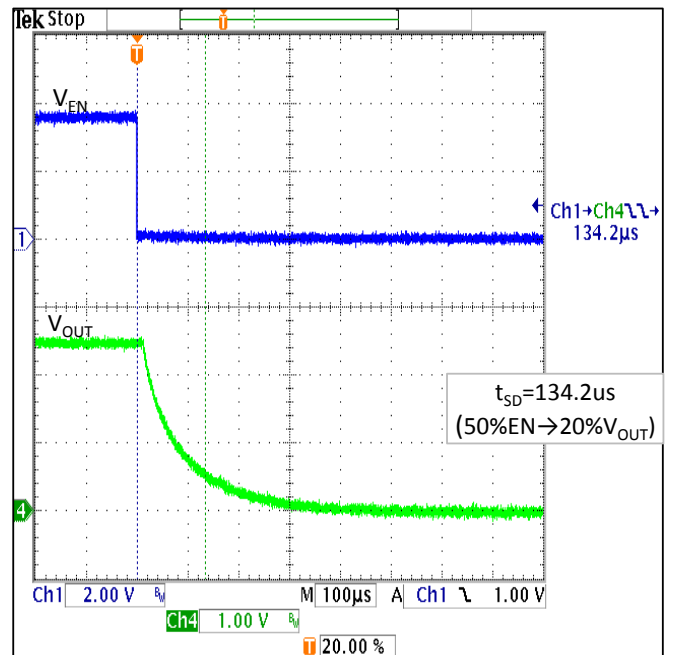

Figure 26. Shutdown
 ($V_{IN}=3.6V$, $V_{OUT}=2.5V$, $I_{OUT}=500mA$, $EN=V_{IN} \rightarrow 0$)

Notes

- 1) The information contained herein is subject to change without notice.
- 2) Before you use our Products, please contact our sales representative and verify the latest specifications :
- 3) Although ROHM is continuously working to improve product reliability and quality, semiconductors can break down and malfunction due to various factors.
Therefore, in order to prevent personal injury or fire arising from failure, please take safety measures such as complying with the derating characteristics, implementing redundant and fire prevention designs, and utilizing backups and fail-safe procedures. ROHM shall have no responsibility for any damages arising out of the use of our Products beyond the rating specified by ROHM.
- 4) Examples of application circuits, circuit constants and any other information contained herein are provided only to illustrate the standard usage and operations of the Products. The peripheral conditions must be taken into account when designing circuits for mass production.
- 5) The technical information specified herein is intended only to show the typical functions of and examples of application circuits for the Products. ROHM does not grant you, explicitly or implicitly, any license to use or exercise intellectual property or other rights held by ROHM or any other parties. ROHM shall have no responsibility whatsoever for any dispute arising out of the use of such technical information.
- 6) The Products specified in this document are not designed to be radiation tolerant.
- 7) For use of our Products in applications requiring a high degree of reliability (as exemplified below), please contact and consult with a ROHM representative : transportation equipment (i.e. cars, ships, trains), primary communication equipment, traffic lights, fire/crime prevention, safety equipment, medical systems, servers, solar cells, and power transmission systems.
- 8) Do not use our Products in applications requiring extremely high reliability, such as aerospace equipment, nuclear power control systems, and submarine repeaters.
- 9) ROHM shall have no responsibility for any damages or injury arising from non-compliance with the recommended usage conditions and specifications contained herein.
- 10) ROHM has used reasonable care to ensure the accuracy of the information contained in this document. However, ROHM does not warrants that such information is error-free, and ROHM shall have no responsibility for any damages arising from any inaccuracy or misprint of such information.
- 11) Please use the Products in accordance with any applicable environmental laws and regulations, such as the RoHS Directive. For more details, including RoHS compatibility, please contact a ROHM sales office. ROHM shall have no responsibility for any damages or losses resulting non-compliance with any applicable laws or regulations.
- 12) When providing our Products and technologies contained in this document to other countries, you must abide by the procedures and provisions stipulated in all applicable export laws and regulations, including without limitation the US Export Administration Regulations and the Foreign Exchange and Foreign Trade Act.
- 13) This document, in part or in whole, may not be reprinted or reproduced without prior consent of ROHM.



Thank you for your accessing to ROHM product informations.
More detail product informations and catalogs are available, please contact us.

ROHM Customer Support System

<http://www.rohm.com/contact/>