



**PART No. 2CLD84836**

for more information visit  
[www.hammfg.com](http://www.hammfg.com)

Data subject to change without notice

Isometric drawing Not to Scale

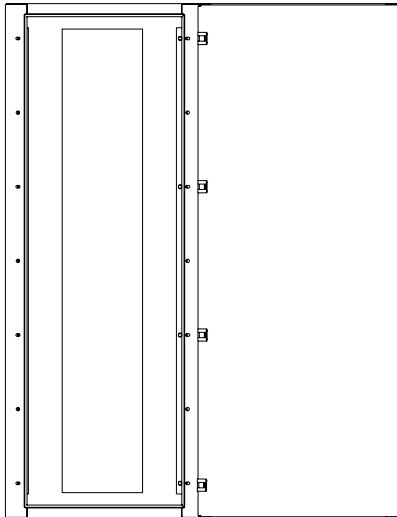

TOP VIEW

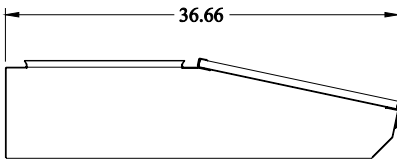

LEFT SIDE VIEW

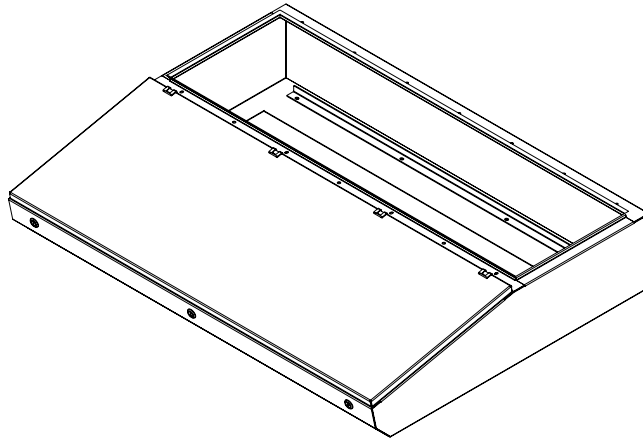

ISOMETRIC VIEW

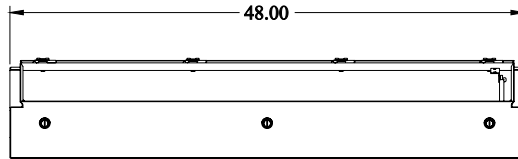

FRONT VIEW

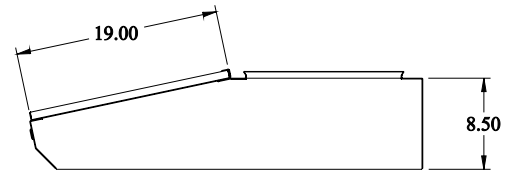

RIGHT SIDE VIEW