



PART No. C3R303012SC

for more information visit
www.hammfg.com

Data subject to change without notice

Isometric drawing Not to Scale

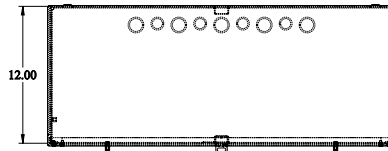

12.00

TOP VIEW

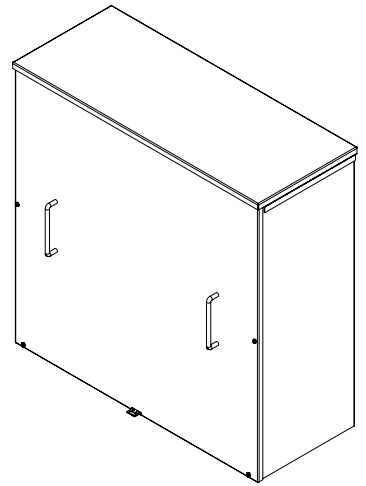

ISOMETRIC VIEW

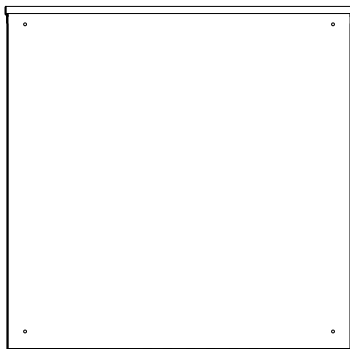

BACK VIEW

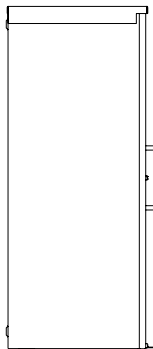

LEFT SIDE VIEW

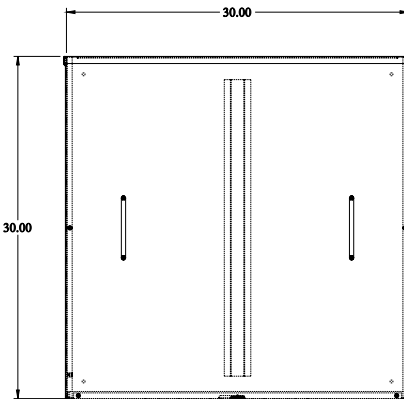

30.00

30.00

FRONT VIEW

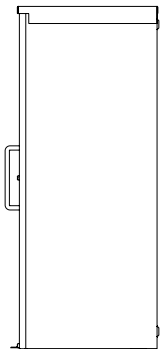

RIGHT SIDE VIEW

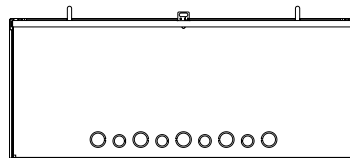

BOTTOM VIEW