

MINNIE-WWW

~70° wide beam

TECHNICAL SPECIFICATIONS:

Dimensions	Ø 32.4 mm
Height	14.8 mm
Fastening	glue
Colour	metal
Box size	480 x 280 x 300 mm
Box weight	3.9 kg
Quantity in Box	1080 pcs
ROHS compliant	yes ⓘ



MATERIAL SPECIFICATIONS:

Component	Type	Material	Colour	Coating
MINNIE-WWW	Reflector	PC	metal	lacquer

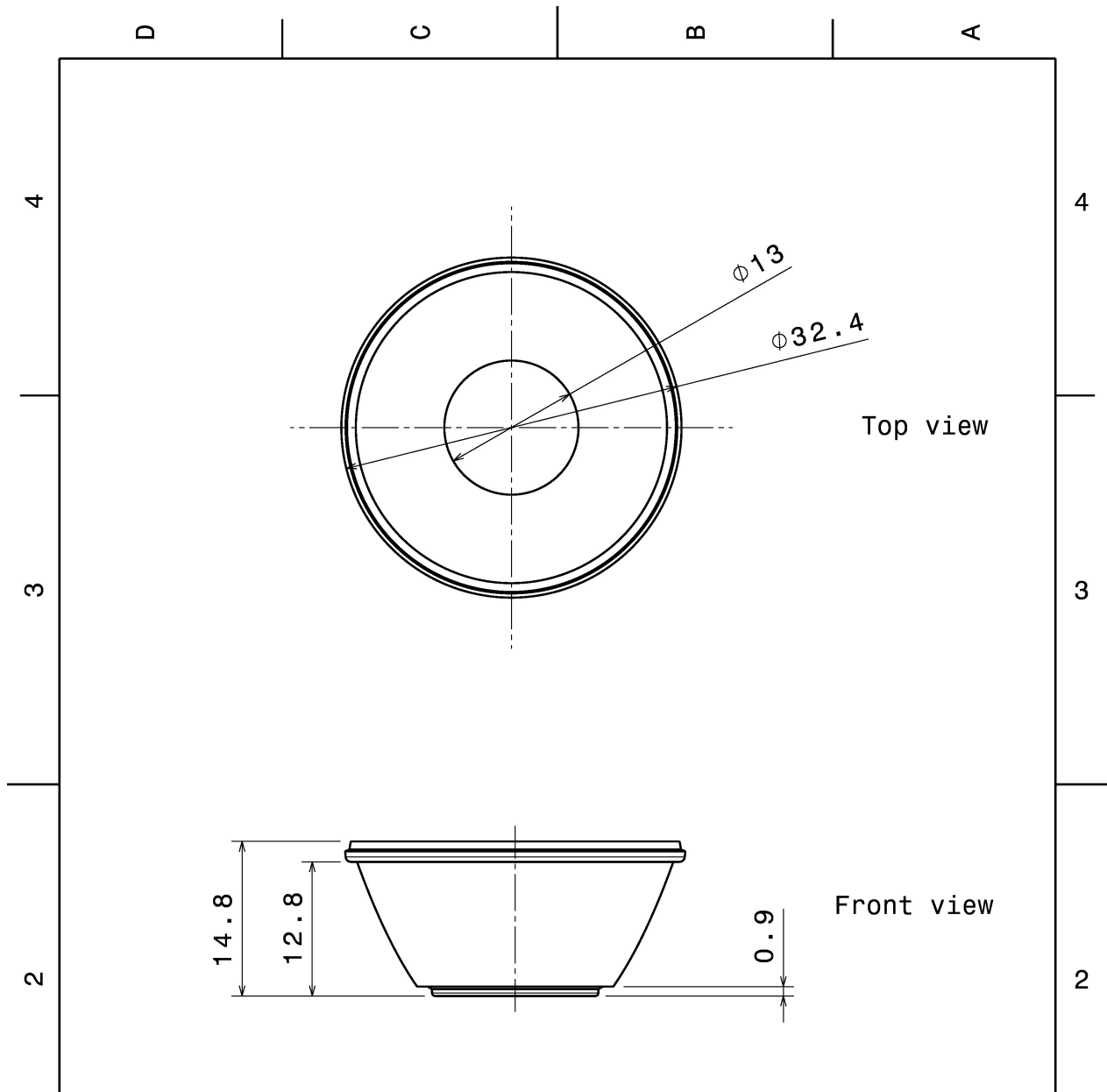

Version without holder,
correct mounting height from the PCB 1,0 mm

Tolerances if not otherwise shown
According to DIN ISO 2768-1
Linear measures:
Up to 30mm class F, otherwise class M.
According to DIN ISO 2768-2
Form and position: class K

LEDiL Ledil Oy
Salorankatu 10
FIN 24240 SALO
Finland

THIRD ANGLE PROJECTION:

DRAWING TITLE
Datasheet Minnie-www

This drawing is the property of LEDiL Oy. It may not be reproduced, copied or communicated without a written agreement with LEDiL Oy."

SIZE	PART NUMBER
A4	-

SCALE	2:1	WEIGHT	(g)	SHEET	1/1
-------	-----	--------	-----	-------	-----

D A

PHOTOMETRIC DATA (MEASURED):

CREE 

LED MHD-E/G
FWHM 72.0°
Efficiency 90 %
Peak intensity 0.720 cd/lm
Required components:

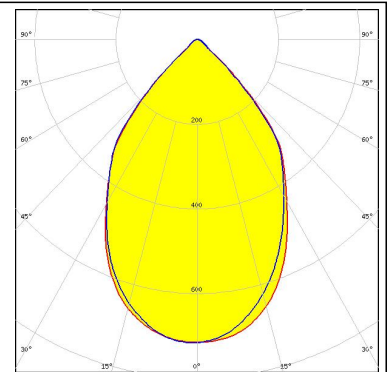
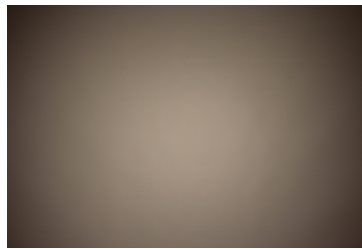

CREE 

LED MT-G
FWHM 74.0°
Efficiency 90 %
Peak intensity cd/lm
Required components:

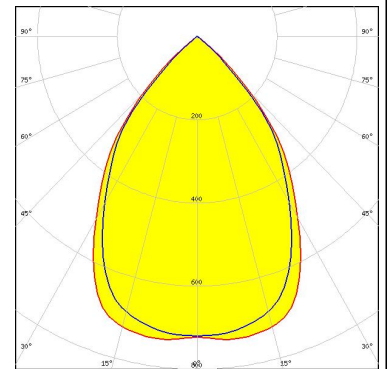
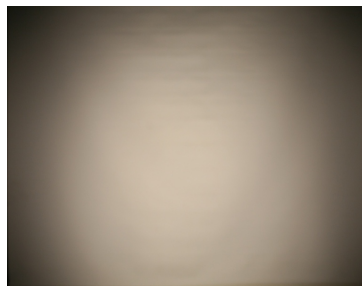

CREE 

LED XHP70
FWHM 71.0°
Efficiency 90 %
Peak intensity 0.730 cd/lm
Required components:

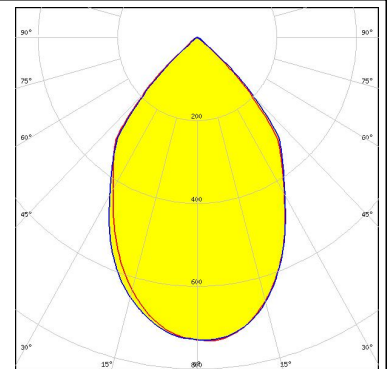
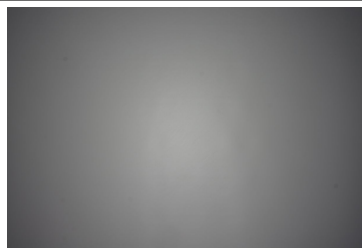

 **LUMILEDS**

LED LUXEON M/MX
FWHM 63.0°
Efficiency 92 %
Peak intensity 0.869 cd/lm
Required components:

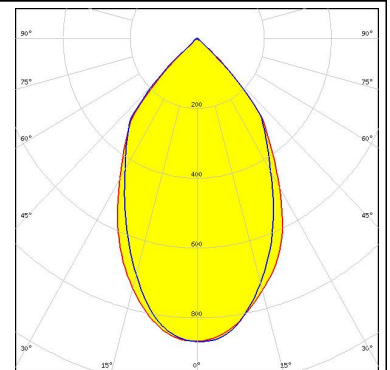
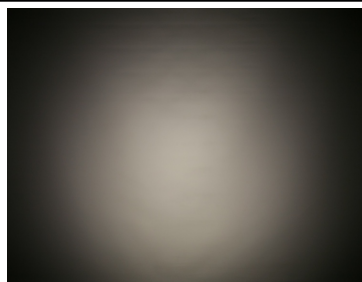

PHOTOMETRIC DATA (MEASURED):



LED LUXEON MZ
FWHM 46.0°
Efficiency 89 %
Peak intensity 1.200 cd/lm
Required components:

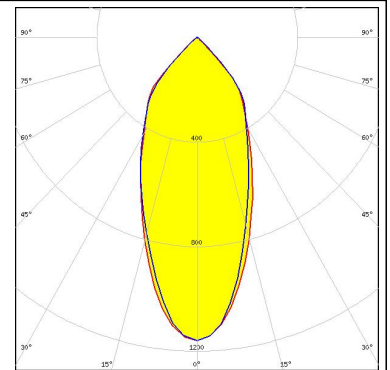

LED NSMx286M
FWHM 52.0°
Efficiency 90 %
Peak intensity 1.050 cd/lm
Required components:

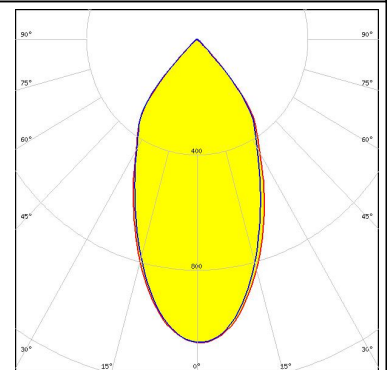
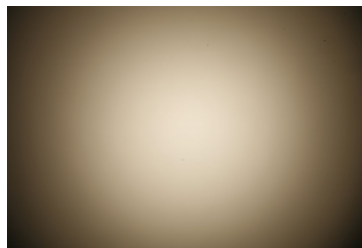

PHOTOMETRIC DATA (SIMULATED):



LED LUXEON 5258
FWHM 54.0°
Efficiency 92 %
Peak intensity 1.100 cd/lm
Required components:



LED OSCONIQ P 7070
FWHM 61.0°
Efficiency 92 %
Peak intensity 1.000 cd/lm
Required components:

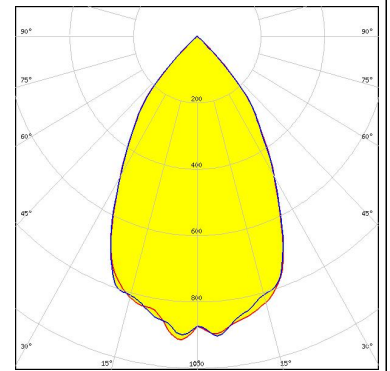

GENERAL INFORMATION:

NOTE: The typical beam angle will be changed by different color, chip size and chip position tolerance. The typical total beam angle is the full angle measured where the luminous intensity is half of the peak value.

MATERIALS:

As part of our continuous research and improvement processes, and to ensure the best possible quality and availability of our products, LEDiL reserves the right to change material grades without notice.

PRODUCT DATA USER AGREEMENT AND DISCLAIMER:

The measured data in the provided downloadable LEDiL Product Datasheets and Mechanical 2D-Drawings is rounded and provided as reference for planning. LEDiL Oy's optical specifications have been verified by conducting performance testing of the products in accordance with the company's quality system. The reported data are averaged results of multiple measurements with typical variation. LEDiL Oy reserves the right to without prior notification make changes and improvements to its products.

LEDiL Oy assumes neither warranty, nor guarantee nor any other liability of any kind for the contents and correctness of the provided data. The provided data has been generated with highest diligence but the provided data may in reality not represent the complete possible variation range of all intrinsic parameters. Therefore, in certain cases a deviation from the provided data could occur.

LEDiL Oy reserves the right to undertake technical changes of its products without further notification which could lead to changes in the provided data. LEDiL Oy assumes no liability of any kind for the possible deviation from any provided data or any other damage resulting from the usage of the provided data.

The user agrees to this disclaimer and user agreement with the download or usage of the provided files.

LEDiL Oy

Joensuunkatu 13
FI-24240 SALO
Finland

LEDiL Inc.

228 West Page Street
Suite D
Sycamore IL 60178
USA

Local sales and technical support

[www.ledil.com/
where_to_buy](http://www.ledil.com/where_to_buy)

Shipping locations

Salo, Finland
Hong Kong, China

Distribution Partners

[www.ledil.com/
where_to_buy](http://www.ledil.com/where_to_buy)