

General Description

The MAX77826 evaluation kit (EV kit) is a fully assembled and tested PCB that evaluates the MAX77826 power-management IC. The MAX77826 includes 1 BUCK regulator, 1 BUCK-BOOST regulator, 15 LDOs (3 NMOS LDOs and 12 PMOS LDOs) and an I²C Interface. The I²C interface supports output-voltage setting, turning on/off of all regulators and reading interrupt/status registers.

The MINIQUSB interface board can be used to enable PC communication through the USB interface board. Windows® 2000-, Windows XP®, Windows Vista®, and Windows 7-compatible software along with an extender board allows an IBM-compatible PC to use the USB port to emulate an I²C 2-wire interface. This menu-driven program offers a graphical user interface (GUI) with control buttons.

Features

- Provides a Reference PCB Layout for Mobile Applications by Using Small Footprint External Components
- Jumpers for Chip Enable (CE)
- Jumpers for GPIO Enable for BUCK, BUCK BOOST, and LDO12
- Jumpers for Switching LDOs Input Supplies
- Built-In 1.8V LDO for VIO Supply

Windows, Windows Vista, and Windows XP are registered trademarks and registered service marks of Microsoft Corporation.

Ordering Information appears at end of data sheet.

Quick Start

Required Equipment

- Variable power supply capable of supplying up to 5.5V
- Multimeters
- PC with a spare USB port
- MINIQUSB+ command module (USB cable included)
- MAX77826 EV kit

Procedure

The MAX77826 EV kit is a fully assembled and tested surface-mount board. Follow the steps below to verify board operation. Caution: Do not turn on the power supply until all connections are completed.

- 1) Visit www.maximintegrated.com/evkitsoftware to download the latest version of the EV kit software, xx.ZIP. Save the EV kit software to a temporary folder and uncompress the ZIP file.
- 2) Install the EV kit software on your computer by running the INSTALL.EXE program inside the temporary folder. The program files are copied and icons are created in the Windows Start | Programs menu.
- 3) Carefully connect the MINIQUSB+ command module with the MAX77826 EV kit by aligning the 16-pin connector J1 and 8-pin receptacle J2 of the MAX77826 EV kit with the 16-pin receptacle J3 and 8-pin header J4 of the MINIQUSB+ interface board, respectively.
- 4) Connect the USB cable from the PC to the MINIQUSB+ command module.
- 5) Preset the power supply to 3.7V. Turn off the power supply.
- 6) Connect the positive lead of the 3.7V power supply to the VBATT pad. Connect the negative lead of the 3.7V power supply to the GND pad.
- 7) Turn on the power supply.
- 8) Move Jumper JU6 from 2-3 to 1-2 (chip enable).
- 9) Start the MAX8904 program by opening its icon in the Start | Programs menu. The EV kit software main window appears, as shown in Figure 1.
- 10) Wait until seeing **Command Module Connected, Device Connected** as shown in Figure 1.
- 11) Click Turn on All Regulator button.
- 12) Verify that all regulators output default voltage.

Detailed Description of Software

The MAX77826 EV kit uses the MINIQUSB+ command module for an I2C interface to control the MAX77826 IC. The EV kit software displays six tabs to control and monitor status of the MAX77826 IC, INTERRUPT, STATUS, OPMD, CFG(1), CFG(2), and FREQ/UVLO/DEVICE_ID.

INTERRUPT Tab

The INTERRUPT tab sheet allows user to monitor interrupts (refer to MAX77826 data sheet for details) and mask each interrupt if needed.

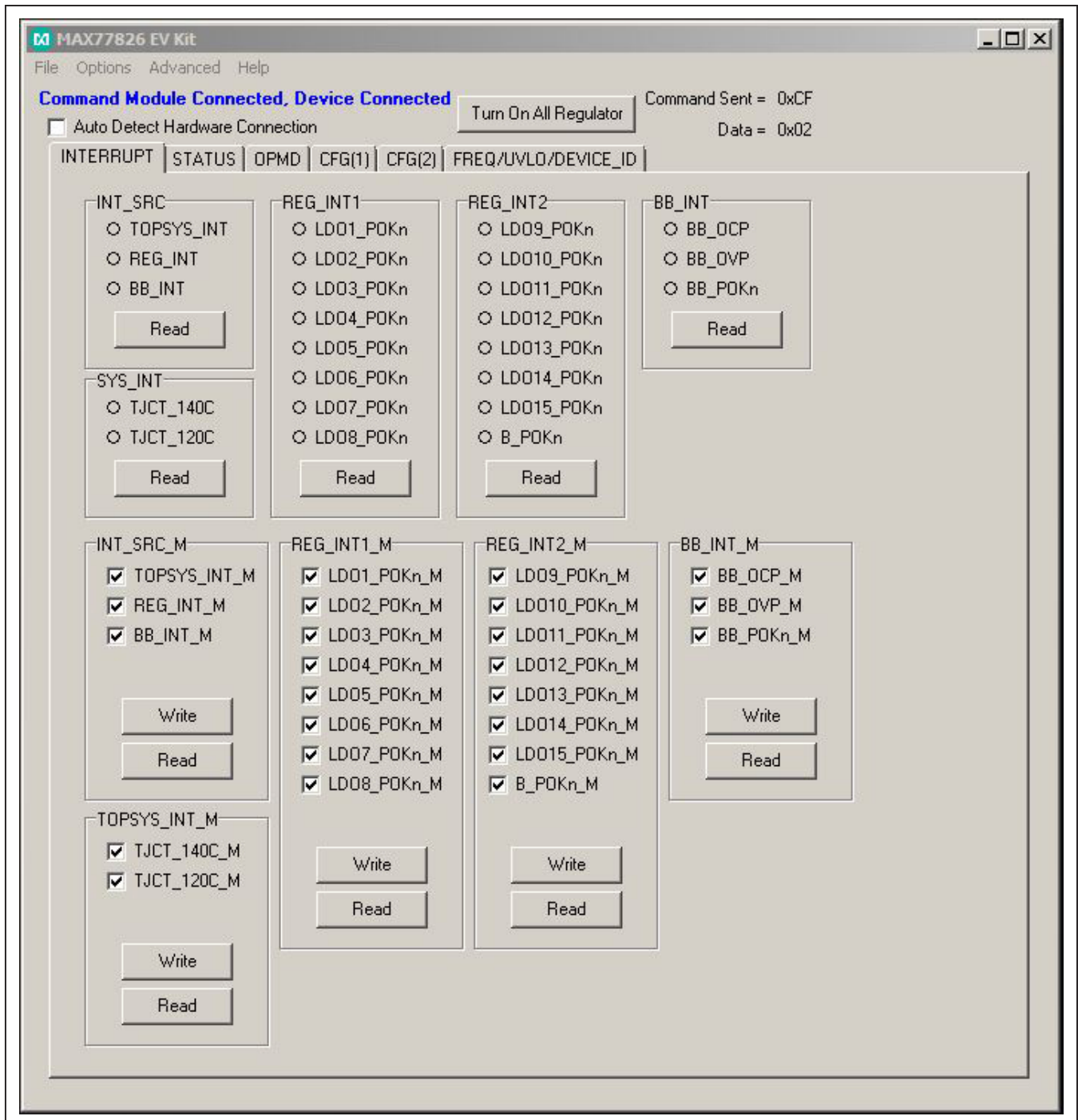

Figure 1. MAX77826 EV Kit Software (INTERRUPT Tab)

STATUS Tab

The STATUS tab sheet allows user to monitor status LDO, BUCK, and BUCK BOOST.

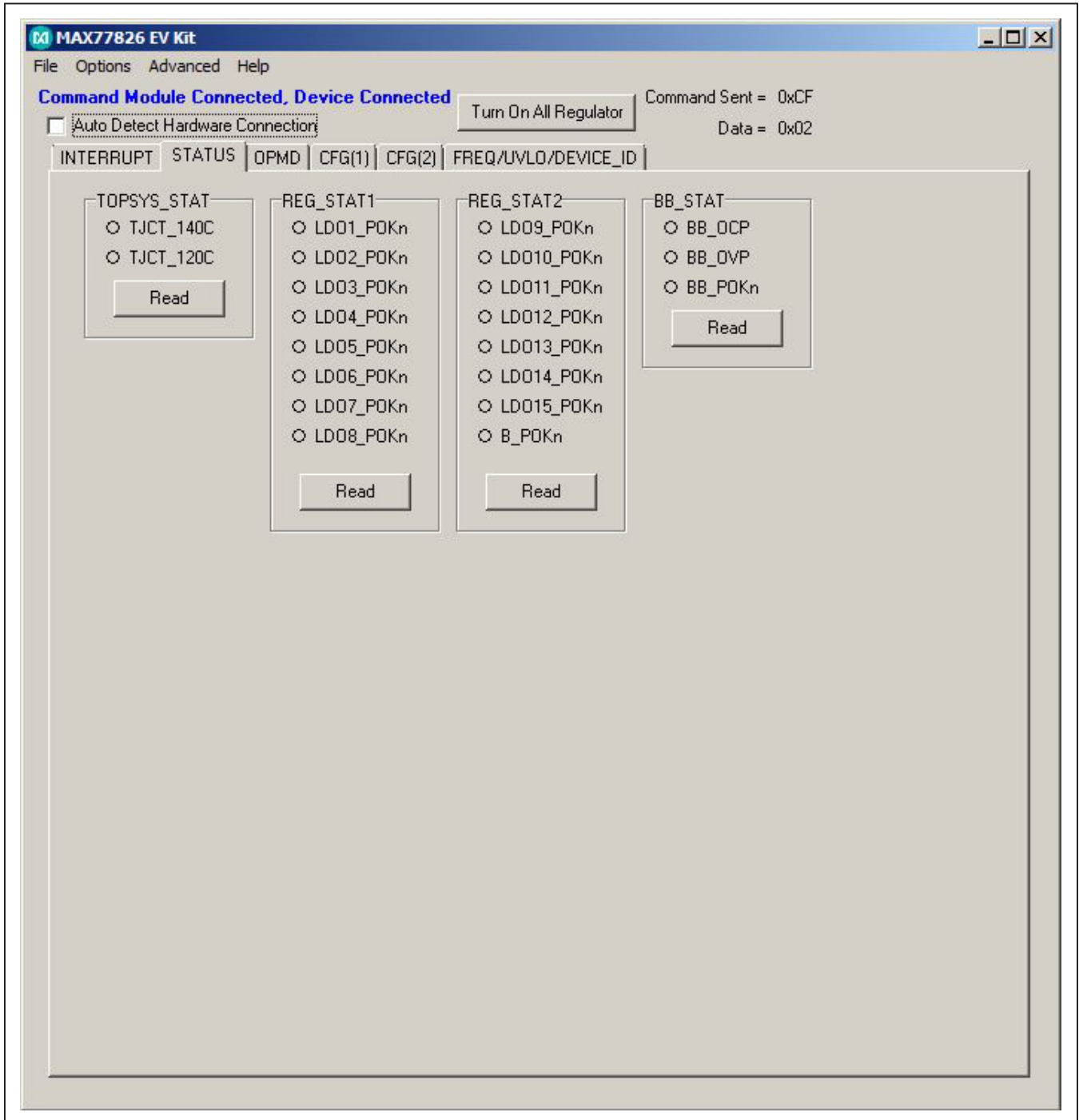

Figure 2. MAX77826 EV Kit Software (STATUS Tab)

OPMD Tab

The OPMD tab sheet allows user to turn on/off LDO, BUCK, and BUCK BOOST. Also, it allows LDO and BUCK to be placed into LPM (low power mode).

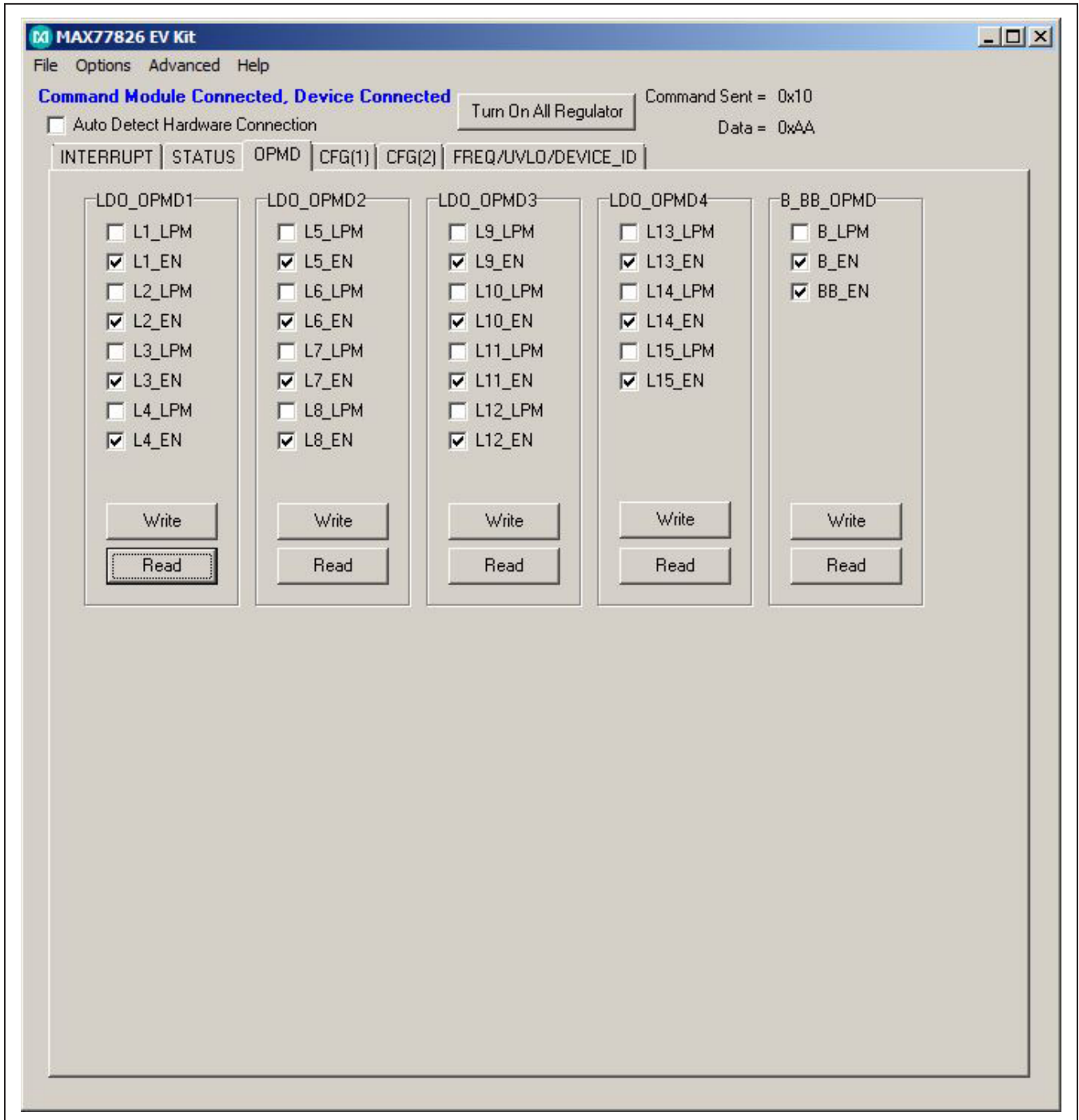

Figure 3. MAX77826 EV Kit Software (OPMD Tab)

CFG(1) Tab

The CFG(1) tab sheet allows user to change LDO output voltage (LDO1–LDO12) and turn on/off active discharge function.

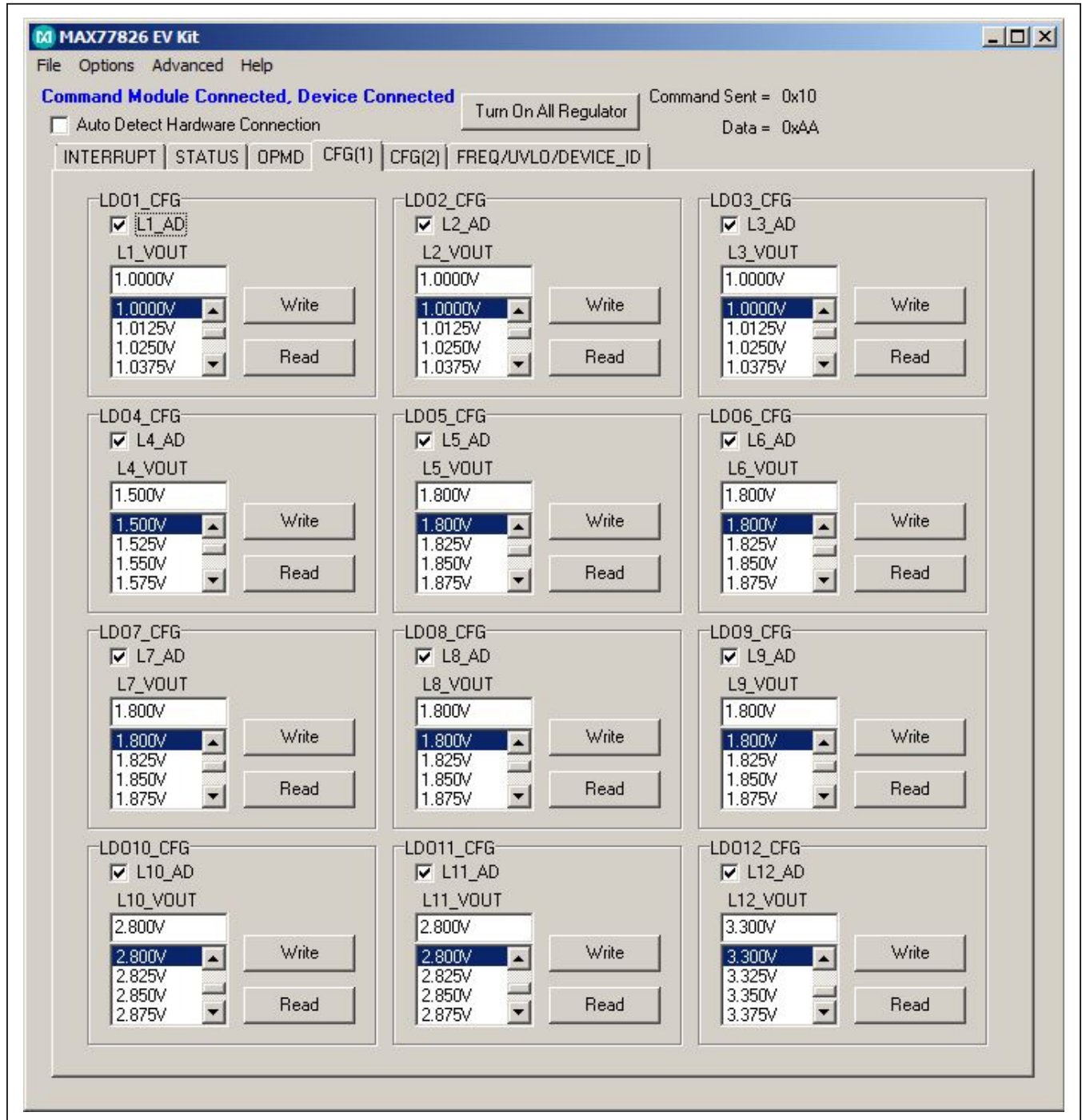

Figure 4. MAX77826 EV Kit Software (CFG(1) Tab)

CFG(2) Tab

The CFG(2) tab sheet allows user to change output voltage of LDO (LDO13–LDO15), BUCK, and BUCK BOOST. It also provides turn on/off active discharge function of each regulators and selects BUCK and BUCK BOOST operation modes.

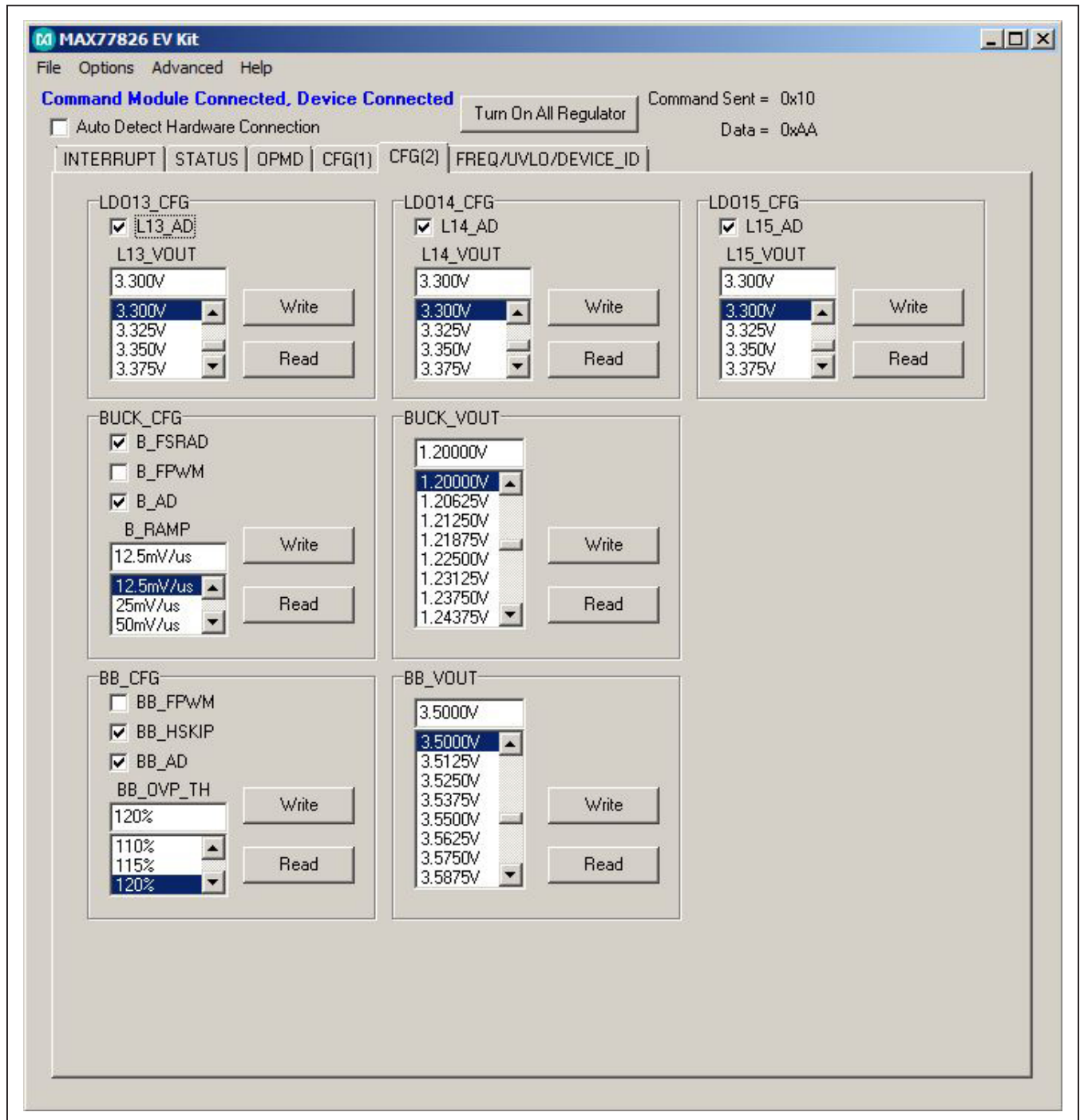

Figure 5. MAX77826 EV Kit Software (CFG(2) Tab)

FREQ/UVLO/DEVICE_ID Tab

The FREQ/UVLO/DEVICE_ID tab sheet allows user to change BUCK switching frequency and soft-start slew rate. Also, it provides interface to change UVLO_F threshold and read DEVICE_ID.

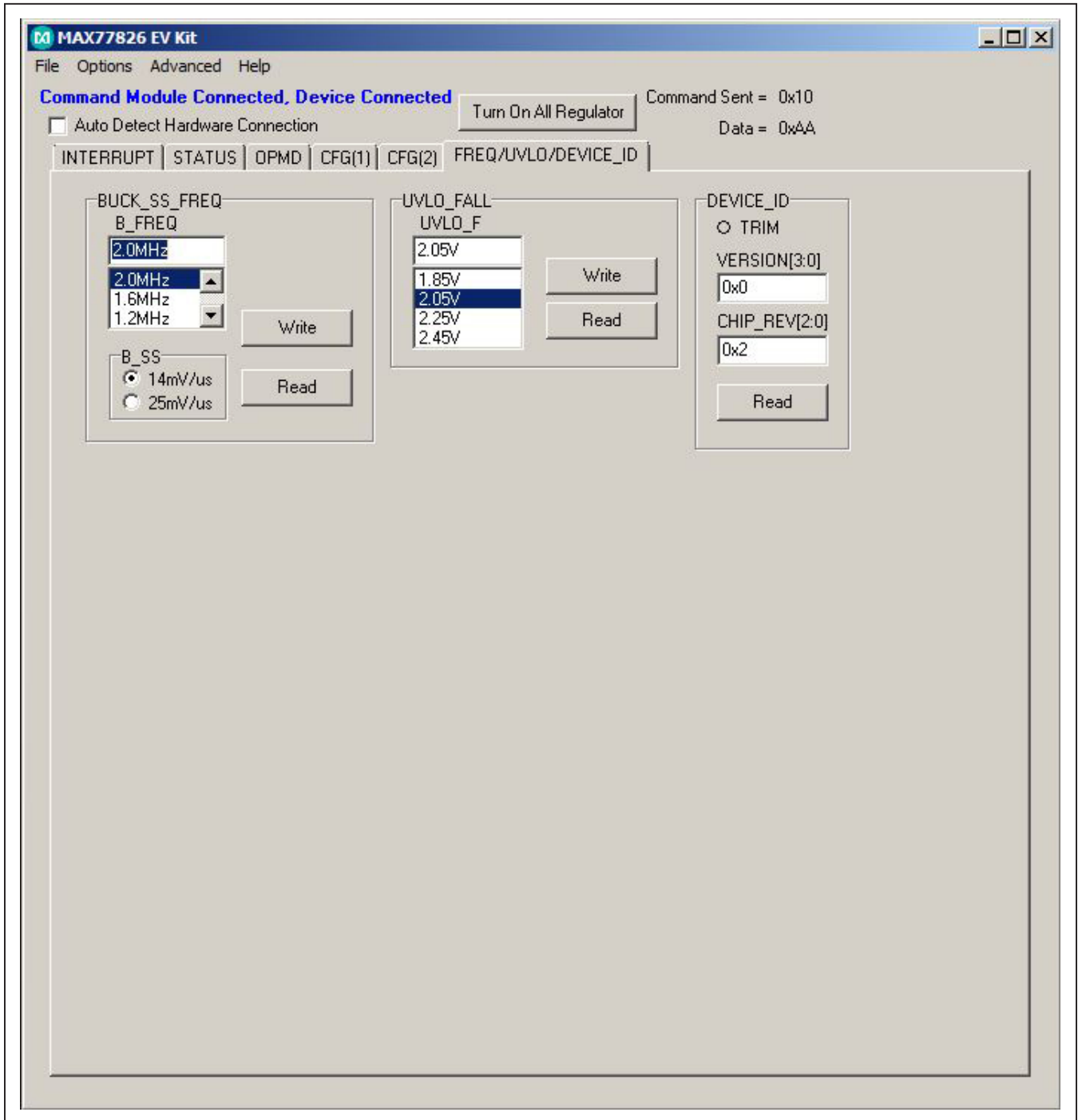

Figure 6. MAX77826 EV Kit Software (FREQ/UVLO/DEVICE_ID)

Detailed Description of Software

BUCK Regulator

The MAX77826 includes a 3A current-mode BUCK regulator. In normal operation, BUCK consumes only 22 μ A quiescent current. In low power mode, the quiescent current decreases to 8 μ A with reduced load capability.

The summary of features is:

- 3A (max) output current rating
- 2.6V to 5.5V input voltage range
- Output voltage range from 0.50V to 1.80V in 6.25mV steps
- $\pm 1\%$ (typ) output voltage DC accuracy
- 2MHz (typ) switching frequency
- Automatic SKIP/PWM or forced PWM modes
 - 90% peak efficiency
- Programmable slew rate for increasing output voltage settings

BUCK BOOST Regulator

The MAX77826 BUCK BOOST regulator utilizes a four-switch H-bridge configuration to realize BUCK, BUCK-BOOST, and BOOST operating modes. In this way, this topology maintains output voltage regulation when the input voltage is greater than, equal to, or less than the output voltage. The MAX77826 BUCK-BOOST is ideal in Li-ion battery powered applications, providing 2.6V to 4.1875V output voltage and up to 2A output current across the input voltage range. High switching frequency and a unique control algorithm allow the smallest solution size, low output noise, and highest efficiency across a wide input voltage and output current range.

LDO Regulator

The MAX77826 provides 15 low-dropout linear regulators, including 3 NMOS LDOs, 6 PMOSLV LDOs, and 6 PMOSLS LDOs. Each of these regulators draws 27 μ A / 18 μ A (NMOS / PMOS) of quiescent current in normal operating mode and < 5 μ A in Low Power mode. PMOSLV LDOs allow input voltages as low as 1.7V for optimized system efficiency.

All regulators can be operated in Low Power mode which supports up to 5mA of maximum load current.

The summary of features is:

- 3 NMOS LDOs (VOUT Range: 0.6V to 2.1875V with 12.5mV Step)
 - 1 x 150mA
 - 1 x 450mA
 - 1 x 600mA
- 6 PMOSLV LDOs (VOUT Range: 0.8V to 3.975V with 25mV Step)
 - 3 x 150mA
 - 3 x 300mA
- 6 PMOSLS LDOs (VOUT Range: 0.8V to 3.975V with 25mV Step)
 - 3 x 150mA
 - 3 x 300mA
- $\pm 1.5\%$ Typical Output Voltage DC Accuracy
- 70dB PSRR at 1kHz

Component List

PART	QTY	DESCRIPTION
C1, C3	2	10 μ F \pm 10%, 6.3V, X5R ceramic capacitor (0603), Taiyo Yuden, JMK107ABJ106MA-L
C12, C16, C17, C18, C20, C21, C23, C24, C25	9	4.7 μ F \pm 10%, 6.3V, X5R, ceramic capacitor (0402), Murata, GRM155R60J475KE19D
C19, C22, C28, C29, C30	5	1 μ F, 6.3V, X5R, ceramic capacitor (0402), Taiyo Yuden, JMK105BJ105KA
C2, C4, C5	3	22 μ F, 6.3V, X5R, ceramic capacitor (0603), Taiyo Yuden, JMK107BBJ226MA-T
C26, C27	2	0.1 μ F \pm 20%, 10V, X5R, ceramic capacitor (0402), Taiyo-Yuden, LMK105BJ104MA
C6, C7, C8, C9, C10, C11, C13, C14, C15	9	2.2 μ F, 6.3V, X5R, ceramic capacitor (0402), Murata, GRM155R60J225ME19D
CON1	1	20-pin, right-angle connector, Sullins, PPTC102LJBN-RC

PART	QTY	DESCRIPTION
JU1, JU2, JU3, JU4, JU5, JU6, JU10, JU12, JU13, JU14	10	3-pin header, Samtec, TSW-103-07-L-S
JU7, JU8, JU9, JU11	4	2-pin header, Samtec, TSW-102-07-T-S
LB	1	0.47 μ H inductor (2016), DCR = 37m Ω , I _{SAT} = 3.5A, TOKO, DFE201610-H-R47N
LBB	1	1 μ H \pm 30% inductor (2016), DCR = 60m Ω , I _{SAT} = 3.6A, TDK, TFM201610GHM-1R0MTAA
R1	1	100k Ω resistor (0402)
R2, R3	2	2.2k Ω resistor (0402)
U1	1	PMIC (49 WLP) MAXIM, MAX77826
U2	1	Voltage Regulator (5 SC70), MAXIM, MAX8511EXK18+

Component Suppliers

SUPPLIER	PHONE	WEBSITE
TDK	847-803-6100	www.comopnent.tdk.com
Murata	770-436-1300	www.murata-northamerica.com
Taiyo-Yuden	603-669-7587	www.t-yuden.com
Sullins Electronics Corp.	760-774-0125	www.sullinselectronics.com
Samtec	800-726-8329	www.samtec.com
Toko	847-297-0070	www.toko.com

Note: Indicate that you are using the MAX77826 when contacting these component suppliers.

Schematic and PCB

See the links for information on the schematic and PCB layout.

- [MAX77826 Schematic](#)
- [MAX77826 PCB](#)

Ordering Information

PART	TYPE
MAX77826EVKIT#	EV kit
MINIUSB+	Command Module

#Denotes RoHS compliant.

+Denotes a lead(Pb)-free/RoHS-compliant package.

Revision History

REVISION NUMBER	REVISION DATE	DESCRIPTION	PAGES CHANGED
0	6/15	Initial release	—

For pricing, delivery, and ordering information, please contact Maxim Direct at 1-888-629-4642, or visit Maxim Integrated's website at www.maximintegrated.com.

Maxim Integrated cannot assume responsibility for use of any circuitry other than circuitry entirely embodied in a Maxim Integrated product. No circuit patent licenses are implied. Maxim Integrated reserves the right to change the circuitry and specifications without notice at any time.

D

D

C

C

B

B

A

A

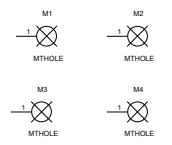
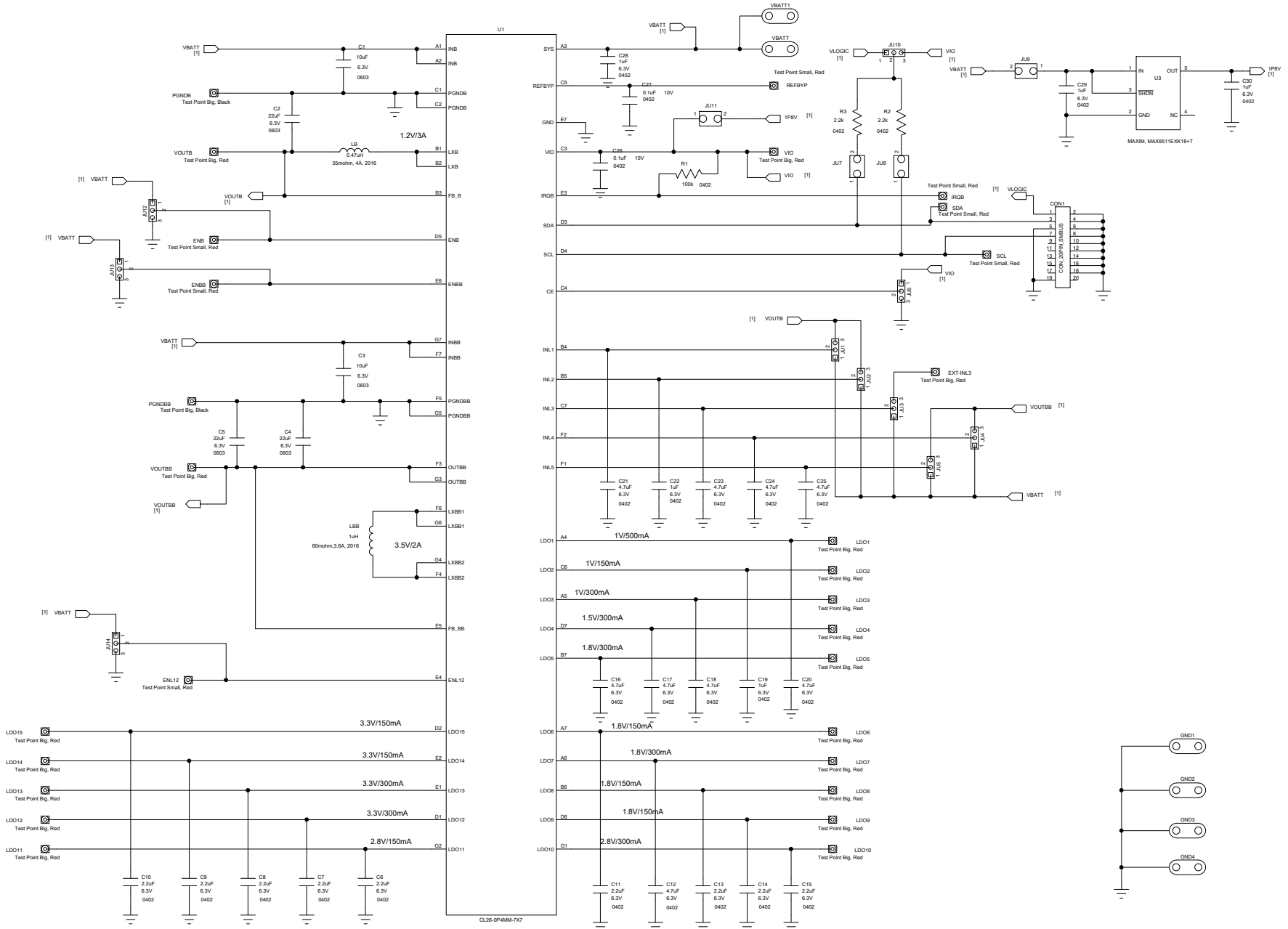

DRAWN:	DATED:
CHECKED:	DATED:
QUALITY CONTROL:	DATED:
RELEASED:	DATED:

COMPANY: MAXIM INTEGRATED

TITLE: MAX77826 EV KIT SCH

CODE:	SIZE:	DRAWING NO.:	REV:
	C		P0
SCALE:	SHEET: 8		1

MAX77826 EVAL BOARD

REV
P0

PROPERTY OF



LAYER

Layer1-Top Component Layer

DATE:

ALL UNITS ARE IN 0.001"

3000.000mil

2900.000mil

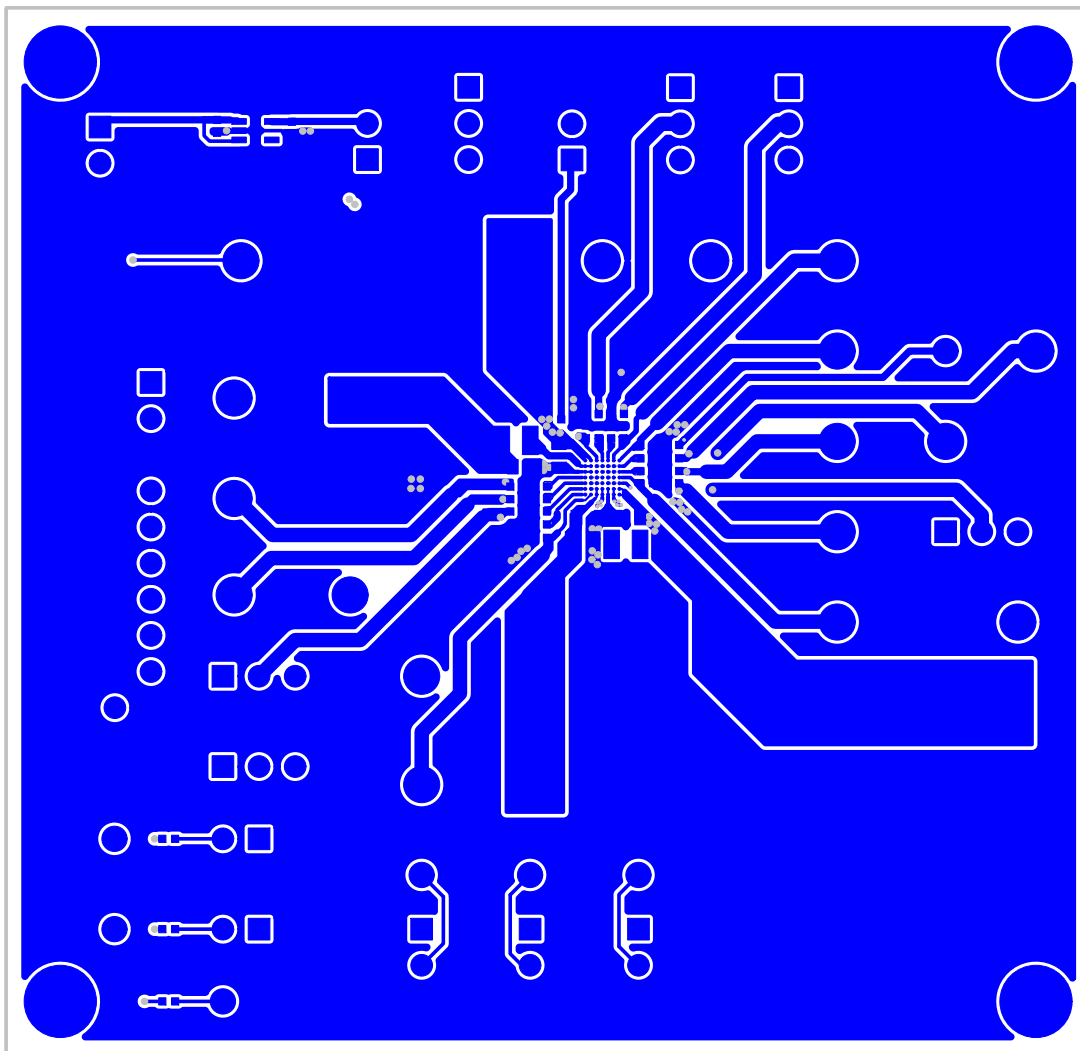

MAX77826 EVAL BOARD

REV
P0

PROPERTY OF



LAYER

Layer 2 - GND

DATE:

ALL UNITS ARE IN 0.001"

3000.000mil

2900.000mil

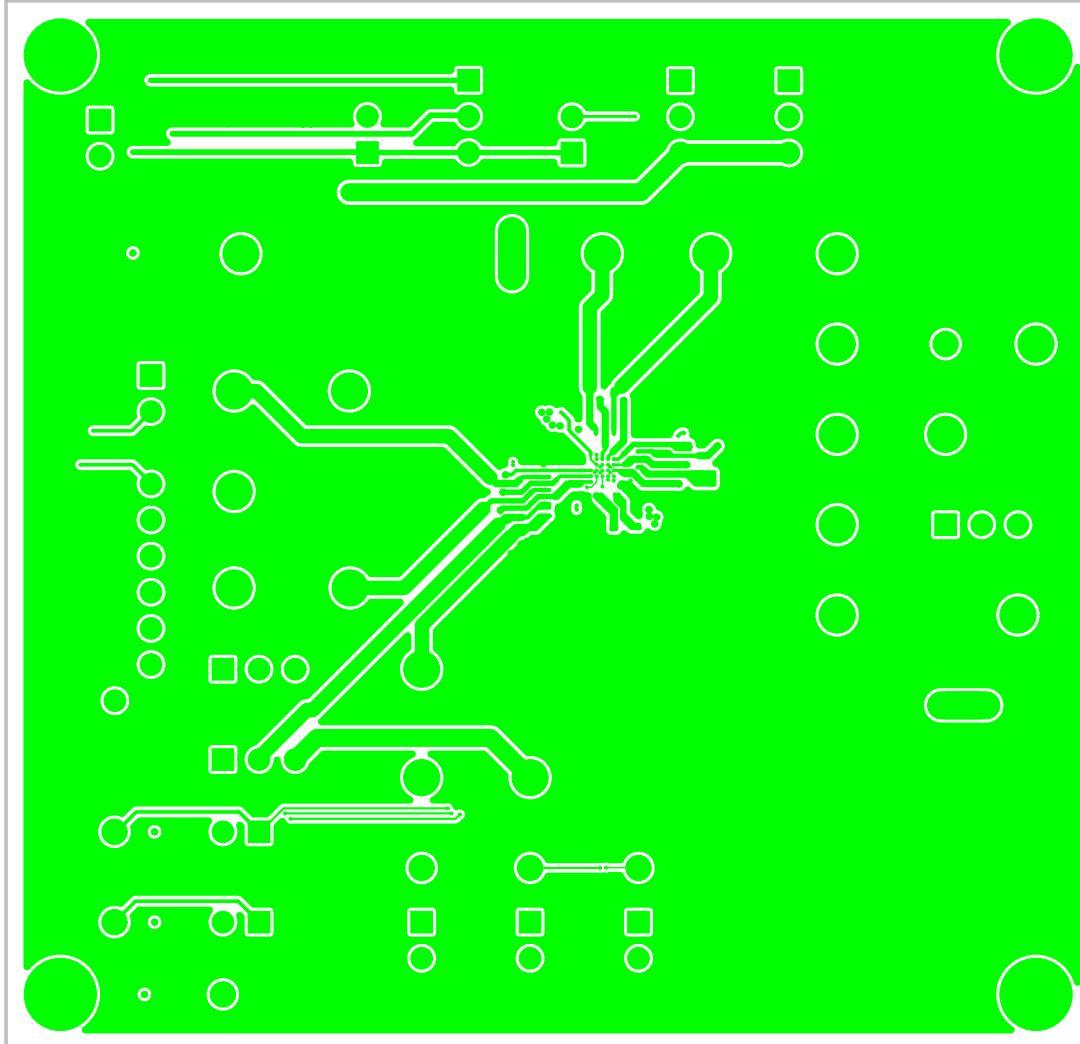

MAX77826 EVAL BOARD

REV
P0

PROPERTY OF



LAYER

Layer 3 PWR

DATE:

ALL UNITS ARE IN 0.001"

3000.000mil

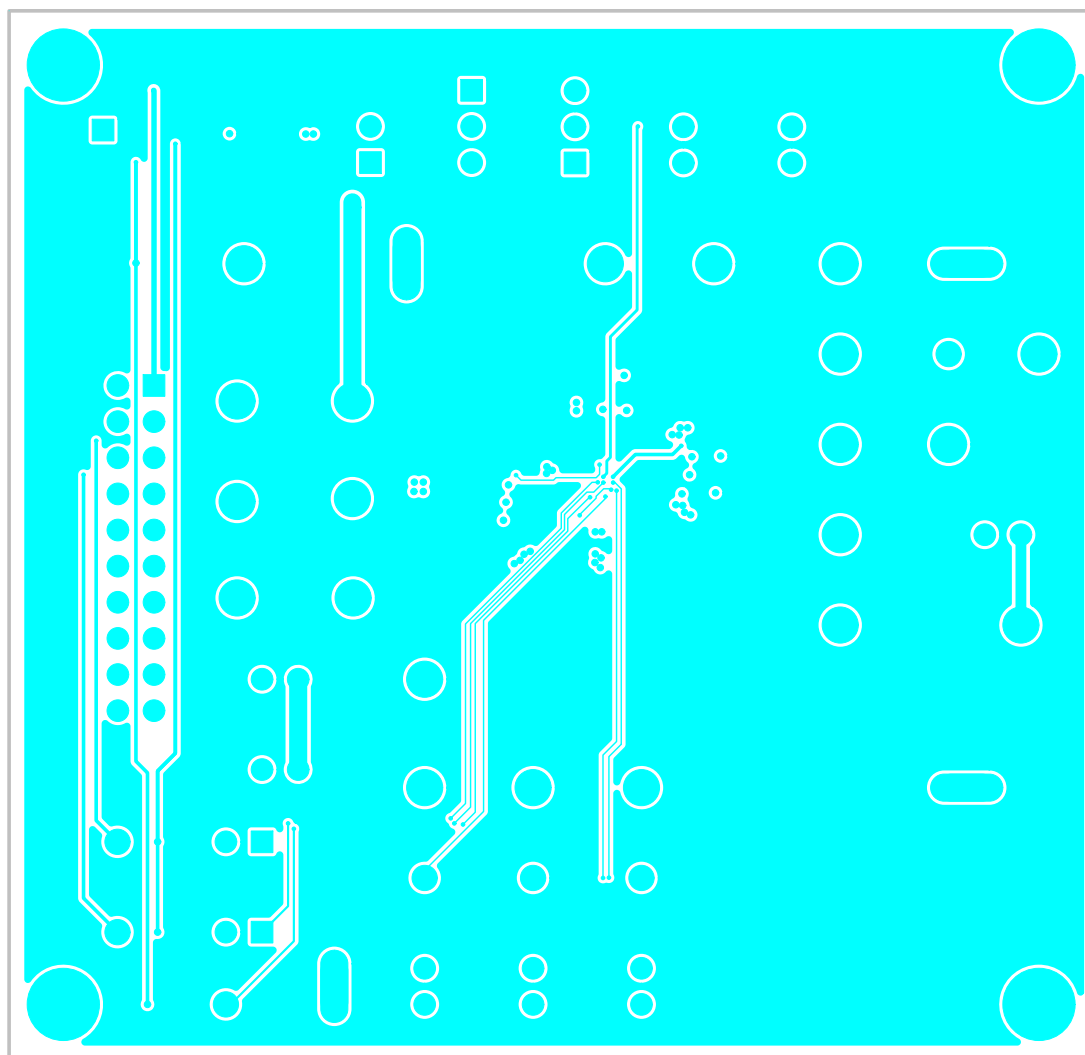

2900.000mil



MAX77826 EVAL BOARD

REV
P0

PROPERTY OF



LAYER

Layer4 -Bottom Layer -GND

DATE:

ALL UNITS ARE IN 0.001"

3000.000mil

2900.000mil

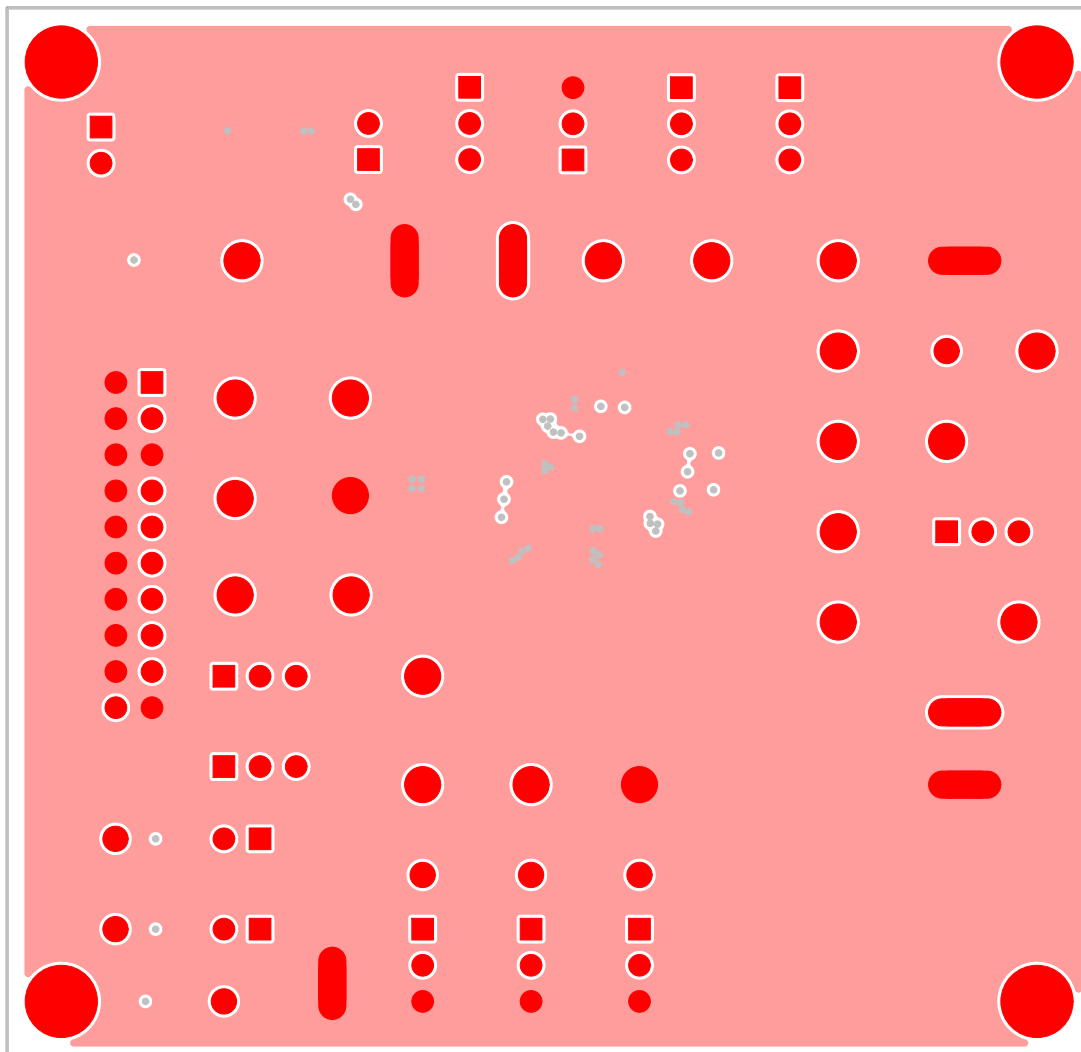

PROPERTY OF



LAYER Top SilkScreen ASSEMBLY DRAWING TOP
Layer1-Top Component Layer

DATE:

ALL UNITS ARE IN 0.001"

3000.000mil

2900.000mil

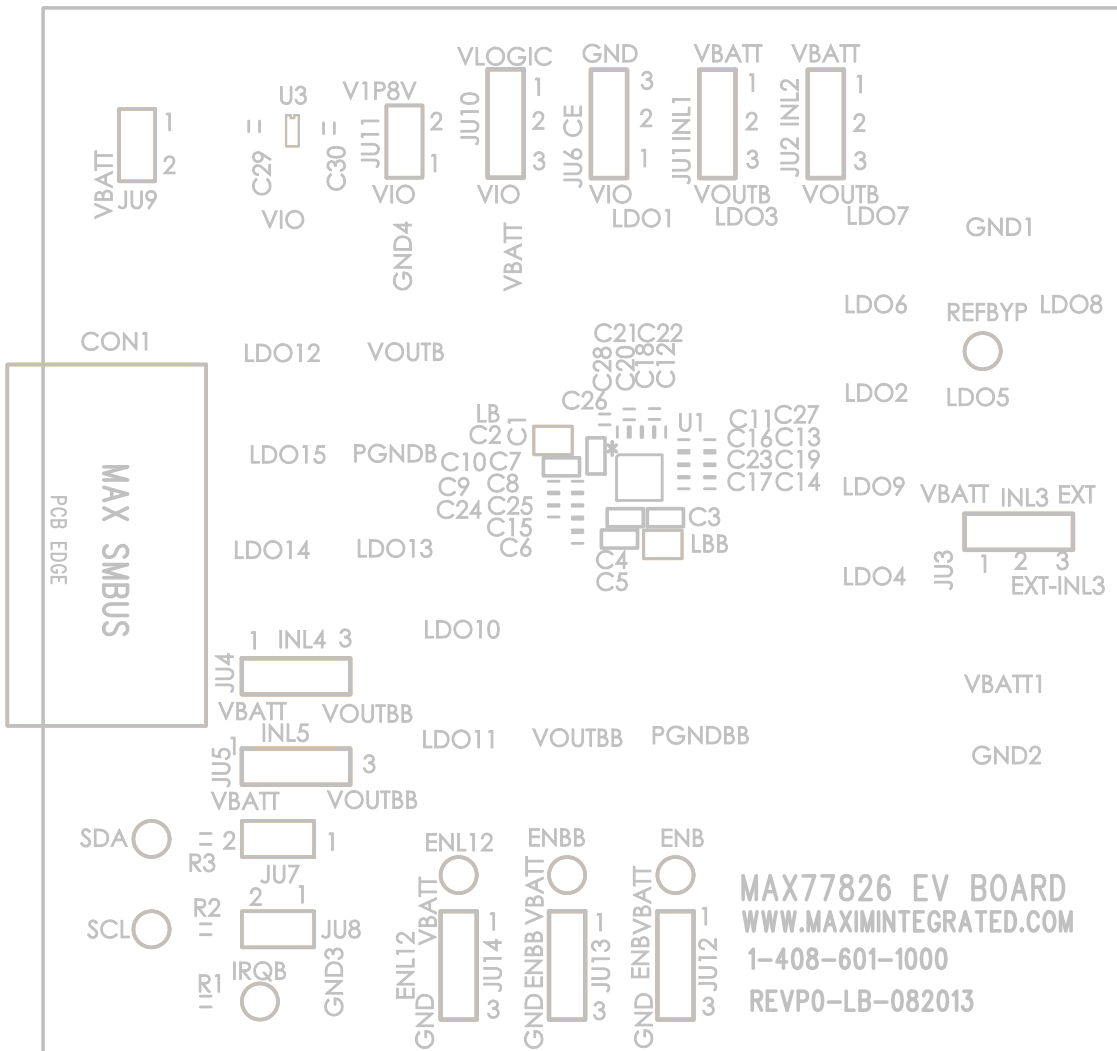

MAX77826 EV BOARD
 WWW.MAXIMINTEGRATED.COM
 1-408-601-1000
 REV P0-LB-082013